

Technical Construction File

File No.: CMTCF0401-MD

Type of Equipment:	Crushing Machine
Model No.:	OR-180S, OR-250S, OR-400S, OR-600S, OR-800S, OR-1000S, OR-180SA, OR-180SS, OR-180MS, OR-250SA, OR-250SS, OR-250MS, OR-400SA, OR-400SS, OR-400MS, OR-600SA, OR-600SS, OR-600MS, OR-800SA, OR-800SS, OR-800MS, OR-1000SA, OR-1000SS, OR-1000MS, OR-20GN, OR-24GN, OR-28GN, OR-36GN, OR-42GN, OR-50GN, OR-80GN, OR-20M, OR-24M, OR-28M, OR-36M, OR-42M, OR-50M, OR-80M
Issued Date:	2025-04-09
Brand Name/Trade mark:	---
Directive(S)	Machinery Directive 2006/42/EC
standard(s):	EN ISO 12100:2010,EN 60204-1:2018



Presented by

Luohe Orange Mechanical Equipment Co., Ltd
No.1016, Dahe Garden, Taihangshan Road, Yancheng District, Luohe,
Henan, China

1. Risk assessment

This risk assessment report is based on the methods in the EN ISO 12100:2010 and EN ISO 14121-2 standards, and the 4 factors S-A-G-W have been used for evaluating the level of risks.

S: Severity of possible harm

- S1: Slight (normally reversible)
- S2: Serious (normally irreversible)
- S3: Cause a few men die
- S4: Calamity or cause many men die

A: Frequency any duration of exposure

- A1: Seldom to very often
- A2: Frequent to continuous

G: Possibilities of avoidance

- G1: Possible
- G2: Impossible

W: Probability of occurrence of harm

- W1: Low
- W2: Medium
- W3: High

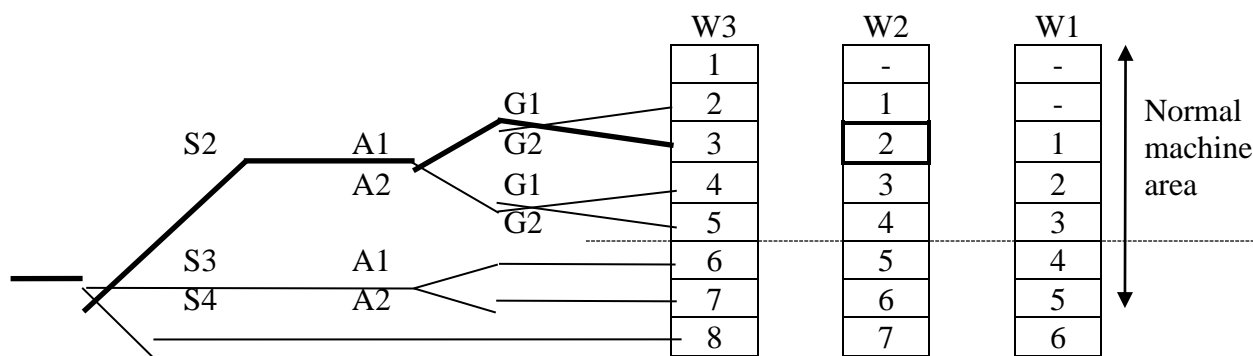

Solutions for the level of hazards

- 1: Protected by warning sign
- 2: Protected by guard and warning sign
- 3: Consider the other design, choose the best one, add both guard and warning sign
- 4: Consider another two design, choose the best one, add both guard and warning sign
- 5: Consider another three design, choose the best one, add both guard and warning sign

NO.	Hazards source	S	A	G	W	Level
Mechanical hazards						
1.0-1	Mechanical hazards due to machine parts or work pieces					
1.0-2	Mechanical hazards due to accumulation of energy inside the machinery					
1.1	Crushing	<i>1</i>	<i>1</i>	<i>1</i>	<i>1</i>	-
1.2	Shearing					
1.3	Cutting or severing					
1.4	Entanglement	<i>1</i>	<i>1</i>	<i>1</i>	<i>1</i>	-
1.5	Drawing-in or trapping	<i>1</i>	<i>1</i>	<i>1</i>	<i>1</i>	-

1.6	Impact	<i>1</i>	<i>1</i>	<i>1</i>	<i>1</i>	-
1.7	Stabbing or puncture					
1.8	Friction or abrasion					
1.9	High pressure fluid injection or ejection					
Electrical hazards						
2.1	Contact with live parts	<i>2</i>	<i>1</i>	<i>1</i>	<i>1</i>	<i>1</i>
2.2	Contact with parts which have become live under faulty conditions	<i>2</i>	<i>1</i>	<i>1</i>	<i>1</i>	<i>1</i>
2.3	Approach to live part under high voltage					
2.4	Electrostatic phenomena					
2.5	Thermal radiation or other phenomena such as projection of molten particles and chemical effects from short-circuits, overloads etc.					
Thermal hazards						
3.1	Burns, scalds and other injuries by a possible contact of persons with objects or materials with an extreme high or low temperature, by flames or explosions and also by the radiation of heat sources					
3.2	Damage to health by hot or cold working environment					
Hazards generated by noise						
4.1	Hearing loss (deafness), other physiological disorders	<i>1</i>	<i>1</i>	<i>1</i>	<i>1</i>	-
4.2	Interference with speech communication, acoustic signals, etc.	<i>1</i>	<i>1</i>	<i>1</i>	<i>1</i>	-
Hazards generated by vibration						
5.1	Use of hand-help machines resulting in a variety of neurological and vascular disorder					
5.2	Whole body vibration, particular when combined with poor postures					
Hazards generated by radiation						
6.1	Low frequency, radio frequency radiation, microwaves					
6.2	Infrared, visible and ultraviolet light					
6.3	X and gamma rays					
6.4	Alpha, beta rays, electron or ion beams, neutrons					
6.5	Lasers					
Hazards generated by materials and substances processed or used by the machinery						
7.1	Hazards from contact with or inhalation of harmful fluids, gases, mists, fumes and dusts					
7.2	Fire and explosion hazard					
7.3	Biological and micro-biological (viral or bacterial) hazards					
Hazards generated by neglecting ergonomic principles in machine design						
8.1	Unhealthy postures or excessive effort					
8.2	Inadequate consideration of hand-arm or foot-leg anatomy					
8.3	Neglected use of personal protection equipment					
8.4	Inadequate local lighting					
8.5	Mental overload or underload, stress					
8.6	Human error, human behavior	<i>1</i>	<i>1</i>	<i>1</i>	<i>1</i>	-
8.7	Inadequate design, location or identification of manual controls					
Combination of hazards						
9	Combination of hazards					

Unexpected start-up, unexpected overrun/over-speed						
10.1	Failure/disorder of the control system	<i>1</i>	<i>1</i>	<i>1</i>	<i>1</i>	-
10.2	Restoration of energy on supply after an interruption					
10.3	External influences on electrical equipment					
10.4	Other external influences (gravity, wind, etc.)					
10.5	Errors in the software					
10.6	Error made by the operator (due to mismatch of machinery with human characteristics and abilities, see 8.6)					
Impossibility of stopping the machine in the best possible conditions						
11	Impossibility of stopping the machine in the best possible conditions					
Variations in the rotational speed of tools						
12	Variations in the rotational speed of tools					
Failure of the power supply						
13	Failure of the power supply					
Failure of the control circuit						
14	Failure of the control circuit	<i>1</i>	<i>1</i>	<i>1</i>	<i>1</i>	-
Errors of fitting						
15	Errors of fitting	<i>1</i>	<i>1</i>	<i>1</i>	<i>1</i>	-
Break-up during operation						
16	Break-up during operation					
Falling or ejected objects or fluids						
17	Falling or ejected objects or fluids					
Loss of stability / overturning of machinery						
18	Loss of stability / overturning of machinery					
Slip, trip and fall of persons (related to machinery)						
19	Slip, trip and fall of persons(related to machinery)					
Additional hazards, hazardous situations and hazardous events due to mobility						
20	Relating to the traveling function					
20.1	Movement when starting the engine					
20.2	Movement without a driver at the driving position					
20.3	Movement without all parts in a safe position					
20.4	Excessive speed of pedestrian controlled machinery					
20.5	Excessive oscillations when moving					
20.6	Insufficient ability of machinery to be slowed down, stopped and immobilised					
Linked to the work position (including driving station) on the machine						
21.1	Fall of persons during access to (or at/from) the work position					
21.2	Exhaust gases/lack of oxygen at the work position					
21.3	Fire (flammability of the cab, lack of extinguishing means)					
21.4	Mechanical hazards at the work position: contact with the wheels; rollover; fall of objects, penetration by objects; break-up of parts rotation at high speed; contact of persons with machine parts or tools (pedestrian controlled machines)					
21.5	Insufficient visibility form the work positions					

21.6	Inadequate lighting					
21.7	Inadequate seating					
21.8	Noise at the work position					
21.9	Vibration at the work position					
21.10	Insufficient means for evacuation/emergency exit					
Due to the control system						
22.1	Inadequate location of manual controls					
22.2	Inadequate design of manual controls and their mode of operation					
Form handling the machine (lack of stability)						
23	Form handling the machine (lack of stability)					
Due to the power source and to the transmission of power						
24.1	Hazards form the engine and the batteries					
24.2	Hazards form the transmission of power between machines					
24.3	Hazards form coupling and towing					
Form/to third persons						
25.1	Unauthorized start-up/use					
25.2	Drift of a part away from its stopping position					
25.3	Lack or inadequacy of visual or acoustic warning means					
Insufficient instructions for the driver/operator						
26	Insufficient instructions for the driver/operator					
Additional hazards, hazardous situations and hazardous events due to lifting						
27	Mechanical hazards and hazardous events					
27.1	Form load falls, collisions, machine tipping caused by:					
27.1.1	Lack of stability					
27.1.2	Uncontrolled loading-overloading-overturning moments exceeded					
27.1.3	Uncontrolled amplitude of movements					
27.1.4	Unexpected/unintended movement of loads					
27.1.5	Inadequate holding devices/accessories					
27.1.6	Collision of more then one machine					
27.2	Form access of persons to load support					
27.3	Form derailment					
27.4	Form insufficient mechanical strength of parts					
27.5	Form inadequate selection of chains, ropes, lifting and accessories and their inadequate integration into the machine					
27.6	Form inadequate selection of chains, ropes, lifting and accessories and their inadequate integration into the machine					
27.7	Form lowering of the load under the control of friction brake					
27.8	Form abnormal conditions of assembly/testing/use/maintenance					
27.9	Form the effect of load on persons (impact by load or counterweight)					
Electrical hazards						
28.1	Form lightning					
Hazards generated by neglecting ergonomic principles						
29.1	Insufficient visibility from the driving position					
Additional hazards, hazardous and situations and hazardous events due to underground work						

30	Mechanical hazards and hazardous events due to:					
30.1	Lack of stability of powered roof supports					
30.2	Failing accelerator or brake control of machinery running on rails					
30.3	Failing or lack of dead man's control of machinery running on rails					
31	Restricted movement of persons					
32	Fire and explosion					
33	Emission of dust, gases etc.					
Additional hazards, hazardous situations and hazardous events due to the lifting or moving of persons						
34	Mechanical hazards and hazardous events due to:					
34.1	Inadequate mechanical strength-inadequate working coefficients					
34.2	Failing of loading control					
34.3	Failing of controls in person carrier (function, priority)					
34.4	Over speed of person carrier					
35	Falling of person from person carrier					
36	Falling or overturning of person carrier					
37	Human error, human behavior					
NO.	Hazards source	S	A	G	W	Level
1.1	Crushing	<i>I</i>	<i>I</i>	<i>I</i>	<i>I</i>	-
Where	Near machine					
When	<i>loading/unloading,maintenance</i>					
Improvement result						
	Method	S	A	G	W	Level
	<i>1. Affixing suitable warning signs. 2. Only operation by training/authorized persons. 3. Operation of the machine shall conform to the instructions of the instruction manual. 4. Check and inspection according to the specified durations of the instruction manual. 5. Provide guards.</i>	<i>I</i>	<i>I</i>	<i>I</i>	<i>I</i>	-

NO.	Hazards source	S	A	G	W	Level
1.4	Entanglement	<i>I</i>	<i>I</i>	<i>I</i>	<i>I</i>	-
Where	Contact with roller of the machine					
When	<i>during operation, inspection and maintenance of machine</i>					
Improvement result						
	Method	S	A	G	W	Level
	<i>1. Affixing suitable warning signs. 2. Only operation by training/authorized persons. 3. Operation of the machine shall conform to the instructions of the instruction manual. 4. Check and inspection according to the specified durations of the instruction manual. 5. Provide guards.</i>	<i>I</i>	<i>I</i>	<i>I</i>	<i>I</i>	-

NO.	Hazards source	S	A	G	W	Level
1.5	Drawing-in or trapping	<i>1</i>	<i>1</i>	<i>1</i>	<i>1</i>	-
Where	Contact with the conveyor of the machine					
When	<i>during operation, inspection and maintenance of machine</i>					
Improvement result						
Method		S	A	G	W	Level
1. Affixing suitable warning signs. 2. Only operation by training/authorized persons. 3. Operation of the machine shall conform to the instructions of the instruction manual. 4. Check and inspection according to the specified durations of the instruction manual. 5. Provide guards.		<i>1</i>	<i>1</i>	<i>1</i>	<i>1</i>	-

NO.	Hazards source	S	A	G	W	Level
1.6	Impact	<i>1</i>	<i>1</i>	<i>1</i>	<i>1</i>	-
Where	<i>moving/rotating tool</i>					
When	<i>during operation, inspection and maintenance of machine</i>					
Improvement result						
Method		S	A	G	W	Level
1. Affixing suitable warning signs. 2. Only operation by training/authorized persons. 3. Operation of the machine shall conform to the instructions of the instruction manual. 4. Check and inspection according to the specified durations of the instruction manual. 5. Provide guards.		<i>1</i>	<i>1</i>	<i>1</i>	<i>1</i>	-

NO.	Hazards source	S	A	G	W	Level
2.1	Contact with live parts	<i>2</i>	<i>1</i>	<i>1</i>	<i>1</i>	<i>1</i>
Where	<i>contact with live parts or connections</i>					
When	<i>During commissioning, maintenance</i>					
Improvement result						
Method		S	A	G	W	Level
1. Only operation by training/authorized persons. 2. Operation of the machine shall conform to the instructions of the instruction manual. 3. Check and inspection according to the specified durations of the instruction manual. 4. Using safety components in accordance with those relevant international standards. 5. Use of warning label.		<i>1</i>	<i>1</i>	<i>1</i>	<i>1</i>	-

NO.	Hazards source	S	A	G	W	Level
2.2	Contact with parts which have become live under faulty conditions	<i>2</i>	<i>1</i>	<i>1</i>	<i>1</i>	<i>1</i>
Where	<i>contact with live parts or connections</i>					
When	<i>during operation, inspection and maintenance of machine</i>					
Improvement result						
Method		S	A	G	W	Level

1. Only operation by training/authorized persons. 2. Operation of the machine shall conform to the instructions of the instruction manual. 3. Check and inspection according to the specified durations of the instruction manual. 4. Using safety components in accordance with those relevant international standards. 5. Use of warning label.	<i>I</i>	<i>I</i>	<i>I</i>	<i>I</i>	-
---	----------	----------	----------	----------	---

NO.	Hazards source	S	A	G	W	Level
4.1	Hearing loss (deafness), other physiological disorders	<i>I</i>	<i>I</i>	<i>I</i>	<i>I</i>	-
Where	<i>Near machine</i>					
When	<i>during operation, inspection and maintenance of machine</i>					
Improvement result						
Method		S	A	G	W	Level
1. Only operation by training/authorized persons. 2. Operation of the machine shall conform to the instructions of the instruction manual. 3. Check and inspection according to the specified durations of the instruction manual. 4. Using safety components in accordance with those relevant international standards. 5. Use of warning label.		<i>I</i>	<i>I</i>	<i>I</i>	<i>I</i>	-

NO.	Hazards source	S	A	G	W	Level
4.2	Interference with speech communication, acoustic signals, etc.	<i>I</i>	<i>I</i>	<i>I</i>	<i>I</i>	-
Where	<i>Near machine</i>					
When	<i>during operation, inspection and maintenance of machine</i>					
Improvement result						
Method		S	A	G	W	Level
1. Only operation by training/authorized persons. 2. Use of warning label. 3. Use the PPE.		<i>I</i>	<i>I</i>	<i>I</i>	<i>I</i>	-

NO.	Hazards source	S	A	G	W	Level
8.6	Human error, human behavior	<i>I</i>	<i>I</i>	<i>I</i>	<i>I</i>	-
Where	<i>At load/unload, tool mounting positions</i>					
When	<i>Reasonably foreseeable misuse, inadvertent operation of controls, incorrect work material and cutter handling and setting during loading/unloading, process control, tool handling.</i>					
Improvement result						
Method		S	A	G	W	Level
1. Only authorized person can use the machine. 2. Training before using this machine. 3. Make reference to the instruction manual before using this machine.		<i>I</i>	<i>I</i>	<i>I</i>	<i>I</i>	-

NO.	Hazards source	S	A	G	W	Level
10.1	Failure/disorder of the control system	<i>1</i>	<i>1</i>	<i>1</i>	<i>1</i>	-
Where	<i>the control system of the machine</i>					
When	<i>Mechanical hazards associated with selected machine movement during setting, cleaning</i>					
Improvement result						
Method		S	A	G	W	Level
<ol style="list-style-type: none"> 1. Only authorized person can use the machine. 2. Make reference to the instruction manual before using this machine. 3. Check before operation. 4. Periodic maintenance. 		<i>1</i>	<i>1</i>	<i>1</i>	<i>1</i>	-

NO.	Hazards source	S	A	G	W	Level
14	Failure of the control circuit	<i>1</i>	<i>1</i>	<i>1</i>	<i>1</i>	-
Where	<i>In the wireway</i>					
When	<i>Unexpected movements of machine during setting, cleaning or maintenance</i>					
Improvement result						
Method		S	A	G	W	Level
<ol style="list-style-type: none"> 1. Checking before operation. 2. Make reference to the instruction manual before operate this machine. 3. Daily/periodic inspection and maintenance. 		<i>1</i>	<i>1</i>	<i>1</i>	<i>1</i>	-

NO.	Hazards source	S	A	G	W	Level
15	Errors of fitting	<i>1</i>	<i>1</i>	<i>1</i>	<i>1</i>	-
Where	<i>At machine</i>					
When	<i>machine elements fail or swing unexpectedly during process control, tool mounting, maintenance</i>					
Improvement result						
Method		S	A	G	W	Level
<ol style="list-style-type: none"> 1. Only authorized person can use the machine. 2. Make reference to the instruction manual before using this machine. 3. Check before operation. 4. Periodic maintenance. 		<i>1</i>	<i>1</i>	<i>1</i>	<i>1</i>	-

EN ISO 12100:2010			
Clause	Requirement-Test	Result-Remark	Verdict
6	Risk reduction		P
6.1	General		P
	The objective of risk reduction can be achieved by the elimination of hazards, or by separately or simultaneously reducing each of the two elements that determine the associated risk: -severity of harm from the hazard under consideration; - probability of occurrence of that harm. All protective measures intended for reaching this objective shall be applied in the following sequence, referred to as the three-step method (see also Figures 1 and 2).	Appropriate machine design has been performed by the manufacturer	P
6.2	Inherently safe design measures		P
6.2.1	General		P
	Inherently safe design measures are the first and most important step in the risk reduction process because protective measures inherent to the characteristics of the machine are likely to remain effective, whereas experience has shown that even well-designed safeguarding may fail or be violated and information for use may not be followed.	Appropriate machine design has been performed by the manufacturer.	P
	Inherently safe design measures are achieved by avoiding hazards or reducing risks by a suitable choice of design features of the machine itself and/or interaction between the exposed persons and the machine. NOTE See 6.3 for safeguarding and complementary measures that can be used to achieve the risk reduction objectives in the case where inherently safe design measures are not sufficient (see 6.1 for the three-step method).	Appropriate machine design has been performed by the manufacturer.	P
6.2.2	Consideration of geometrical factors and physical aspects		P
6.2.2.1	Geometrical factors		P
	Such factors include the following.		
	a) The form of machinery is designed to maximize direct visibility of the working areas and hazard zones from the control position — reducing blind spots, for example — and choosing and locating means of indirect vision where necessary (mirrors, etc.) so as to take into account the characteristics of human vision, particularly when safe operation requires permanent direct control by the	Reducing blind spots	P

EN ISO 12100:2010			
Clause	Requirement-Test	Result-Remark	Verdict
	operator, for example: -the travelling and working area of mobile machines; -the zone of movement of lifted loads or of the carrier of machinery for lifting persons; -the area of contact of the tool of a hand-held or hand-guided machine with the material being worked. The design of the machine shall be such that, from the main control position, the operator is able to ensure that there are no exposed persons in the danger zones.		
	b) The form and the relative location of the mechanical components parts: for instance, crushing and shearing hazards are avoided by increasing the minimum gap between the moving parts, such that the part of the body under consideration can enter the gap safely, or by reducing the gap so that no part of the body can enter it (see ISO 13854 and ISO 13857).	By increasing the minimum gap between the moving parts or by reducing the gap.	P
	c) Avoiding sharp edges and corners, protruding parts: in so far as their purpose allows, accessible parts of the machinery shall have no sharp edges, no sharp angles, no rough surfaces, no protruding parts likely to cause injury, and no openings which can “trap” parts of the body or clothing. In particular, sheet metal edges shall be deburred, flanged or trimmed, and open ends of tubes which can cause a “trap” shall be capped.	No sharp edges, no sharp angles, no rough surfaces, no protruding parts.	P
	d) The form of the machine is designed so as to achieve a suitable working position and provide accessible manual controls (actuators).	Suitable working position, accessible manual controls.	P
6.2.2.2	Physical aspects		P
	Such aspects include the following:		
	a) limiting the actuating force to a sufficiently low value so that the actuated part does not generate a mechanical hazard;	The actuating force has been limited to be a sufficiently low value.	P
	b) limiting the mass and/or velocity of the movable elements, and hence their kinetic energy;	The mass of the tool has been limited.	P
	c) limiting the emissions by acting on the characteristics of the source using measures for reducing: 1) noise emission at source (see ISO/TR 11688-1), 2) the emission of vibration at source, such as redistribution or addition of mass and changes of process parameters [for example, frequency and/or amplitude of movements (for hand-held and hand-guided machinery, see CR 1030-1)], 3) the emission of hazardous substances, including the use of less hazardous substances or dust-reducing processes (granules instead of powders, milling instead		P

EN ISO 12100:2010			
Clause	Requirement-Test	Result-Remark	Verdict
	of grinding), and 4) radiation emissions, including, for example, avoiding the use of hazardous radiation sources, limiting the power of radiation to the lowest level sufficient for the proper functioning of the machine, designing the source so that the beam is concentrated on the target, increasing the distance between the source and the operator or providing for remote operation of the machinery [measures for reducing emission of non-ionizing radiation are given in 6.3.4.5 (see also EN 12198-1 and EN 12198-3)].		
6.2.3	Taking into account the general technical knowledge regarding machine design		P
	This general technical knowledge can be derived from technical specifications for design (e.g. standards, design codes, calculation rules). These should be used to cover :		
	a) mechanical stresses such as - stress limitation by implementation of correct calculation, construction and fastening methods as regards, e.g. bolted assemblies, welded assemblies - stress limitation by overload prevention, (e.g. “fusible” plugs, pressure-limiting valve, breakage points, torque-limiting devices); - avoiding fatigue in elements under variable stresses (notably cyclic stresses); - static and dynamic balancing of rotating elements;	The appropriate technical knowledge of mechanical has been taken into account.	P
	b) materials and their properties such as - resistance to corrosion, ageing, abrasion and wear; - hardness, ductility, brittleness; - homogeneity; - toxicity; - flammability.	The materials have been treated by appropriate methods.	P
	c) emission values for : - noise; - vibration; - hazardous substances; - radiation.		P
	When the reliability of particular components or assemblies is critical for safety (e.g. ropes, chains, lifting accessories for lifting loads or persons), stress values shall be multiplied by appropriate working coefficients.	Appropriate working coefficients have been taken into account during design and calculation.	P
6.2.4	Choice of an appropriate technology		N

EN ISO 12100:2010			
Clause	Requirement-Test	Result-Remark	Verdict
	One or more hazards can be eliminated or risks reduced by the choice of the technology to be used in certain applications, e.g. :		-
	a) on machines intended for use in explosive atmospheres: - fully pneumatic or hydraulic control system and machine actuators; - “intrinsically safe” electrical equipment (see IEC 60079-11)		N
	b) for particular products to be processed such as a solvent: equipment assuring that the temperature will remain far below the flash point.		N
	c) alternative equipment to avoid high noise level, e.g.: - electrical instead of pneumatic equipment - in certain conditions, water cutting instead of mechanical equipment.		N
6.2.5	Applying the principle of the positive mechanical action		P
	Positive mechanical action is achieved when a moving mechanical component inevitably moves another component along with it, either by direct contact or via rigid elements. An example of this is positive opening operation of switching devices in an electrical circuit (see IEC 60947-5-1 and ISO 14119).		P
6.2.6	Provisions for stability		P
	Machines shall be designed to have sufficient stability to allow them to be used safely in their specified conditions of use.	These machines have been designed to have sufficient stability .	P
	Factors to be taken into account include		-
	- geometry of the base;	The factor has been taken into account during design.	P
	- weight distribution, including loading;	The factor has been taken into account during design.	P
	- dynamic forces due to movements of parts of the machine, of the machine itself, or of elements held by the machine which may result in an overturning moment;	The factor has been taken into account during design.	P
	- vibration	The factor has been taken into account during design.	P
	- oscillations of the centre of gravity;	The factor has been taken into account	P

EN ISO 12100:2010			
Clause	Requirement-Test	Result-Remark	Verdict
		during design	
	- characteristics of the supporting surface in case of traveling or installation on different sites (e.g. ground conditions, slope);	The factor has been taken into account during design.	P
	- external forces (e.g. wind pressure, manual forces)	The factor has been taken into account during design.	P
	Stability shall be considered in all phases of the life of the machine, including handling, traveling, installation, use, de-commissioning and dismantling.	The factor has been taken into account during design.	P
	Other protective measures for stability relevant to safeguarding are given in 6.3.2.6	Please see the related clause.	P
6.2.7	Provision for maintainability		P
	When designing a machine, the following maintainability factors shall be taken into account:		-
	- accessibility, taking into account the environment and the human body measurements, including the dimensions of the working clothes and tools used;	These factors have been taken into account during design.	P
	- ease of handling, taking into account human capabilities;	The factor has been taken into account during design.	P
	- limitation of the number of special tools and equipment;	The factor has been taken into account during design.	P
6.2.8	Observing ergonomic principles		P
	Ergonomic principles shall be taken into account in designing machinery to reduce mental or physical stress and strain of the operator.	Appropriate ergonomic principles have been taken into account in designing machinery.	P
	These principles shall be considered when allocating functions to operator and machine (degree of automation) in the basic design.	These principles have been taken into account during allocating functions to operator and machine.	P
	Account shall be taken of body sizes likely to be found in the intended user population, strengths and postures, movement amplitudes, frequency of cyclic actions (see ISO 10075 and ISO 10075-2)	All these factors have been taken into account during design.	P
	All elements of the “operator-machine” interface such as controls, signaling or data display elements, shall be	All arrangement and design of manual	P

EN ISO 12100:2010			
Clause	Requirement-Test	Result-Remark	Verdict
	designed to be easily understood so that clear and unambiguous interaction between the operator and the machine is possible.(see EN 614-1, ISO 6385, EN 13861 and IEC 61310-1)	controls have been checked in compliance with.	
	Designer's attention is especially drawn to following ergonomic aspects of machine design		-
	a) Avoiding stressful postures and movements during use of the machine (e.g. by providing facilities to adjust the machine to suit the various operators).	Stressful postures and movements during use of the machine have been avoided.	P
	b) Designing machines, and more especially hand-held and mobile machines to enable them to be operated easily taking into account human effort, actuation of controls and hand, arm and leg anatomy.	This machine has been adjusted to the human strength and convenient movement.	P
	c) Limit as far as possible noise, vibration and thermal effects such as extreme temperatures.	This machine has been designed with low noise, vibration.	P
	d) Avoid linking the operator's working rhythm to an automatic succession of cycles.	This situation has been avoided.	P
	e) Select, locate and identify manual controls (actuators) so that		-
	- they are clearly visible and identifiable and appropriately marked where necessary (see 6.4.4)	Clearly visible and appropriately marked	P
	- they can be safely operated without hesitation or loss of time and without ambiguity (e.g. a standard layout of controls reduces the possibility of error when an operator changes from a machine to another one of similar type having the same pattern of operation)	Standard layout of controls. See the photos.	P
	- their location(for push-buttons) and their movement (for levers and handwheels) are consistent with their effect (see IEC 61310-3)		P
	- their operation cannot cause additional risk		P
	Where a control is designed and constructed to perform several different actions, namely where there is no one-to-one correspondence (e.g. keyboards), the action to be performed shall be clearly displayed and subject to confirmation where necessary.	one-to-one correspondence	N
	Controls shall be so arranged that their layout, travel and resistance to operation are compatible with the action to be performed, taking account of ergonomic principles.	Taking account of ergonomic principles	P
	Constraints due to the necessary or foreseeable use of		P

EN ISO 12100:2010			
Clause	Requirement-Test	Result-Remark	Verdict
	personal protective equipment(such as footwear, gloves)shall be taken into account.		
	f) Select, design and locate indicators, dials and visual display units so that		-
	- they fit within the parameters and characteristics of human perception		P
	- information displayed can be detected, identified and interpreted conveniently, i.e. long lasting, distinct, unambiguous and understandable with respect to the operator's requirements and the intended use;	All the information displayed comply with this requirement.	P
	- the operator is able to perceive them form the control position		P
6.2.9	Preventing electrical hazard		P
	For the design of the electrical equipment of machines EN 60204-1 gives general provisions, especially in clause 6 for protection against electric shock.	See the test report of EN 60204-1	P
	For requirements related to specific machines, see corresponding IEC standards (e.g. series of IEC 61029, IEC 60745, IEC 60335).		N
6.2.10	Preventing and hydraulic hazards		N
	Pneumatic and hydraulic equipment of machinery shall be designed so that :		-
	- the maximum rated pressure cannot be exceeded in the circuits (e.g. by means of pressure limiting devices)		N
	- no hazard results from pressure surges or rises, pressure losses or drops or losses of vacuum;		N
	- no hazardous fluid jet or sudden hazardous movement of the hose (whiplash)results from leakage or component failures;		N
	- air receivers, air reservoirs or similar vessels (e.g. in gas loaded accumulators) comply with the design rules for these elements;		N
	- air elements of the equipment, and especially pipes and hoses, be protected against harmful external effects;		N
	- as far as possible, reservoirs and similar vessels (e.g. in gas loaded accumulators)are automatically depressurized when isolating the machine from its power supply (see 6.3.5.4) and, if it is not possible, means are provided for their isolation, local depressurizing and pressure indication (see also ISO 14118:2000, clause 5)		N
	- all elements which remain under pressure after		N

EN ISO 12100:2010			
Clause	Requirement-Test	Result-Remark	Verdict
	isolation of the machine from its power supply be provided with clearly identified exhaust devices, and a warning label drawing attention to the necessity of depressurizing those elements before any setting or maintenance activity on the machine. See also ISO 4413 and ISO4414		
6.2.11	Applying inherently safe design measures to control system		P
6.2.11.1	General		P
	The design measures of the control system shall be chosen so that their safety-related performance provides a sufficient amount of risk reduction (see ISO 13849-1 or IEC 62061)	Inherently safe design measures to control system have applied.	P
	The correct design of machine control systems can avoid unforeseen and potentially hazardous machine behaviour.	Inherently safe design measures to control system have applied.	P
	Typical causes of hazardous machine behavior are :		-
	- an unsuitable design or modification (accidental or deliberate) of the control system logic;	No this kind of hazard in this machine	N
	- a temporary or permanent defect or a failure of one or several components of the control system;		N
	- a variation or a failure in the power supply of the control system;	No this kind of hazard in this machine	N
	- inappropriate selection, design and location of the control devices;	No this kind of hazard in this machine	N
	Typical examples of hazardous machine behaviour are :		-
	- unintended/unexpected start-up(see ISO 14118)	No this kind of hazard in this machine	N
	- uncontrolled speed change;	Speed monitor	N
	- failure to stop moving parts;	Emergency stop devices	N
	- dropping or ejection of a mobile part of the machine or of a workpiece clamped by the machine;		P
	- machine action resulting from inhibition (defeating or failure) of protective devices	No this kind of hazard in this machine	N
	In order to prevent hazardous machine behaviour and to achieve safety functions, the design of control systems shall comply with the principles and methods presented	See the related clause	P

EN ISO 12100:2010			
Clause	Requirement-Test	Result-Remark	Verdict
	in this subclause 6.2.11 and in 6.2.12.		
	These principles and methods shall be applied singly or in combination as appropriate to the circumstances (see ISO 13849-1 and EN 60204-1 and IEC 62061).	See the test report of EN 60204-1	P
	Control systems shall be designed to enable the operator to interact with the machine safely and easily; this requires one or several of the following solutions;	The operator interact with the machine safely and easily.	P
	- systematic analysis of start and stop conditions;	Systematic analysis have been applied.	P
	- provision for specific operating modes (e.g. start-up after normal stop, restart after cycle interruption or after emergency stop, removal of the workpieces contained in the machine, operation of a part of the machine in case of a failure of a machine element)	Enough provisions have been provided.	P
	- clear display of the faults;		P
	- measures to prevent accidental generation of unexpected start commands (e.g. shrouded start device) likely to cause dangerous machine behaviour (see ISO 14118:2000, figure 1)	Main switch with lock and related devices are provided.	P
	- maintained stop commands(e.g. interlock) to prevent restarting that could result in dangerous machine behaviour (see ISO 14118:2000, figure 1)	This requirement is complied with.	P
	An assembly of machines may be divided into several zones for emergency stopping, for stopping as a result of protective devices and/or for isolation and energy dissipation.		P
	The different zones shall be clearly defined and it shall be obvious which parts of the machine belong to which zone.		P
	Likewise it shall be obvious which control devices (e.g. emergency stop devices, supply disconnecting devices)and/or protective devices belong to which zone.		P
	The interfaces between zones shall be designed such that no function in one zone creates hazards in another zone which has been stopped for an intervention.		P
	Control systems shall be designed to limit the movements of parts of the machinery, the machine itself, or workpieces and/or loads held by the machinery, to the safe design parameters(e.g. range, speed, acceleration, deceleration, load capacity). Allowance shall be made for dynamic effects (e.g. the swinging of loads).	The max. speed	P
	For example:		-

EN ISO 12100:2010			
Clause	Requirement-Test	Result-Remark	Verdict
	- the traveling speed of mobile pedestrian controlled machinery other than remote-controlled shall be compatible with walking speed.		N
	- the range, speed, acceleration and deceleration of movements of the person-carrier and carrying vehicle for lifting persons shall be limited to non-hazardous values, taking into account the total reaction time of the operator and the machine.		N
	- the range of movements of parts of machinery for lifting loads shall be kept within specified limits.		P
	When machinery is designed to use synchronously different elements which can also be used independently the control system shall be designed to prevent risks due to lack of synchronization.		N
6.2.11.2	Starting of internal power source/switching on an external power supply		P
	The starting of an internal power source or switching-on of an external power supply shall not result in a hazardous situation. For example: -starting the internal combustion engine shall not lead to movement of a mobile machine; -connection to mains electricity supply shall not result in the starting of working parts of a machine. See EN 60204-1:2006, 7.5 (see also Annexes A and B).	Not result in the starting of working parts of a machine	P
6.2.11.3	Starting/stopping of a mechanism		P
	The primary action for starting or accelerating the movement of a mechanism should be performed by application or increase of voltage or fluid pressure, or, if binary logic elements are considered, by passage from state 0 to state 1 (if state 1 represents the highest energy state)	This requirement has been taken into account during design.	P
	The primary action for stopping or slowing down should be performed by removal or reduction of voltage or fluid pressure, or, if binary logic elements are considered, by passage from state 1 to state 0 (if state 1 represents the highest energy state).	The type of stopping of this machine belongs to state 1 and state 0.	P
	When, in order for the operator to maintain permanent control of deceleration, this principle is not observed (e.g. a hydraulic braking device of a self-propelled mobile machine), the machine shall be equipped with a means of slowing and stopping in case of failure of the main braking system	No such situation exist.	N
6.2.11.4	Restart after power interruption		P
	If it may generate a hazard, the spontaneous restart of a	A self-maintained	P

EN ISO 12100:2010			
Clause	Requirement-Test	Result-Remark	Verdict
	machine when it is re-energized after power interruption shall be prevented (e.g. by use of a self-maintained relay, contactor or valve).	relay	
6.2.11.5	Interruption of power supply		P
	Machinery shall be designed to prevent hazardous situations resulting from interruption or excessive fluctuation of the power supply. At least the following requirements shall be met:		P
	- the stopping function of the machinery shall remain;		P
	- all devices whose permanent operation is required for safety shall operation an effective way to maintain safety (e.g. locking, clamping devices, cooling or heating devices, power-assisted steering of self-propelled mobile machinery);		P
	- parts of machinery or workpieces and/or loads held by machinery which are liable to move as a result of potential energy shall be retained for the time necessary to allow them to be safely lowered.		N
6.2.11.6	Use of automatic monitoring		P
	Automatic monitoring is intended to ensure that a safety function(s) implemented by a protective measure do(es) not fail to be performed if the ability of a component or an element to perform its function is diminished, or if the process conditions are changed in such a way that hazards are generated.		P
	Automatic monitoring either detects a fault immediately or carries out periodic checks so that a fault is detected before the next demand upon the safety function.		P
	In either case, the protective measure can be initiated immediately or delayed until a specific event occurs (e.g. the beginning of the machine cycle.) The protective measures may be , e.g.:		P
	- the stopping of the hazardous process;		P
	- preventing the re-start of this process after the first stop following the failure;		
	- the triggering of an alarm		N
6.2.11.7	Safety functions implemented by programmable electronic control systems		P
6.2.11.7.1	General		P
	A control system including programmable electronic equipment (e.g. programmable controllers) can be used to implement safety functions t machinery.		P

EN ISO 12100:2010			
Clause	Requirement-Test	Result-Remark	Verdict
	Where a programmable electronic control system is used it is necessary to consider its performance requirements in relation to the requirements for the safety functions.		P
	The design of the programmable electronic control system shall be such that the probability of random hardware failures and the likelihood of systematic failures that can adversely affect the performance of the safety-related control function(s) are sufficiently low.	Comply with the requirement	P
	Where a programmable electronic control system performs a monitoring function, the system behaviour on detection of a fault shall be considered (see also IEC 61508 series for further guidance)		P
	The programmable electronic control system should be installed and validated to ensure that the specified performance (e.g. safety integrity level (SIL) in IEC 61508 series) for each safety function has been achieved.	Comply with the requirement	P
	Validation comprises testing an analysis (e.g. static, dynamic or failure analysis) to show that all parts interact correctly to perform the safety function and that unintended functions do not occur.		P
6.2.11.7.2	Hardware aspects		P
	The hardware (including e.g. sensors, actuators, logic solvers) shall be selected (and/or designed) and installed to meet both the functional and performance requirements of the safety function(s) to be performed, in particular, by means of :	Logic solvers	P
	- architectural constraints (e.g. the configuration of the system, its ability to tolerate faults, its behaviour on detection of a fault);		P
	- selecting (and/or designing) equipment and devices with an appropriate probability of dangerous random hardware failure;		P
	-Incorporating measures and techniques within the hardware to avoid systematic failures and control systematic faults.		P
6.2.11.7.3	Software aspects		P
	The software (including internal operating software (or system software) and application software) shall be designed so as to satisfy the performance specification for the safety functions (see also IEC 61508-3)	Satisfy the performance specification for the safety functions	P
	Application software		-
	Application software should not be re-programmable by the user.		P
	This may be achieved by use of embedded software in a		N

EN ISO 12100:2010			
Clause	Requirement-Test	Result-Remark	Verdict
	non re-programmable memory (e.g. micro-controller, application specific integrated circuit (ASIC))		
	When the application requires reprogramming by the user, the access o the software dealing with safety functions should be restricted e.g. by : - locks; - passwords for the authorized persons		N
6.2.11.8	Principles relating to manual control		P
	a) Manual control devices shall be designed and located according to the relevant ergonomic principles given in 6.2.8	See the photo.	P
	b) A stop control device shall be placed near each start control device. Where the start/stop function is performed by means of a hold-to-run control, a separate stop control device shall be provided when a risk can result from the hold-to-run control device failing to deliver a stop command when released.	A stop control device has been placed near each start control device.	P
	c) Manual controls shall be located out of reach of the danger zones (see IEC 61310-3), except for certain controls where, of necessity, they are located within a danger zone, such as emergency stop or teach pendant.	Manual controls have been located out of reach of the danger zones.	P
	d) Whenever possible, control devices and control positions shall be located so that the operator is able to observe the working area or hazard zone.	The operator is able to observe the working area or hazard zone.	P
	The driver of a ride-on mobile machine shall be able to actuate all control devices required to operate the machine from the driving position, except for functions which can be controlled more safely from other positions.	Not a ride-on mobile machine	N
	On machinery intended for lifting persons, controls for lifting and lowering and, if appropriate, for moving the carrier, shall generally be located in the carrier. If safe operation requires controls to be situated outside the carrier, the operator in the carrier shall be provided with the means of preventing hazardous movements.	Not for lifting persons.	N
	e) if it is possible to start the same hazardous element by means of several controls, the control circuit shall be so arranged that only one control is effective at a given time. This applies especially to machines which can be manually controlled by means among others of a portable control unit (teach pendant, for instance), with which the operator may enter danger zones.	Only one control.	N
	f) Control actuators shall be designed or guarded so that their effect, where a risk is involved, cannot occur without intentional operation (see ISO 9355-1 and ISO 447)		P

EN ISO 12100:2010			
Clause	Requirement-Test	Result-Remark	Verdict
	g) For machine functions whose safe operation depends on permanent, direct control by the operator, measures shall be taken to ensure the presence of the operator at the control position , e.g. by the design and location of control devices.		N
	h) For cableless control an automatic stop shall be performed when correct control signals are not received, including loss of communication (see EN 60204-1)		P
6.2.11.9	Control mode for setting, teaching, process changeover, fault-finding, cleaning or maintenance		P
	Where, for setting, teaching, process changeover, fault-finding, cleaning or maintenance of machinery, a guard has to be displaced or removed and/or a protective device has to be disabled, and where it is necessary for the purpose of these operations for the machinery or part of the machinery to be put in operation, safety of the operator shall be achieved using a specific control mode which simultaneously:		N
	- disables all other control modes;		N
	- permits operation of the hazardous elements only by continuous actuation of an enabling device, a hold-to-run control device or a two-hand control device;		N
	- permits operation of the hazardous elements only in reduced risk conditions (e.g. reduced speed, reduced power/force, step-by-step operation, e.g. with a limited movement control device)		N
	prevents any operation of hazardous functions by voluntary or involuntary action on the machine's sensors.		N
	This control mode shall be associated with one or more of following measures:		-
	- restriction of access to the danger zone as far as possible.		P
	- emergency stop control within immediate reach of the operator;		P
	- portable control unit (teach pendant) and/or local controls allowing sight of the controlled elements.(see EN 60204-1:2006, 9.2.4)		P
6.2.11.10	Selection of control and operating modes		P
	If machinery has been designed and built to allow for its use in several control or operating modes requiring different protective measures and/or work procedures (e.g. to allow for adjustment , setting, maintenance, inspection), it shall be fitted with a mode selector which can be locked in each position.	Fitted with a mode selector which can be locked in each position.	P
	Each position of the selector shall be clearly identifiable and shall exclusively allow one control or operating mode.		P

EN ISO 12100:2010			
Clause	Requirement-Test	Result-Remark	Verdict
	The selector may be replaced by another selection means which restricts the use of certain functions of the machinery to certain categories of operators (e.g. access codes for certain numerically controlled functions).		P
6.2.11.11	Applying measures achieve electromagnetic compatibility (EMC)		P
	For guidance on electromagnetic compatibility, see EN 60204-1, and IEC 61000-6 series.	EN 61000-6 series	P
6.2.11.12	Provision of diagnostic systems to aid fault-finding		P
	Diagnostic systems to aid fault finding should be included in the control system so that there is no need to disable any protective measures.		P
6.2.12	Minimizing the probability of failure of safety functions		P
6.2.12.1	General		P
	Safety of machinery is not only dependent on the reliability of the control systems but also on the reliability of all parts of the machine. The continued operation of the safety functions is essential for the safe use of the machine. This can be achieved by :		P
6.2.12.2	Use of reliable components		P
	“Reliable components” means components which are capable of withstanding all disturbances and stresses associated with the usage of the equipment in the conditions of intended use (including the environmental conditions), for the period of time or the number of operations fixed for the use, with a low probability of failures generating a hazardous malfunctioning of the machine. Components shall be selected taking into account all factors mentioned above (see also 6.2.13)	Reliable components have been used.	P
6.2.12.3	Use of “oriented failure mode” components		P
	“Oriented failure mode” components or systems are those in which the predominant failure mode is known in advance and which can be used so that such a failure leads to a non-hazardous alteration of the machine function.		P
	The use of such components should always be considered, particularly in cases where redundancy is (see 6.2.12.4) not employed.		P
6.2.12.4	Duplication (or redundancy) of components or subsystems		-
	In the design of safety-related parts of the machine, duplication (or redundancy) of components may be used so that, if one component fails, another component (or other components) continue(s) to perform its (their) function, thereby ensuring that the safety function remains available.	No duplication (or redundancy) of components	N

EN ISO 12100:2010			
Clause	Requirement-Test	Result-Remark	Verdict
	In order to allow the proper action to be initiated, component failure shall be preferably detected by automatic monitoring (see 6.2.11.6) or in some circumstances by regular inspection,	Be preferably detected by automatic monitoring	P
	provided that the inspection interval is shorter than the expected lifetime of the components.		P
	Diversity of design and/or technology can be used to avoid common cause failures (e.g. from electromagnetic disturbance) or common mode failures.		P
6.2.13	Limiting exposure to hazards through reliability of equipment		
	Increased reliability of all component parts of machinery reduces the frequency of incidents requiring rectification, thereby reducing exposure to hazards.	This requirement is complied with.	P
	This applies to power systems (operative part) as well as to control systems, to safety functions as well as to other functions of machinery.	This requirement is complied with.	P
	Safety-critical components (as e.g. certain sensors) with a known reliability shall be used.	Safety-critical components are used .	P
	The elements of guards and of protective services shall be particularly reliable, as their failure can expose persons to hazards, and also as poor reliability would encourage attempts to defeat them.		P
6.2.14	Limiting exposure to hazards through mechanization or automation of loading(feeding) /unloading (removal) operations		P
	Mechanization and automation of machine loading/unloading operations and more generally of handling operations (of workpieces, materials, substances) limit the risk generated by these operations by reducing the exposure of persons to hazards at the operating points.		P
	Automation can be achieved e.g. by robots, handling devices, transfer mechanisms, air blast equipment.		N
	Mechanization can be achieved, e.g. by feeding slides, push rods, hand-operated indexing tables.		N
	While automatic feeding and removal devices have much to offer in preventing accidents to machine operators, they can create danger when any faults are being rectified.		N
	Care shall be taken to ensure that the use of these devices does not introduce further hazards (e.g. trapping, crushing) between the devices and parts of the machine or workpieces/materials being processed.		N
	Suitable safeguards (see 6.3) shall be provided if this cannot be ensured.		N
	Automatic feeding and removal devices with their own	Comply with the	P

EN ISO 12100:2010			
Clause	Requirement-Test	Result-Remark	Verdict
	control systems and the control systems of the associated machine shall be interconnected after thoroughly studying how all safety functions are performed in all control and operation modes of the whole equipment.	requirement	
6.2.15	Limiting exposure to hazards through location of the setting and maintenance points outside of danger zones.		N
	The need for access to danger zones shall be minimized by locating maintenance, lubrication and setting points outside these zones.		N
6.3	Safeguarding and complementary protective measures		P
6.3.1	General		P
	Guards and protective devices shall be used to protect persons whenever inherently safe design does not reasonably make it possible either to remove hazards or to sufficiently reduce risks. Complementary protective measures involving additional equipment (e.g. emergency stop equipment) may have to be implemented.	Appropriate guards and protective devices have been used to protect persons	P
	Certain safeguards may be used to avoid exposure to more than one hazard (e.g. a fixed guard preventing access to a zone where a mechanical hazard is present being used to reduce noise level and collect toxic emissions)	fixed guard is used.	P
6.3.2	Selection and implementation of guards and protective devices		P
6.3.2.1	General	-	
	This subclause gives guidelines for the selection and the implementation of guards and protective devices the primary purpose of which is to protect persons against hazard generated by moving parts, according to the nature of those parts (see figure 4) and to the need for access to the danger zone(s).	Please see the related clause.	P
	The exact choice of a safeguard for a particular machine shall be made on the basis of the risk assessment for that machine.		P
	In selecting an appropriate safeguard for a particular type of machinery or hazard zone, it shall be borne in mind that a fixed guard is simple and shall be used where access of an operator to the danger zone is not required during normal operation (operation without any malfunction) of the machinery.		P
	As the need for frequency of access increase this inevitably leads to the fixed guard not being replaced.		P
	This requires the use of an alternative protective measure (movable interlocking guard, sensitive protective equipment.)		P
	A combination of safeguards may sometimes be		P

EN ISO 12100:2010			
Clause	Requirement-Test	Result-Remark	Verdict
	required. For example , where, in conjunction with a fixed guard, a mechanical loading (feeding) device is used to feed a workpiece into a machine, thereby removing the need for access to the primary hazard zone, a trip device may be required to protect against the secondary drawing-in or shearing hazard between the mechanical loading (feeding) device, when reachable, and the fixed guard.		
	Consideration shall be given to the enclosure of control positions or intervention zones to provide combined protection against several hazards which may include:	This requirement has been taken into consideration.	P
	- hazards from falling or ejected objects (e.g. falling object protection structure)		P
	- emission hazards (e.g. protection against noise, vibration, radiation , harmful substances)		P
	- hazards due to the environment (e.g. protection against heat, cold, foul weather)		P
	- hazards due to tipping over or rolling over of machinery (e.g. roll-over or tip-over protection structure)	No such hazards exist in this machine.	N
	The design of such enclosed work stations (e.g. cabs and cabins) shall take into account ergonomic principles concerning visibility, lighting, atmospheric conditions, access, posture.	No enclosed work stations.	N
6.3.2.2	Where access to the hazard zone is not required during normal operation		P
	Where access to the hazard zone is not required during normal operation of the machinery, safeguard should be selected from the following:		-
	a) fixed guard (see also ISO 14120)	Fixed guards are provided.	P
	b) interlocking guard with or without guard locking (see also 6.3.3.2.3, ISO 14119, ISO 14120);		N
	c) self-closing guard (see ISO 14120:2002, 3.3.2)		P
	d) sensitive protective equipment, e.g. electro-sensitive protective equipment (see IEC 61496) or pressure sensitive mat (see ISO 13856)	No sensitive protective equipment	N
6.3.2.3	Where access to the hazard zone is required during normal operation		P
	Where access to the hazard zone is required during normal operation of the machinery , safeguards should be selected from the following:		-
	a) interlocking guard with or without guard locking (see also ISO 14119, ISO 14120 and 6.3.3.2.3 of this standard);		N
	b) sensitive protective equipment, e.g electro-sensitive protective equipment (see IEC 61496)	No sensitive protective equipment	N
	c) adjustable guard;		N

EN ISO 12100:2010			
Clause	Requirement-Test	Result-Remark	Verdict
	d) self-closing guard (see ISO 14120:2002, 3.3.2)		N
	e) two-hand control device (see ISO 13851)		N
	f) interlocking guard with a start function (control guard) (see 6.3.3.2.5 of this standard)		N
6.3.2.4	Where access to the hazard zone is required for machine setting, teaching, process changeover, fault finding, cleaning or maintenance.		P
	As far as possible, machines shall be designed so that the safeguards provided for the protection of the production operator may ensure also the protection of personnel in charge of setting, teaching, process changeover, fault finding, cleaning or maintenance without hindering them in performing their task.		P
	Such tasks shall be identified and considered in the risk assessment as parts of the use of the machine (see 5.2)		P
6.3.2.5	Selection and implementation of sensitive protective equipment	No sensitive protective equipment	N
6.3.2.5.1	Selection		N
	Due to the great diversity of the technologies on which their detection function is based, all types of sensitive protective equipment are far from being equally suitable for safety applications.		N
	The following provisions are intended to provide the designer with criteria for selecting , for each application , the most suitable device(s).		N
	Types of sensitive protective equipment include, e.g.:		-
	- light curtains;		N
	- scanning devices as, e.g. laser scanners;		N
	- pressure sensitive mats;		N
	- trip bars, trip wires.		N
	Sensitive protective equipment can be used:		-
	- for tripping purposes;		N
	- for presence sensing;		N
	- for both tripping and presence sensing		N
	- to re-initiate machine operation, a practice which is subject to stringent conditions.		N
	The following characteristics of the machinery, among others, can preclude the sole use of sensitive protective equipment:		N
	- tendency for the machinery to eject materials or component parts;		N
	- necessity to guard against emissions (noise, radiation, dust, etc.)		N
	- erratic or excessive machine stopping time;		N
	- inability of a machine to stop part-way through a cycle.		N

EN ISO 12100:2010			
Clause	Requirement-Test	Result-Remark	Verdict
6.3.2.5.2	Implementation		N
	consideration should be given to :		-
	a) - size, characteristics and positioning of the detection zone (see ISO 13855, which deals with the positioning of some types of sensitive protective equipment)		N
	b) - reaction of the device to fault conditions (see IEC 61496 for electro-sensitive protective equipment)		N
	c)- possibility of circumvention		N
	d)- detection capability and its variation over the course of time (e.g. as a result of its susceptibility to different environmental conditions such as the presence of reflecting surfaces, other artificial light sources, sunlight or impurities in the air.		N
	sensitive protective equipment shall be integrated in the operative part and associated with the control system of the machine so that:		N
	- a command is given as soon as a person or part of a person is detected;		N
	- the withdrawal of the person or part of a person detected does not, by itself, restart the hazardous machine function (s); therefore, the command given by the sensitive protective equipment shall be maintained by the control system until a new command is given;		N
	- restarting the hazardous machine function(s) results from the voluntary actuation , by the operator, of a control device placed outside the hazard zone, where this zone can be observed by the operator;		N
	- the machine cannot operate during interruption of the detection function of the sensitive protective equipment, except during muting phases,;		N
	- the position and the shape of detection field prevents, ,possibly together with fixed guards, a person or part of a person from entering the hazard zone, or being present in it, without being detected.		N
6.3.2.5.3	Additional requirements for sensitive protective equipment when used for cycle initiation.		N
	In this exceptional application, starting of the machine cycle is initiated by the withdrawal of a person or of the detected part of a person from the sensing field of the sensitive protective equipment, without any additional start command, hence deviating from the general requirement given in the second point of the dashed list in 6.3.2.5.2, above. After switching on the power supply, or when the machine has been stopped by the tripping function of the sensitive protective equipment, the machine cycle shall be initiated only by voluntary		N

EN ISO 12100:2010			
Clause	Requirement-Test	Result-Remark	Verdict
	actuation of a start control.		
	Cycle initiation by sensitive protective equipment shall be subject to the following conditions:		-
	a) only active optoelectronic protective devices (AOPDs) complying with IEC 61496 series shall be used;		N
	b) the requirements for an AOPD used as a tripping and presence-sensing device (see IEC 61496) are satisfied — in particular, location, minimum distance (see ISO 13855), detection capability, reliability and monitoring of control and braking systems;		N
	c) the cycle time of the machine is short and the facility to re-initiate the machine upon clearing of the sensing field is limited to a period commensurate with a single normal cycle;		N
	d) entering the sensing field of the AOPD(s) or opening interlocking guards is the only way to enter the hazard zone;		N
	e) if there is more than one AOPD safeguarding the machine, only one of the AOPD (s) is capable of cycle re-initiation;		N
	f) with regard to the higher risk resulting from automatic cycle initiation, the AOPD and the associated control system comply with a higher safety-related performance than under normal conditions.		N
6.3.2.6	Protective measures for stability		P
	If stability cannot be achieved by inherently safe design measures such as weight distribution (see 4.6), it will be necessary to maintain it by protective measures such as the use of :		P
	- anchorage bolts;		P
	- locking devices;		P
	- movement limiters or mechanical stops;		N
	- acceleration or deceleration limiters;		N
	- load limiters;		N
	- alarms warning of the approach to stability or tipping limits;		N
6.3.2.7	Other protective devices		N
	When a machine requires continuous control by the operator(e.g. mobile machines, cranes) and an error of the operator can generate a hazardous situation, this machine shall be equipped with the necessary devices to enable the operation to remain within specified limits , in particular:		N
	- when the operator has insufficient visibility of the hazard zone;		N

EN ISO 12100:2010			
Clause	Requirement-Test	Result-Remark	Verdict
	- when the operator lacks knowledge of the actual value of a safety –related parameter (e.g. .a distance, a speed, the mass of a load, the angle of a slope)		N
	- when hazards may result from operations other than those controlled by the operator;		N
	The necessary devices include:		-
	- devices for limiting parameters of movement (distance, angle, velocity , acceleration)		N
	- overloading and moment limiting devices:		N
	- devices to prevent collisions or interference with other machines;		N
	-device for preventing hazards to pedestrian operators of mobile machinery or other pedestrians;		N
	- torque limiting devices, breakage points to prevent excessive stress of components and assemblies;		N
	- devices for limiting pressure, temperature;		N
	- devices for monitoring emissions;		N
	- devices prevent operation in the absence of the operator at the control position;		N
	- device to prevent lifting operations unless stabilizers are in place;		N
	- devices to limit inclination of the machine on a slope;		N
	- devices to ensure that components are in a safe position before traveling;		N
	Automatic protective measures triggered by such devices which take operation of the machinery out of the control of the operator (e.g. automatic stop of hazardous movement) should be preceded or accompanied by a warning signal to enable the operator to take appropriate action (see 6.4.3)		N
6.3.3	Requirements for the design of guards and protective devices		P
6.3.3.1	General requirements		P
	Guards and protective devices shall be designed to be suitable for the intended use, taking into account mechanical and other hazards involved. Guards and protective devices shall be compatible with the working environment of the machine and designed so that they cannot be easily defeated. They shall provide the minimum possible interference with activities during operation and other phases of machine life, in order to reduce any incentive to defeat them.	Guards and protective devices have been appropriately designed.	P
	Guards and protective devices shall :		-
	- be of robust construction.	Steel	P
	- not give rise to any additional hazard;	No additional hazard	P

EN ISO 12100:2010			
Clause	Requirement-Test	Result-Remark	Verdict
	- not be easy to by-pass or render non-operational;	not be easy to by-pass	P
	- be located at an adequate distance from the danger zone (see ISO 13857 and ISO 13855).	an adequate distance from the danger zone	P
	- cause minimum obstruction to the view of the production process;		P
	- enable essential work to be carried out on installation and/or replacement of tools and also for maintenance by allowing access only to the area where the work has to be done, if possible without the guard or protective device having to be moved;		P
	For openings in the guards see ISO 13857		P
6.3.3.2	Requirements for fixed guards		P
6.3.3.2.1	Functions of guards		P
	The functions that guards can achieve are:		P
	- prevention of access to the space enclosed by guard and/or - containment/capture of materials, workpieces, chips, liquids which may be ejected or dropped by the machine and reduction of emissions(noise, radiation, hazardous substances such as dust, fumes, gases) which may be generated by the machine.	The space enclosed. Containment of workpieces, chips, liquids which may be ejected by the machine	P
	Additionally, they may need to have particular properties relating to electricity, temperature, fire, explosion, vibration, visibility(see ISO 14120) and operator position ergonomics(e.g. usability, operator's movements, posture, repetitive movements).		P
6.3.3.2.2	Requirements for fixed guards		P
	Fixed guards shall be securely held in place:		-
	- either permanently (e.g. by welding) - or by means of fasteners (screws, nuts) making removal/opening impossible without using tools; they should not remain closed without their fasteners (see ISO 14120)	All the fixed guards are securely held in place by appropriate fasteners.	P
6.3.3.2.3	Requirements for movable guards		P
	a) movable guards which provide protection against hazards generated by moving transmission parts shall :		-
	- as far as possible remain fixed to the machinery or other structure (generally by means of hinges or guides) when open;	by means of guides or hinges	P
	- be interlocking guards (with guard locking when necessary) (see ISO 14119)		N
	b) movable guards against hazards generated by non-transmission moving parts shall be designed and associated with the machine control system so that:		-
	- moving parts cannot start up while they are within the		N

EN ISO 12100:2010			
Clause	Requirement-Test	Result-Remark	Verdict
	operator's reach and the operator cannot reach moving parts once they have started up ; this can be achieved by interlocking guards, with guard locking when necessary.		
	- they can be adjusted only by an intentional action , such as the use of a tool or a key;		N
	- the absence or failure of one of their components prevents starting of the moving parts or stops them; this can be achieved by automatic monitoring (see 4.11.6)		N
6.3.3.2.4	Requirements for adjustable guards		N
	Adjustable guards may only be used where the hazard zone cannot for operational reasons be completely enclosed;		N
	They shall :		-
	- be designed so that the adjustment remains fixed during a given operation;		N
	- be readily adjustable without the use of tools;		N
6.3.3.2.5	Requirements for interlocking guards with a start function (control guards)		N
	An interlocking guard with a start function may be used provided that		-
	- all requirements for interlocking guards are satisfied (see ISO 14119)		N
	- the cycle time of the machine is short		N
	- the maximum opening time of the guard is present to a low value (e.g. equal to the cycle time). When this time is exceeded, the hazardous function(s) cannot be initiated by the closing of the interlocking guard with a start function and resetting is necessary before restarting the machine.		N
	- the dimensions or shape of the machine do not allow a person, or part of a person, to stay in the hazard zone or between the hazard zone and the guard while the guard is closed (see ISO 14120)		N
	- all other guards whether fixed (removable type) or movable are interlocking guards;		N
	- the interlocking device associated with the interlocking guard with a start function is designed in such a way – e.g. by duplication of position detectors and use of automatic monitoring (see 4.11.6)- that its failure cannot lead to an unintended/unexpected start-up;		N
	- the guard is securely held open (e.g. by a spring or counterweight)such that it cannot initiate a start while falling by its own weight;		N
6.3.3.2.6	Hazards from guards		P
	Care shall be taken to prevent hazards which might be generated by :		-

EN ISO 12100:2010			
Clause	Requirement-Test	Result-Remark	Verdict
	- the guard construction (e.g. sharp edges or corners, material);	No harp edges and corners.	P
	- the movements of the guards (shearing or crushing zones generated by power-operated guards and by heavy guards which are liable to fall)		N
6.3.3.3	Technical characteristics of protective devices		P
	Protective devices shall be selected or designed and connected to the control system so as to ensure correct implementation of their safety function (s) is ensured.		P
	Protective devices shall be selected on the basis of their having met the appropriate product standard (for example, IEC 61496 for active optoelectronic protective devices) or shall be designed according to one or several of the principles formulated in ISO 13849-1 or IEC 62061.		P
	Protective devices shall be installed and connected to the control system so that they cannot be easily defeated.		P
6.3.3.4	Provisions for alternative types of safeguards.		N
	Provisions should be made to facilitate the fitting of alternative types of safeguards on machinery where it is known that this fitting will be necessary because the work to be done on it will vary.		N
6.3.4	Safeguarding for reducing emissions		P
6.3.4.1	General		
	If the measures for the reduction of emissions at source mentioned in 6.2.2.2 are not adequate, the machine shall be provided with additional protective measures (see 6.3.4.2 to 6.3.4.5).		P
6.3.4.2	Noise		P
	Additional protective measures include, for example: - enclosures (see ISO 15667) - screens fitted to the machine; - silencers (see ISO 14163)	Enclosures	P
6.3.4.3	Vibration		N
	Additional protective measures include, for example, damping devices for vibration isolation between the source and the exposed person such as resilient mounting or suspended seats.		N
	For measures for vibration isolation of stationary industrial machinery see EN 1299		N
6.3.4.4	Hazardous substances		P
	Additional protective measures include, for example:		-
	- encapsulation of the machine (enclosure with negative pressure);	Encapsulation of the machine	P
	- local exhaust ventilation with filtration.		N

EN ISO 12100:2010			
Clause	Requirement-Test	Result-Remark	Verdict
	- wetting with liquids;		N
	- special ventilation in the area of the machine (air curtains , cabins for operators)		N
6.3.4.5	Radiation		N
	Additional protective measures include, for example:		-
	- use of filtering and absorption;		N
	- use of attenuating screens or guards		N
6.3.5	Complementary protective measures		P
6.3.5.1	General		P
	Protective measures which are neither inherently safe design measures, nor safeguarding (implementation of guards and/or protective devices), nor information for use may have to be implemented as required by the intended use and the reasonably foreseeable misuse of the machine.Such measures include, but are not limited to , the ones dealt with in 6.3.5.2 to 6.3.5.6		P
6.3.5.2	Components and elements to achieve the emergency stop function		P
	If following a risk assessment, a machine needs to be fitted with components and elements to achieve an emergency stop function to enable actual or impending emergency situations to be averted, the following requirements apply:		-
	- the actuators shall be clearly identifiable, clearly visible and readily accessible		P
	- the hazardous process shall be stopped as quickly as possible without creating additional hazards . If this is not possible or the risk cannot be reduced, it should be questioned whether implementation of an emergency stop function is the best solution;		N
	- the emergency stop control shall trigger or permit the triggering of certain safeguard movements where necessary.		P
	Once active operation of the emergency stop device has ceased following an emergency stop command, the effect of this command shall be sustained until it is reset.		P
	This reset shall be possible only at that location where the emergency stop command has been initiated.The reset of the device shall not restart the machinery , but only permit restarting.		P
	More details for the design and selection of electrical components and elements to achieve the emergency stop function are provided in EN 60204 series.		P
6.3.5.3	Measures for the escape and rescue of trapped persons		P
	Measures for the escape and rescue of trapped persons may consist e.g. of :		-

EN ISO 12100:2010			
Clause	Requirement-Test	Result-Remark	Verdict
	- escape routes and shelters in installations generating operator-trapping hazards		P
	- arrangements for moving some elements by hand, after an emergency stop		N
	- arrangements for reversing the movement of some elements		N
	- anchorage points for descender devices;		N
	- means of communication to enable trapped operators to call for help		P
6.3.5.4	Measures for isolation and energy dissipation		P
	Especially with regard to their maintenance and repair , machines shall be equipped with the technical means to achieve the isolation from power supply(ies) and dissipation of stored energy as a result of following actions:		P
	a) isolating (disconnecting, separating) the machine (or defined parts of the machine) from all power supplies;		P
	b) locking (or otherwise securing) all the isolating units in the isolating position;		P
	c) dissipating or , if this is not possible or practicable, restraining (containing) any stored energy which may give rise to a hazard;		N
	d) verifying, by means of a safe working procedure, that the actions taken according to a), b) and c) above have produced the desired effect.		P
	See ISO 14118:2000, clause 5 and EN 60204-1:2006, 5.5 and 5.6	See the test report of EN 60204-1.	P
6.3.5.5	Provisions for easy and safe handling of machines and their heavy component parts		P
	Machines and their component parts which cannot be moved or transported by hand shall be provided or capable of being provided with suitable attachment devices for transport by means of lifting gear.	Provided with suitable attachment devices for transport by means of lifting gear.	P
	These attachments may be, among others,		-
	- standardized lifting appliances with slings, hooks, eyebolts, or tapped holes for appliance fixing;	slings	P
	- appliances for automatic grabbing with a lifting hook when attachment is not possible from the ground.		N
	- guiding grooves for machines to be transported by a fork truck;		N
	- lifting gear and appliances integrated into the machine.		N
	Parts of machinery which can be removed manually in operation shall be provided with means for their safe removal and replacement; See also 6.4.4c) (item 3).	Not removed manually in operation	N
6.3.5.6	Measures for safe access to machinery		N

EN ISO 12100:2010			
Clause	Requirement-Test	Result-Remark	Verdict
	Machinery shall be so designed as to enable operation and all routine tasks relating to setting and/or maintenance, to be carried out, as far as possible, by a person remaining at ground level.	Comply with requirements	P
	Where this is not possible, machines shall have built-in platforms, stairs or other facilities to provide safe access for those tasks, but care should be taken to ensure that such platforms or stairs do not give access to danger zones of machinery.		N
	The walking areas shall be made from materials which remain as slip resistant as practicable under working conditions and, depending on the height from the ground, suitable guard-rails (see ISO 14122-3) shall be provided.	Comply with requirements	P
	In large automated installations, particular attention shall be given to safe means of access such as walkways, conveyor bridges or crossover points.		N
	Means of access to parts of machinery located at a height shall be provided with collective means of protection against falls (e.g. guard-rails for stairways, stepladders and platforms and/or safety cages for ladders)		N
	As necessary , anchorage points for personal protective equipment against falls from a height shall also be provided (e.g. in carriers of machinery for lifting persons or with elevating control sations)		N
	Openings shall whenever possible open towards a safe position. They shall be designed to prevent hazards due to unintended opening.		N
	The necessary aids for access shall be provided (e.g. steps, handholds). Control devices shall be designed and located to prevent their being used as aids for access.		N
	When machinery for lifting goods and/or persons includes landings at fixed levels, these shall be equipped with interlocking guards preventing falls when the platform is not present at the level.		P
	Movement of the lifting platform shall be prevented while the guards are open.		P
	For detailed provisions see ISO 14122.		N
6.4	Information for use		P
6.4.1	General requirements		P
6.4.1.1	Drafting information for use is an integral part of the design of a machine (see figure 2).		P
	Information of use consists of communication links, such as texts, words, signs, signals, symbols or diagrams, used separately or in combination to convey information to the user. It is directed to professional and/or non-professional users.		P

EN ISO 12100:2010			
Clause	Requirement-Test	Result-Remark	Verdict
6.4.1.2	Information shall be provided to the user about the intended use of the machine, taking into account, notably, all its operating modes.	See the instruction	P
	The information shall contain all directions required to ensure safe and correct use of the machine. With this in view, it shall inform and warn the user about residual risk.	See the instruction	P
	The information shall indicate, as appropriate,		-
	- the need for training,	See the instruction	P
	- the need for personal protective equipment,		P
	- the possible need for additional guards or protective devices (see Figure 2, Footnote d).	See the instruction	P
	It shall not exclude uses of the machine that can reasonably be expected from its designation and description and shall also warn about the risk which would result from using the machine in other ways than the ones described in the information, especially considering its reasonably foreseeable misuse.	See the instruction	P
6.4.1.3	Information for use shall cover, separately or in combination, transport, assembly and installation, commissioning, use of the machine (setting, teaching/programming or process changeover, operation, cleaning, fault-finding and maintenance) and, if necessary, dismantling, disabling and scrapping.	See the instruction	P
6.4.2	Location and nature of the information for use		P
	Depending on the risk , the time when the information is needed by the user and the machine design , it shall be decided whether the information – or parts thereof – are to be given:		P
	- in /on the machine itself (see 6.3 and 6.4.4)	Adequate information is stated in the machine itself.	P
	- in accompanying documents (in particular instruction handbook , see 6.4.5)	See the instruction	P
	- on the packaging	Adequate information is stated on the packaging	P
	- by other means such as signals and warnings outside the machine.	Signals and warnings outside the machine.	P
	Standardized phrases shall be considered where important messages such as warnings need to be given (see also IEC 62079)		P
6.4.3	Signals and warning devices		P
	Visual signals (e.g. flashing lights) and audible signals (e.g. sirens) may be used to warn of an impending hazardous event such as machine start-up or overspeed.	Signals and warning devices are provided.	P

EN ISO 12100:2010			
Clause	Requirement-Test	Result-Remark	Verdict
	Such signals may also be used to warn the operator before the triggering of automatic protective measures (see last paragraph of 5.2.7)	Please the related clause.	P
	It is essential that these signals:		-
	- be emitted before the occurrence of the hazardous event; - be unambiguous; - be clearly perceived and differentiated from all other signals used; - be clearly recognized by the operator and other persons.	Unambiguous, clearly perceived, clearly recognized	P
	The warning devices shall be designed and located such that checking is easy.		N
	The information for use shall prescribe regular checking of warning devices.		P
	The attention of designers is drawn to the risks from “sensorial saturation” which results from too many visual and/or acoustic signals, which may also lead to defeating the warning devices.		P
6.4.4	Markings, signs (pictograms), written warnings		P
	Machinery shall bear all markings which are necessary:		-
	a) for its unambiguous identification, at least :		-
	- name and address of the manufacturer; - designation of series or type; - serial number, if any.		P
	b) in order to indicate its compliance with mandatory requirements; - marking; - written indications (e.g. for machines intended for use in potentially explosive atmosphere)		N
	c) for its safe use, e.g. :		-
	- maximum speed of rotating parts;		N
	- maximum diameter of tools;		N
	- mass (expressed in kilograms) of the machine itself and/or of removable parts		N
	- maximum working load;		N
	-necessity of wearing personal protective equipment;		P
	- guard adjustment data;		P
	- frequency of inspection.	See the instruction	P
	Information printed directly on the machine should be permanent and remain legible throughout the expected life of the machine.	Permanent and remain legible	P
	Signs or written warnings only saying “danger” shall not be used.		P

EN ISO 12100:2010			
Clause	Requirement-Test	Result-Remark	Verdict
	Markings, signs and written warnings shall be readily understandable and unambiguous, especially as regards the part of the function(s) of the machine which they are related to.		P
	Readily understandable signs (pictograms) should be used in preference to written warnings.		P
	Signs and pictograms should only be used if they are understood in the culture in which the machinery is to be used.		P
	Markings shall comply with recognized standards (see ISO 2972, ISO 7000, particularly for pictograms, symbols , colours) See EN 60204 series as regards marking of electrical equipment.	All the markings are standard.	P
6.4.5	Accompanying documents (in particular, instruction handbook)		P
6.4.5.1	Contents		P
	The instruction handbook or other written instructions (e.g. on the packaging) shall contain among others:		-
	a) information relating to transport, handling and storage of the machine e.g. : - storage conditions for the machine; - dimensions , mass value(s), position of the centre (s) of gravity; - indications for handling (e.g. drawings indicating application points for lifting equipment)	All the related information is stated in the instruction handbook	P
	b) information relating to installation and commissioning of the machine, e.g. - fixing/anchoring and vibration dampening requirements; - assembly and mounting conditions; - space needed for use and maintenance; - permissible environmental conditions (e.g. temperature, moisture, vibration, electromagnetic radiation); - instructions for connecting the machine to power supply (particularly about protection against electrical overloading); - advice about waste removal /disposal; - if necessary, recommendations about protective measures which have to be taken by the user; e.g. additional safeguards, safety distances, safety signs and signals.	All the related information is stated in the instruction handbook	P

EN ISO 12100:2010			
Clause	Requirement-Test	Result-Remark	Verdict
	<p>c) information relating to the machine itself, e.g. :</p> <ul style="list-style-type: none"> - detailed description of the machine, its fittings, its guards and/or protective devices; - comprehensive range of applications for which the machine is intended, including prohibited usages, if any , taking into account variations of the original machine if appropriate. - diagrams ; - data about noise and vibration generated by the machine, about radiation , gases, vapours, dust emitted by it, with reference to the measuring methods used. - technical documentation about electrical equipment - documents attesting that the machine complies with mandatory requirements; 	All the related information is stated in the instruction handbook	P
	<p>d) information relating to the use of the machine, e.g. about:</p> <ul style="list-style-type: none"> - intended use; - description of manual controls (actuators); - setting and adjustment; - modes and means for stopping - risks which could not be eliminated by the protective measures taken by the designer; - particular risks which may be generated by certain applications, by the use of certain fittings, and about specific safeguards which are necessary for such applications. - reasonably foreseeable misuse and prohibited usages; - fault identification and location , repair, and re-starting after an intervention; - personal protective equipment which need to be used and training required. 	All the related information is stated in the instruction handbook	P
	<p>e) information for maintenance e.g.</p> <ul style="list-style-type: none"> - nature and frequency of inspections for safety functions; - instructions relating to maintenance operations which require a definite technical knowledge or particular skills and hence should be carried out exclusively by skilled persons (e.g. maintenance staff, specialists) - instructions relating to maintenance actions (e.g. replacement of parts) which do not require specific skills and hence may be carried out by users (e.g. operators) - drawings and diagrams enabling maintenance personnel to carry out their task rationally 	All the related information is stated in the instruction handbook	P
	<p>f) information relating to de-commissioning , dismantling and disposal;</p>	See the instruction handbook	P



EN ISO 12100:2010			
Clause	Requirement-Test	Result-Remark	Verdict
	g) information for emergency situations , e.g. : - type of fire-fighting equipment to be used. - warning about possible emission or leakage of harmful substance(s), and if possible, indication of means to fight their effects.		N
	h) maintenance instructions provided for skilled persons (second dash in e))and maintenance instructions provided for unskilled persons (third dash in e)), that should appear clearly separated from each other.	All the related information is stated in the instruction handbook	P
6.4.5.2	Production of the instruction handbook		P
	a) type and size of print shall ensure the best possible legibility. Safety warnings and/or cautions should be emphasized the use of colours, symbols and/or large print.	Legibility.	P
	b) information for use shall be given in the language(s) of the country in which the machine will be used for the first time and in the original version. If more than one language are to be used, each language should be readily distinguished from the other(s), and efforts should be made to keep the translated text and the relevant illustration together.	English	P
	c) whenever helpful to the understanding, text should be supplemented with written details enabling , for instance, manual controls (actuators) to be located and identified; they should not be separated from the accompanying text and should follow sequential operations.	See the Instruction handbook.	P
	d) consideration should be given to presenting information in tabular form where this will aid understanding. Tables should be adjacent to the relevant text.	See the Instruction handbook.	P
	e) the use of colours should be considered, particularly in relation to components requiring quick identification.		N
	f) when information for use is lengthy, a table of contents and/or an index should be given.		P
	g) safety-relevant instructions which involve immediate action should be provided in a form readily available to the operator.		P
6.4.5.3	Drafting and editing information for use		P
	a) relationship to model : the information shall clearly relate to the specific model of machine and, if necessary, other appropriate identification (for example, by serial number).	See the difference between the models	P
	b) communicate principles : when information for use is being prepared, the communication process “see-think-use” should be followed in order to achieve the maximum effect and should follow sequential		P

EN ISO 12100:2010			
Clause	Requirement-Test	Result-Remark	Verdict
	operations. The questions “how ?” and “why ?” should be anticipated and the answers provided.		
	c) information for use shall be as simple and as brief as possible, and should be expressed in consistent terms and units with a clear explanation of unusual technical terms.		P
	d) when it is foreseen that a machine will be put to non-professional use, the instructions should be written in a form that is readily understood by the non-professional users. If personal protective equipment is required for the safe use of the machine, clear advice should be given, e.g. on the packaging as well as on the machine, so that this information is prominently displayed at the point of sale.	Not for non-professional use	N
	e) durability and availability of the documents : documents giving instructions for use should be produced in durable form (i.e. they should be able to survive frequent handling by the user). It may be useful to mark them “keep for future reference”. Where information for use is kept in electronic form (e.g. CD, DVD, tape) information on safety-related issues that need immediate action shall always be backed up with a hand copy that is readily available.	Kept in electronic form	P
7	Documentation of risk assessment and risk reduction		P
	The documentation shall demonstrate the procedure that has been followed and the results that have been achieved. This includes, when relevant, documentation of		-
	a) the machinery for which the risk assessment has been made (for example, specifications, limits, intended use);		P
	b) any relevant assumptions that have been made (loads, strengths, safety factors, etc.);		P
	c) the hazards and hazardous situations identified and the hazardous events considered in the risk assessment;		P
	d) the information on which risk assessment was based (see 5.2):		-
	1) the data used and the sources (accident histories, experience gained from risk reduction applied to similar machinery, etc.);		P
	2) the uncertainty associated with the data used and its impact on the risk assessment;		P
	e) the risk reduction objectives to be achieved by protective measures;		P
	f) the protective measures implemented to eliminate identified hazards or to reduce risk;	Warning sign and wear PPE	P
	g) residual risks associated with the machinery;		P

EN ISO 12100:2010			
Clause	Requirement-Test	Result-Remark	Verdict
	h) the result of the risk assessment (see Figure 1);	See the risk assessment report.	P
	i) any forms completed during the risk assessment.		P
	Standards or other specifications used to select protective measures referred to in f) above should be referenced.		P

EN 60204-1:2018			
Clause	Requirement-Test	Result-Remark	Verdict
1	Scope		
	This part of EN 60204 applies to the application of electrical and electronic equipment and systems to machines not portable by hand while working. Including a group of machines working higher level system aspects	This machine is within this scope.	P
	This part is applicable to the electrical equipment or parts of the electrical equipment that operate with nominal supply voltages not exceeding 1000V for alternating current and not exceeding 1500V for direct current, and with nominal frequencies not exceeding 200Hz		P
2	Normative references		
3	Definitions		
4	General requirements		
4.1	The risks associated with the hazards relevant to the electrical equipment shall be assess as part of the overall requirements for risk assessment of the machine	See the risk assessment report in detail.	P
4.2	Selection of equipment		P
	Electrical components and devices shall be suitable for their intended use and shall conform to relevant IEC standards where such exist	Suitable for their intended use	P
4.3	Electrical supply		P
4.3.1	Electrical equipment to be designed for correct operation with conditions of mains power supply	See below	P
4.3.2	Supply Voltage:		P
	Frequency:	50/60Hz	P
	Harmonics:	<5% of the total r.m.s voltage	P
	Voltage unbalance:	<5% positive sequence	P
	Voltage interruption:	Comply with requirement	P
	Voltage dips:	Comply with requirement	P
4.3.3	DC Supplies Voltage:		N
	Voltage interruption		N
	Ripple (peak-peak):		N
4.3.4	Onboard power supply acc. to cl. 4.3.2 and 4.3.3	Not onboard power supply	N
4.4	Physical environment and operating conditions	See instruction	P
4.4.1	Electrical equipment to be suitable for use in physical environment and operating conditions		P
4.4.2	Electromagnetic compatibility (EMC)		P

EN 60204-1:2018			
Clause	Requirement-Test	Result-Remark	Verdict
	Equipment not to generate electromagnetic disturbances above harmful levels: (applicable EMC-standard: EN 50081-2)	EN 61000-6-1	P
	Equipment has adequate level of immunity to EMC: (applicable EMC-standards: EN 50082-2)	EN 61000-6-3	P
4.4.3	Electrical equipment to be capable for correct operation at intended ambient air temperature		P
4.4.4	Electrical equipment to be capable for correct operation at specified relative humidity:		P
4.4.5	Electrical equipment capable of operating correctly at altitudes up to 1000 m above m.s.l.		P
4.4.6	Electrical equipment shall be adequately protected against ingress of solid properties and liquids		P
4.4.7	Ionizing and non-ionizing radiation Electrical equipment subject to radiation, additional measures to be taken to avoid equipment malfunction	The electrical equipment of the machine is not subject to ionizing and non-ionizing radiation.	N
4.4.8	Undesirable effects of vibration, shock and bump avoided	The machine equips with cushion reduced vibration	P
4.5	Transportation and storage		P
	-2.5. C to + 55. C And short periods not exceeding 24 h at up to + 70. C	Comply with the requirements	P
4.6	Provisions for handling		P
	Heavy and bulky equipment shall be moved by cranes or similar equipment	Appropriate equipments are provided.	P
4.7	Installation and operation		P
	According to supplier's instructions	All the related information is stated in the instruction manual.	P
5	Incoming supply conductors terminations and devices for disconnecting and switching off		P
5.1	Incoming supply conductor terminations		P
	Single or multiple power supply	Single power supply.	P
	The supply conductors are terminated at the supply disconnection device if not, the separate terminals shall be provided	Mains Switch used	P
	If a neutral conductor is used, it shall be indicated clearly in the technical documentation	Labelled by Letter N	P
	No connection between the protective bonding circuit and the neutral conductor	No connection	P
	All terminals for the incoming supply connection shall be identified clearly	All terminals marked correct label	P
5.2	Terminal for connection to the external protective earthing system		P

EN 60204-1:2018			
Clause	Requirement-Test	Result-Remark	Verdict
	Shall be in the vicinity of the associated phase conductor terminals		P
	Cross-sectional area of the external protective copper conductor according to table 1		P
	Marking of the external protective conductor with the letters "PE"	'PE' is marked.	P
	Other protective terminals shall be marked with the symbol 		P
	All protective terminals shall be coloured by use of the bicolor combination Green-And-Yellow	Green-And-Yellow	P
5.3	Supply disconnecting (isolating) device		P
5.3.1	General		-
	Shall disconnect (isolate) the electrical equipment of the machine from supply when required	Mains switch and used circuit breaker	P
	If two or more supply disconnecting devices are provided, protective interlocks shall be used		P
5.3.2	Type		-
	a) Switch-disconnector according to en60947-3 b) A disconnector with auxiliary contact c) Circuit breaker according to EN 60947-2 d) any other switching device in accordance with an IEC product standard e) a plug/socket combination for a flexible cable supply.		P
5.3.3	Requirements		P
	Have one OFF and one ON position only	On and off position	P
	Marked clearly with "I" and "O"	marked with "O" and "I"	P
	Have a reset(tripped) position between "O" and "I"		N
	Have an external operating means		P
	The handle should be Black or Grey		N
	Could be locked in the OFF position		P
	Disconnect all live conductors of its power supply circuit		P
	Sufficient breaking capacity		P
5.3.4	Operating handle		-
	Shall be easily accessible and located:0.6 m~1.9 m		P
5.3.5	Excepted circuits		-
	Following circuits not disconnect by supply disconnecting device:		-
	Lighting circuits during maintenance or repair		P
	Plug/socket outlets exclusively used for maintenance or repair	No plug/socket outlets	N
	Undervoltage protection circuits used for automatic tripping only at power supply failures	No undervoltage protection circuits	N

EN 60204-1:2018			
Clause	Requirement-Test	Result-Remark	Verdict
	Circuits of equipment to remain normally energised for satisfactory operation		N
	Control circuits for interlocking purposes		P
	Circuits which are not disconnected by supply disconnecting device:		-
	Permanent warning labels placed in proximity of supply disconnectors		N
	Appropriate remark in maintenance manual		N
	Warning label in proximity of circuit concerned		N
	or wiring separated from other wiring		N
	Wiring of safety interlocking circuits installed with different colour of insulation.		N
5.4	Devices for switching off for prevention of unexpected start-up		P
	Means shall be provided to prevent inadvertent and / or mistaken closure of the disconnecting device	Stop button applied	P
	Such devices appropriate and convenient for intended use		P
	Suitable placed		P
	Readily identifiable	marking used	P
	Disconnecting devices acc. to cl. 5.3.2 used:		P
	Other disconnecting devices for the following situations only:		-
	- no significant dismantling of the machine		N
	- adjustments requiring a relatively short time		N
	No work at the electrical equipment of the machine except:		-
	- no hazard arising of electric shock or burn		N
	- switched-off status cannot be released due to maintenance work		N
	- work of minor nature		N
5.5	Devices provided for disconnecting electrical equipment		P
	Supply-disconnecting device used	Circuit breaker used	P
	Disconnecting device provided for each separated part of the machine or partial machine where necessary	Circuit breaker used for each branch circuits	P
	Disconnectors, fuse links etc. used only in enclosed electrical operating areas	Used in operation areas	P
	Such disconnecting devices appropriate and	appropriate and	P

EN 60204-1:2018			
Clause	Requirement-Test	Result-Remark	Verdict
	convenient for intended use and	convenient for intended use	
	Suitably located and	Location suitable	P
	readily identifiable to which part it serves and	Marking used	P
5.6	Provided with adequate means to prevent unauthorised, inadvertent and /or mistaken closing	Identification applied	P
	Devices acc. to cl. 5.4 and 5.5 provided with locking means	Circuit breaker is inside the metal enclosure which is opened using key by skilled person	P
	Other means of protection against unintended energising used for non-lockable disconnecting devices (for electrical operating areas only)	Warning message used.	P
	Locking device not necessary for plug/ socket outlet combinations, if located in a suitable manner and under immediate supervision of the person carrying out the work	No plug/ socket outlet combinations.	N
6	Protection against electric shock		P
6.1	General	See the relevant clauses.	P
6.2	Protection against direct contact		P
6.2.1	General		-
	Either 6.2.2 or 6.2.3 and, where applicable, 6.2.4 shall be applied	See the relevant clauses.	P
	When the equipment is located in places open to all persons, measures of either 6.2.3 or 6.2.2 with a min. degree of protection against direct contact corresponding to IP4X or IPXXD shall be applied	This machine shall be located in the factory, and be operated by the authorized persons.	N
6.2.2	Protection by enclosures		P
	Min protection degree for live parts: IP2X or IPXXB		P
	Min. protection degree for top surface:IP4X or IPXXD		P
	Opening an enclosure shall only be possible under one of the following conditions:		-
a)	The use of a key or tool is necessary by skilled or instructed persons	Open the enclosure by using a key	P
	Min. protection degree for live parts on the inside of doors:IP1X or IPXXA		P
	live parts likely to be touched during resetting or adjustment with protection degree IP2X or IPXXB		P
b)	The disconnection of live parts inside the enclosure before the enclosure may be opened (Use of the supply disconnecting device)		N
	at door interlocking safety circuit, door will open		N

EN 60204-1:2018			
Clause	Requirement-Test	Result-Remark	Verdict
	only when main isolator is in open position		
	For skilled persons a special device provided, to defeat interlocking circuit under following conditions:		
	Special device or tool provided to permit skilled persons to defeat the interlock provided that:		
	- opening of disconnecter possible at all times while interlock is defeated		N
	- upon closing the door, interlock is automatically restored		N
	If more than one door allows access to live parts, care must be taken, at implementation of this subclause		N
	All parts remaining live after switching off mains supply to be protected against direct contact with at least IP2X or IPXXB	IP2X	P
	Such parts marked with warning symbol acc. to cl.17.2		P
	Excepted from this requirement for marking are:		
	- Parts that can be live only due to connection to interlocking circuits, distinguished by colour as potentially live acc. to cl. 14.2.4		N
	- Terminals of supply disconnecting device when latter mounted alone in a separate enclosure		N
c)	Opening without the use of a key or a tool and without disconnection of live parts shall be possible only when the min. protection degree is IP2X or IPXXB		N
6.2.3	Protection by insulation of live parts		P
	Live parts shall be covered by insulation which can only be removed by destruction		P
	Such insulation shall withstand the mechanical, chemical, electrical and thermal stresses under normal service conditions		P
6.2.4	Protection against residual voltages	-	
	After disconnecting, any exposed conductive part having a residual voltage that shall be discharged to 60V or less within 5 seconds	0V within 1s, comply with requirement	P
	where pins of plugs or similar devices after withdrawal are exposed, discharge time = 1s		N
	such conductors protected against direct contact by at least IP2X or IPXXB		N

EN 60204-1:2018			
Clause	Requirement-Test	Result-Remark	Verdict
	if above requirements cannot be achieved, additional disconnecting devices or appropriate warning devices shall be applied. (see cl. 13.8.4)		N
6.2.5	Protection by barriers		-
	For protection by barriers, see 412.2 of IEC 60364-4-41		N
6.2.6	Protection by placing out of reach or protection by obstacles		-
	For protection by placing out of reach see 412.4 of IEC 60364-4-41		N
	For protection by obstacles see 412.3 of IEC 60364-4-41		N
	For collector wire systems or collector bar systems with a degree of protection less than IP2X see 13.8.1		N
6.3	Protection against indirect contact		P
6.3.1	General		-
	For each circuit or part, at least one of the measures in accordance with 6.3.2 to 6.3.3 shall be applied	See the following descriptions.	P
6.3.2	Measure to prevent the occurrence of a hazardous touch voltage		P
6.3.2.1	General		-
6.3.2.2	use of class II electrical devices or apparatus (double insulation, reinforced insulation or by equivalent insulation acc. to EN 60536)	double insulation	P
	use of switchgear and control gear assemblies with total insulation acc. to EN 60439-1		P
	application of supplementary or reinforced insulation acc. to EN 60364-4-41, 413.2		P
6.3.2.3	Electrical separation of an individual circuit to prevent hazardous touch voltage acc. to EN 60364-4-41, cl. 413.5	Electrical clearance and creepage distance comply relevant requirements	P
6.3.3	Protection by automatic disconnection of supply		N
	a) Use of protective device for automatic cut-off in the event of an insulation failure in a TN – or TT-system		N
	b) Use of earth fault detection device to initiate automatic disconnection in an IT-System.		N
	initiation of warning signal only in case of first occurrence of a fault permitted		N
6.4	Protection by the use of PELV		N
6.4.1	General requirements		-
	a) nominal voltage not to exceed 25 AC (r.m.s.) or		N

EN 60204-1:2018			
Clause	Requirement-Test	Result-Remark	Verdict
	60 DC (ripple-free) or		
	6VAC or 15VDC for all other cases		N
	b) one side of PELV- circuit or one point of source of supply to be connected to PE- circuit		N
	c) live parts of PELV- circuits to be electrically separated from other live circuits.		N
	Electrical separation equal as required for safety isolating transformers (see IEC 60742)		N
	d) conductors of each PELV circuit to be physically separated from those of any other circuit.		N
	If not practicable, insulation provisions acc. to cl. 14.1.3 shall be applied		
	e) plugs and socket outlets for PELV- circuits shall conform to following requirements:		
	plugs shall not be able to enter socket outlets of other voltage systems		N
	socket outlets shall not admit plugs of other voltage systems		N
6.4.2	Sources for PELV		N
	safety isolating transformers		N
	source of current providing a degree of safety, equivalent to safety isolating transformers		N
	electrochemical or other source, independent of circuit with higher voltage		N
	electronic power supply conforming to appropriate standards		N
7	Protection of equipment		P
7.1	General		-
7.2	Over current protection		P
7.2.1	Overcurrent protection device provided	Circuit breaker and fuse have overcurrent protection function	P
7.2.2	Supply conductors		P
	The supplier is not responsible for providing the over current device for the supply conductors		P
	Installation diagram with data necessary for selection of the over current protective device	Related information is stated in the installation diagram.	P
7.2.3	Power circuits		P
	All conductors shall be protected against over current (except earthed neutral conductor)	Circuit breaker have applied to live conductors	P

EN 60204-1:2018			
Clause	Requirement-Test	Result-Remark	Verdict
		but neutral earth conductor	
	Cross-section area of neutral conductor	Cross section area for neutral equal to other phase conductor. No overcurrent for neutral conductor	P
	For neutral earth conductors with cross sections smaller than phase conductors, measures acc. to item b, cl 473.3.2.1 of IEC 60364-4-473 will apply		N
	For IT-systems use of neutral earth conductor (N) is not recommended. Nevertheless if an N-conductor is used, measures acc. to cl. 473.3.2.2 of IEC 60364-4-473 shall apply.		N
7.2.4	Control circuits		P
	Conductors of control circuits directly connected to supply voltage and circuits feeding control voltage transformers protected against overcurrent acc. to cl. 7.2.3	Circuit breaker used	P
	Control circuits fed via transformers of which one end of secondary winding is connected to PE circuit, will require overcurrent protective device only in the other secondary conductor	No winding of secondary connect to PE terminal	N
7.2.5	Socket outlets and their associated conductors		N
	Overcurrent protection devices for socket outlets provided for non-earthed live conductors of each circuit feeding such socket outlets	No socket outlets and associated conductors	N
7.2.6	Lighting circuits		N
	All unearthed conductors of local lighting circuits protected by overcurrent protective devices		N
7.2.7	Transformers		N
	Transformers shall be protected against overcurrent in accordance with the manufacturer's instructions	Not applicable	N
	Avoid unnecessary tripping due to overcurrent caused by magnetizing inrush currents		N
	Avoid temperature rise of transformer winding in excess of its permitted of its insulation class of transformer in case of short circuit at secondary terminals		N
	Type and setting of overcurrent protective device acc. to recommendations of transformer manufacturer		N
7.2.8	Location of over current protective device		P
	Overcurrent protective device located at point	located at point where	P

EN 60204-1:2018			
Clause	Requirement-Test	Result-Remark	Verdict
	where conductor is connected to the supply	conductor is connected to the supply	
	Current carrying capacity of conductors at least equal to that required for electrical load	Comply with requirement	P
	Each connecting conductor to overcurrent protective devices not longer than 3 meters	2m max.	P
	Conductor protected by enclosure or duct	By enclosure	P
7.2.9	Over current protective devices		P
	Rated short-circuit breaking capacity at least equal to prospective fault current at point of installation	Comply with requirement	P
	Current other than those coming from supply side taken into account	Comply with requirement	P
	Reduced breaking capacity is permitted, where another protective device is installed at supply side with the necessary breaking capacity		N
	Back-up protection carefully checked, no destruction of conductor or overcurrent protective device may result	Comply with requirement	P
	Co-ordination with other protective devices in circuit required		N
	Overcurrent protective devices in power circuits include fuses and circuit breakers. Electronic current limiting devices may also be used in protected circuits	Circuit breaker used	P
7.2.10	Rating and setting of over current protective devices		P
	Rated current of fuses or overcurrent setting of other protective devices selected as low as possible, but adequate for anticipated overcurrents.		P
	Settings of overcurrent protective devices appropriately listed in technical documentation	(See appended table 4.2)	P
7.3	Overload protection of motors		P
	Overload protection for all motors provided for ratings of > 0.5 kW in continuous operation.		P
	Protective device may be omitted for motors which cannot be overloaded	Can't be overloaded	P
	Overload protection achieved by current sensing or limiting devices or temperature sensors.	Thermal protection used	P
	Current overload detection provided for each live conductor except for neutral conductor	Thermal protection used	P
	For motors supplied by single phase AC or DC		N

EN 60204-1:2018			
Clause	Requirement-Test	Result-Remark	Verdict
	power supply, current detection in one non-earthed live conductor only is permitted		
	If overload protection is achieved by switching-off device, all live conductors cut from power supply except neutral conductor	Comply with requirement	P
	For special duty motors, appropriate protective devices are recommended		N
	For motors where cooling can be impaired, a built-in thermal protection is recommended		N
	Automatic restarting of motors prevented after operation of overload protective device, to avoid cause of a hazardous condition	Excessive temperature reached, motors stop, and start the motor using a start-button located on operator area	P
7.4	Abnormal temperature protection		N
	Resistance heating or similar devices which cause excessive heat, equipped with suitable overtemperature detection		N
7.5	Protection against supply interruption or voltage reduction and subsequent restoration		P
	Undervoltage protection provided for applications where loss of supply or undervoltage causes a hazardous condition		N
	If interruption or reduction of supply voltage is allowed for a short period of time, delayed undervoltage protection provided.		N
	Undervoltage protection not impair any stopping control of the machine		P
	Upon restoration of supply voltage, automatic or unexpected restarting of machine prevented		P
	Undervoltage protection to initiate appropriate control responses to ensure co-ordination the groups of machines working together		P
7.6	Motor over speed protection		P
	Overspeed protection provided where overspeeding causes a hazardous condition		P
	Overspeed protection initiates appropriate control response and prevents automatic restarting	Start machine only using start button	P
7.7	Earth fault/residual current protection		P
	To reduce damage to equipment due to earth fault currents below detection level, earth fault/residual		P

EN 60204-1:2018			
Clause	Requirement-Test	Result-Remark	Verdict
	protect used		
	Detection level for earth fault protection set as low as possible		P
7.8	Phase sequence protection		
	Where an incorrect sequence of the supply voltage can cause a hazardous condition or damage to the machine, protection shall be provided		N
7.9	Protection against over voltage due to lightning and to switching surges		P
	Protective devices for the suppression of overvoltages caused by lightning strikes or switching surges provided	Circuit breaker used	P
	Devices for suppression of overvoltages due to lightning, connected at incoming terminals of the supply disconnecting device	Circuit breaker used	P
	Devices for suppression of overvoltages due to switching surges connected across terminals of all equipment requiring such protection	Circuit breaker used	P
8	Equipotential bonding		P
8.1	General		-
8.2	Protective bonding circuit		P
8.2.1	General		-
	On mobile machines with on-board power supplies, it shall be connected to a protective bonding terminal to provide protection against electric shock	Not movable machine	N
	When a mobile machine is also capable of being connected to an external incoming supply, the protective bonding terminal shall be the connection point for the external protective conductor	Not movable machine	N
	All parts of the protective bonding circuit shall be so designed that they are capable of withstanding the highest thermal and mechanical stresses	Provided by user according to instructions	P
	Any structural part of the electrical equipment or of the machine may be used as part of protective bonding circuit		P
	If an IT distribution system is used, the machine structure shall be used as part of the protective bonding circuit in conjunction with an earth fault supervision system		P
8.2.2	Protective conductors		P
	Protective conductors shall be identified according to 14.2.2	See clause 14.2.2 in detail.	P
	Copper conductors should be used	Copper used	P
	Where a conductors material other than copper is used, its electrical resistance per unit length shall not exceed that of the allowable copper conductor	Only copper conductors are used.	N

EN 60204-1:2018			
Clause	Requirement-Test	Result-Remark	Verdict
	and such conductors shall not be less than 16 mm ² in cross-sectional area		
	The cross-sectional area of protective conductors shall be determined according to the requirements of: -543 of IEC 60364-5-54; or -7.4.3.1.7 of IEC 60439-1, as appropriate		P
	Relationship between cross-section area of phase conductor and PE acc. to table 1		P
8.2.3	Continuity of the protective bonding circuit		P
	All exposed conductive parts shall be connected to the protective bonding circuit	Connect to protective bonding circuits	P
	In case of removal of parts of PE system, remaining parts not to be interrupted	If one part removed, protective continuity not interrupted	P
	Connection and bonding points shall be so designed that their current-carrying capacity is not impaired by mechanical, chemical, or electrochemical influence	Not impaired by mechanical, chemical or electrochemical influences	P
	Particular consideration should be given if enclosure consists of aluminium and its alloys		P
	Metal ducts of flexible or rigid construction and metallic cable sheathes shall not be used as protective bonding conductors	No metal ducts and cable armouring used as or connected to protective bonding circuits	P
	Where the electrical equipment is mounted on lids, doors, or cover plates, continuity of the protective bonding circuit shall be ensured and it is recommended that a protective conductor is used	No such electrical equipment	N
	Continuity of protective conductor ensured at cables which are exposed to damage		N
8.2.4	Exclusion of switching devices from the protective bonding circuit		P
	Protective bonding circuit not incorporate a switching-/overcurrent protective device nor a means for current detection	No switching devices or any other current protective devices	P
	Interruption of protective conductors permitted by links, intended to be opened by instructed/skilled persons for test or measurement purposes by using a tool		P
8.2.5	Parts that need not to be connected to the protective bonding circuit		P
	Parts which cannot be touched on large surfaces or grasped by hand due to its small size (less than approx. 50 x 50 mm), small parts such as screws,		P

EN 60204-1:2018			
Clause	Requirement-Test	Result-Remark	Verdict
	rivets, nameplates or		
	are located in such way, that either contact with live parts or an insulation failure is unlikely		P
8.2.6	Protective conductor connecting points		P
	All protective conductors shall be terminated in accordance with 14.1.1	Please see the related clause.	P
	Shall have no other function and shall not be used to attach or connect appliances or parts	Only for earth connection	P
	Use of earthing symbol 	Earthing symbol is used.	P
	By the bicolor combination GREEN-AND-YELLOW	GREEN-AND-YELLOW	P
8.3	Functional bonding		P
	Protection against maloperation as a result of insulation failures can be achieved by connecting to a common conductor in accordance with 9.4.3.1.	See the following descriptions.	P
	For recommendations regarding functional bonding to avoid maloperation due to electromagnetic disturbances, see 4.4.2.		P
8.4	Measures to limit the effects of high leakage current		N
	The effects of high leakage current can be restricted to the equipment having high leakage current by connection of that equipment to a dedicated supply transformer having separate windings.		N
9	Control circuits and control functions		P
9.1	Control circuits		P
9.1.1	Control circuit supply		P
	Transformers shall be used for supplying the control circuits		N
	If several transformers used, secondary voltages in phase		N
	DC- control circuits connected to PE circuit supplied from a separate winding of the control circuit transformer or supplied from another control circuit transformer	DC-control circuits supplied by switching power supply	N
	Transformers not mandatory for machines with a single motor starter and maximum of two control devices		N
9.1.2	Control circuit voltages		P
	The nominal voltage shall not exceed 277 V when supplied from a transformer		N
9.1.3	Protection		P
	Over current protection shall be provided according to 7.2.4 and 7.2.10	Circuit breaker	P
9.2	Control functions		P
9.2.1	Start functions		P

EN 60204-1:2018			
Clause	Requirement-Test	Result-Remark	Verdict
	Start functions shall operate by energizing the relevant circuit	Start function applied	P
9.2.2	Stop functions		P
	Category 0: Stopping by immediate removal of power to machine actuators	Power circuit breaker	P
	Category 1: A controlled stop with power available to machine actuators. Then removal of power when stop condition has been achieved.	“STOP“ button	P
	Category 2: A controlled stop with power left available to machine actuators	Not provided	N
9.2.3	Operating modes		P
	When hazardous conditions can arise from mode selection, such selection shall be prevented by suitable means.	No hazardous conditions can arise from mode selection.	N
	Mode selection by itself shall not initiate machine operation (A separate action by the operator shall be required)	Not initiate machine operation.	P
	Safeguarding shall remain effective for all operating modes		P
	Indication of the selected operating mode shall be provided	Indication is indication.	P
9.2.4	Suspension of safety functions and/or protective measures		P
	Where it is necessary to suspend safety functions and/or protective measures (for example for setting or maintenance purposes), protection shall be ensured by:		-
	-disabling all other operating (control) modes; and		P
	-other relevant means (see 4.11.9 of ISO 12100-2:2003), that can include, for example, one or more of the following:		-
	-initiation of operation by a hold-to-run device or by a similar control device;		N
	-a portable control station with an emergency stop device and, where appropriate, an enabling device. Where a portable control station is in use, initiation of motion shall only be possible from that control station;		N
	-a cableless control station with a device to initiate stop functions in accordance with 9.2.7.3 and, where appropriate, an enabling device.		N
	-limitation of the speed or the power of motion;		N
	-limitation of the range of motion.		N
9.2.5	Operation		P

EN 60204-1:2018			
Clause	Requirement-Test	Result-Remark	Verdict
9.2.5.1	General		P
	The necessary interlocks (see 9.3) shall be provided for safe operation		N
	Measures shall be taken to prevent movement of the machine in an unintended manner after any stopping of the machine	Start machine only by start button	P
9.2.5.2	Start		P
	The start of an operation shall be possible only when all the safeguards are in place and functional (except described in 9.2.4)	all the safeguards are in place and functional	P
	Hold-to-run control shall be used for the others machines, as appropriate		N
	Suitable interlocks shall be provided to secure correct sequential starting		P
	The use of more than one control station to initiate a start	Only one control station is used.	N
9.2.5.3	Stop		P
	Category 0, category 1 and/or category 2 stops shall be provided where indicated by the risk assessment and the functional requirements of the machines	Category 0 stops are provided.	P
	Stop functions shall override related start functions	Stop functions have priorities over start functions.	P
	Facilities provided for connection of protective devices / interlocks		P
	If such protective device/ interlock causes a machine stop, it may be necessary to send such condition to the logic of the control system (PLC)		P
	Resetting of stop function must not initiate any hazardous condition	No hazard	P
9.2.5.4	Emergency operations (emergency stop, emergency switching off)		P
9.2.5.4.1	General		-
9.2.5.4.2	Emergency stop		P
	Shall function either as a category 0 stop or as a category 1 stop	Category 0 stop.	P
	The choice of the emergency stop shall be determined by the risk assessment of the machine		P
	Where a category 0 stop is used for emergency stop function, it shall have only hard-wired electromechanical components		P
	Emergency stop has priority over all other functions and over all modes of operation	Override all functions	P
	Power to machine actuators that can cause hazardous condition(s) removed as quickly as	No hazards	P

EN 60204-1:2018			
Clause	Requirement-Test	Result-Remark	Verdict
	possible without creating other hazards		
	Resetting must not initiate a restart	After reset manually, pressing start button then start machine	P
9.2.5.4.3	Emergency switching off	-	
	Functional aspects of emergency switching-off function are given in IEC 60364-4-46 and should be provided where:		N
	Protection against direct contact is achieved only by placing out of reach or by obstacles		N
	There is the possibility of other hazards or damage by electricity		N
	Emergency switching-off is accomplished by disconnecting incoming supply of the machine, effecting in a category 0 stop		N
	When a machine cannot tolerate a category 0 stop, other means of protection is to be provided so that emergency switching-off is not necessary		N
9.2.5.5	Monitoring of command actions		
	Movement or action of a machine or parts of it, that can result in a hazardous condition be monitored		P
	On manually controlled machines, operators to provide some monitoring		N
	Conditions expected to be unreasonable for monitoring by the operator, require means to monitor such conditions	Protective device for motor overspeed detection, overload detection, overcurrent dection used	P
9.2.6	Other control functions		N
9.2.6.1	Hold-to-run controls		N
	Hold-to run controls shall require continuous actuation of the control devices to achieve operation		N
9.2.6.2	Two-hand control		N
	Three types of two-hand control are available, the selection of which is determined by the assessment		N
9.2.6.3	Enabling device		N
	It shall be designed to allow motion when actuated in one position only (In any other position motion shall be stopped)		N
9.2.6.4	Combined start and stop controls		N
	Push-buttons and similar devices that, when operated, alternately initiate and stop motion shall only be used for functions which cannot result in a hazardous condition	No this kind of device has been used.	N

EN 60204-1:2018			
Clause	Requirement-Test	Result-Remark	Verdict
9.2.7	Cableless control		-
9.2.7.1	General		-
	Means shall be provided to readily remove or disconnect the power supply of the operator control station	Not applicable	N
	Means shall be provided, as necessary, to prevent unauthorized use of the operator control station		N
	Each operator control station shall carry an unambiguous indication of which machine is intended to be controlled by that operator control station		N
9.2.7.2	Control limitation		-
	Measures shall be taken to prevent the machine from responding to signals other than those from the intended operator control station		N
	Where necessary, means shall be provided so that the machine can only be controlled from operator control station in one or more predetermined zones or locations		N
9.2.7.3	Stop		-
	Operator control stations shall include a separate and clearly identifiable means to initiate the stop function of the machine or of all the motions that can cause a hazardous condition		N
	The actuating means to initiate this stop function shall not be marked or labeled as an emergency stop device		N
	A machine which is equipped with cableless control shall have a means of automatically initiating the stopping of the machine and of preventing a potentially hazardous operation		N
9.2.7.4	Use of more than one operator control station		N
	Where a machine has more than one operator control station, measures shall be taken to ensure that only one control station can be enabled at a given time		N
	An indication of which operator control station is in control of the machine shall be provided at suitable locations as determined by the risk assessment of the machine		N
9.2.7.5	Battery-powered operator control stations		-
	A variation in the battery voltage shall not cause a hazardous condition		N
	If one or more potentially hazardous motions are controlled using a battery-powered operator control station, a clear warning shall be given to the		N

EN 60204-1:2018			
Clause	Requirement-Test	Result-Remark	Verdict
	operator when a variation in battery voltage exceeds specified limits		
	Under those circumstances, the operator control station shall remain functional long enough to put the machine into a non-hazardous condition		N
9.3	Protective interlocks		-
9.3.1	Reclosing or resetting of an interlocking safeguard		N
	The reclosing or resetting of an interlocking safeguard shall not initiate machine motion or operation		N
9.3.2	Exceeding operating limits		N
	Where an operating limit (for example speed, pressure, position) can be exceeded leading to a hazardous situation, means shall be provided to detect when a predetermined limit(s) is exceeded and initiate an appropriate control action.		N
9.3.3	Operation of auxiliary functions		N
	The correct operation of auxiliary functions shall be checked by appropriate devices		N
	Use of appropriate interlocking		N
9.3.4	Interlocks between different operations and for contrary motions		N
	Interlocks of contactors, relays, etc. between different operations and for opposite motions, interlocks against such incorrect operation provided		N
	Reversing contactors interlocked in such way, that in normal service no short circuit occurs during switching operation		N
	Where, for safety or for continuous operation, certain functions on the machine are required to be interrelated, proper co-ordination ensured by suitable interlocks		N
	For a group of machines working together in a co-ordinated manner and having more than one controller, provisions made for co-ordination of this controller		N
	If a failure of a mechanical brake actuator can result that the brake, is applied when the associated machine actuator is energised and a hazardous condition results, interlocks be provided to switch off the machine actuator		N
9.3.5	Reverse current braking		N
	Reverse current braking on a motor, effective measures taken to avoid motor starting in opposite direction at end of braking where that reversal	No reverse current braking used for AC rotating motor	N

EN 60204-1:2018			
Clause	Requirement-Test	Result-Remark	Verdict
	causes a hazardous condition, damage to the machine or to the process		
	Control circuits arranged so, that rotation of a motor shaft, not to result in a hazardous condition		N
9.4	Control functions in the event of failure		P
9.4.1	General requirements		P
	Measures to reduce those risks include but are not limited to:		-
	protective devices on the machine, (e.g. interlocking guards, trip devices)	Circuit breaker have protection function	P
	protective interlocking of electrical circuit	Not used	N
	use of proven circuit techniques and components (see cl. 9.4.2.)	Conform to relevant IEC standards	P
	provision of partial or complete redundancy (see cl. 9.4.2.2) or diversity (see cl. 9.4.2.3)		N
	provision for functional tests (see cl. 9.4.2.4)	Comply with clause 19.6	P
	single failures only are to be considered		P
	Where memory retention is achieved for example, by battery power, measures shall be taken to prevent hazardous situations arising from failure or removal of the battery.	No memory retention is achieved.	N
	Means shall be provided to prevent unauthorized or inadvertent memory alteration by, for example, requiring the use of a key, access code or tool.		P
9.4.2	Measures to minimize risk in the event of failure		P
9.4.2.1	Use of proven circuit techniques and components		P
	bonding of control circuits to protective circuit for operational purposes (see cl. 9.4.3.1)		P
	connection of control devices in accordance with cl. 9.1.4		P
	stopping by de-energising (see cl. 9.2.2)		P
	switching of all live conductors to device being controlled (see cl. 9.4.3.1)		P
	use of switching devices having positive (or direct) opening operation (see IEC 60947-5-1)		P
	circuit design to reduce possibility of failures causing undesirable operations		P
9.4.2.2	Provisions of partial or complete redundancy		N
	off-line redundancy for protective functions,		N

EN 60204-1:2018			
Clause	Requirement-Test	Result-Remark	Verdict
	effective only when operating function fails		
	where off-line redundancy is use, suitable measures taken, to ensure that those control circuits are available when required		N
	on-line redundancy for normal operation		N
9.4.2.3	Provision of diversity		N
	Use of control circuits having different principles of operation or using different types of devices may reduce faults and failures. Examples include:		-
	Combination of normally open and normally closed contacts operated by interlocking guards	Not provided	N
	Use of different types of circuit components in control circuit	start button, stop button used	P
	Combination of electromechanical and electronic circuits in redundant configurations		N
	Combination of electrical and non-electrical systems (e.g. mechanical, hydraulic, pneumatic) may perform redundant functions and provide diversity		N
9.4.2.4	Provision for functional tests		P
	Automatic functional test carried out by the control system	Comply with clause 18.6	P
	Manual function tests by inspection	Comply with clause 18.6	P
	Tests at start-up and at predetermined intervals or as a	Comply with clause 18.6	P
	Combination as appropriate (see cl.17.2 and 18.6)	Comply with clause 18.6	P
9.4.3	Protection against maloperation due to earth faults, voltage interruptions and loss of circuit continuity		P
9.4.3.1	Earth faults		P
	Earth faults on any control circuit causes no unintentional starting, potentially hazardous motions or prevent stopping of machine	No motion	P
	For fulfilment of this requirement, bonding to PE-circuit provided and correct connection of devices ensured	PE circuit connected to conductor	P
	Control circuits fed from transformer and not connected to PE- circuit provided with an insulation monitoring device	Control circuits connected to PE circuits	N
	Multi-pole control switches which interrupt all live conductors use for START or STOP functions, which could cause hazardous condition or damage	No multi-pole control switches	N

EN 60204-1:2018			
Clause	Requirement-Test	Result-Remark	Verdict
	to the machine, in the event of unintentional starting or failure to stop.		
9.4.3.2	Voltage interruptions		P
	Where a memory device is used, proper functioning in the event of power failure shall be ensured to prevent any loss of memory that can result in a hazardous condition	Any loss of memory can't result in a hazardous condition.	P
9.4.3.3	Loss of circuit continuity		P
	Where the loss of continuity of safety-related control circuits depending upon sliding contacts can result in hazardous condition, appropriate measures shall be taken	No sliding contact used	N
10	Operator interface and machine-mounted control devices		P
10.1	General		P
10.1.1	General device requirements		P
	As far as is practicable, those devices shall be selected, mounted, and identified or coded according to IEC 60073 and IEC 60447	Comply with requirements	P
10.1.2	Location and mounting		P
	Machine-mounted control devices readily accessible for service and maintenance and	Readily accessible for service and maintenance	P
	Mounted to minimize possibility of damage from activities such as material handling		P
	Actuators of hand-operated control devices selected and installed as follows:		
	Mounted not less than 0.6 m above servicing level, and within easy reach for operator (normal working position)		P
	Placed so that operator is not exposed to a hazardous situation when operating them	No hazard	P
	Possibility of inadvertent operation is minimised	Marking clearly	P
10.1.3	Protection		P
	Degree of protection sufficient for expected use against:		-
	Effects of aggressive liquids, vapours or gases in environment of machine	See instruction for environment requirement	P
	Ingress of contaminants	See instruction for environment requirement	P
	Operator interface control devices have a minimum degree of protection against direct contact of IPXXD		P
10.1.4	Position sensors		N
	Position sensors shall not be damaged in the event		N

EN 60204-1:2018			
Clause	Requirement-Test	Result-Remark	Verdict
	of over travel		
	Position sensors used in circuits with safety-related functions shall have positive opening operation or shall provide similar reliability		N
10.1.5	Portable and pendant control stations		N
	Portable and pendant control stations and their control devices shall be so selected and arranged as to minimize the possibility of inadvertent machine operations caused by shocks and vibrations		N
10.2	Push-buttons		P
10.2.1	Colors		
	Push-button actuators shall be color -coded according to table 2		P
10.2.2	Markings		
	Recommendation that pushbuttons are preferably marked directly on actuator with symbols acc. to table 3	Comply with requirements	P
10.3	Indicator lights and displays		P
10.3.1	Colours for indication lights: RED, YELLOW, GREEN, BLUE Colours for confirmation: GREEN and WHITE		P
10.3.2	Colors		P
	Color-coded according to table 4 (Unless otherwise agree between the supplier and the user)	Comply with requirements	P
10.3.3	Flashing lights and displays		P
	Flashing lights for further information may be used for following purposes:		-
	to attract attention or		P
	to request immediate action or		P
	to indicate a discrepancy between command and actual state or		P
	to indicate a change in process (flashing during transition)		P
	higher frequency of flashing lights (pulse/pause ratios) recommended for higher priority of information		P
10.4	Illuminated push-buttons		N
	Illuminated push-button actuators colour-coded acc. to tables 2 and 4		N
	WHITE colour shall be use, if it is difficult in assigning an appropriate colour		N

EN 60204-1:2018			
Clause	Requirement-Test	Result-Remark	Verdict
	RED colour shall be use, for emergency stop actuators, not depending upon illumination conditions (ON /OFF status) only		N
10.5	Rotary control devices		N
	Devices having a rotational member shall be mounted to prevent rotation of the stationary member (Friction alone shall not be sufficient)		N
10.6	Start devices		P
	Start devices use to initiate start functions or movement of machine or elements designed and mounted such as to minimize inadvertent operation	Common push button used to initiate start functions or movement of machine	P
	Mushroom - type actuators use for two-hand control devices	No two-hand control devices	N
10.7	Devices for emergency stop		P
10.7.1	Location		P
	Devices for emergency stop shall be readily accessible	It is readily accessible.	P
	Emergency stop devices shall be located at each operator control station and at other locations where the initiation of an emergency stop can be required	All of them are located at each operator control station.	P
10.7.2	Types		P
	Use of type - a push-button operated switch - a pull-cord operated switch - a pedal-operated switch without a mechanical guard	Push button with mushroom head used	P
	Shall be of the self-latching type and shall have positive opening operation	Have self-latching function and positive opening operation	P
10.7.3	Colour of actuators		P
	Actuators of emergency stop devices are coloured RED	Red used	P
	Background immediately around actuator is coloured YELLOW		P
10.7.4	Local operation of the supply disconnecting device to effect emergency switching off		N
	Supply disconnecting device may be locally operated to serve as function of emergency stop when:		-
	it is readily accessible to operator		N
	it is of type described in cl. 5.3.2 a), b) or c)		N
	Supply disconnecting device shall meet colour requirements of cl. 10.7.4		N

EN 60204-1:2018			
Clause	Requirement-Test	Result-Remark	Verdict
10.8	Emergency switching off devices		N
10.8.1	Location of emergency switching-off devices normally placed separate from operator control station		N
	Operator control station equipped with separate emergency stop device, since function effects a category 0 emergency stop		N
10.8.2	Types of emergency switching-off devices include: Push-button operated switch or		N
	Pull-cord operated switch		N
	Devices of self-latching type and ensure positive (or direct) opening operation		N
	Push-button operated switch in break-glass enclosure		N
10.8.3	Actuators of emergency switching-off devices are coloured RED		N
	Background immediately around actuator (push-button) coloured YELLOW		N
	Actuators of push-button operated emergency switching-off devices be of palm- or mushroom-head type		N
10.8.4	When supply disconnecting device is locally operated for emergency switching-off, it shall be readily accessible		N
	Supply disconnecting device locally operated for emergency switching-off, shall meet colour requirement acc. to cl. 10.8.3.		N
10.9	Enabling control device		N
	When an enabling control device is provided as a part of a system, it shall signal the enabling control to allow operation when actuated in one position only.		N
11	Control gear: location, mounting, and enclosures		P
11.1	General requirements		P
	All control gear located and mounted so, as to cover the following points: facilitate accessibility and maintain ability	Accessilbe and able	P
	facilitate protection against external influences or operating conditions under which operation is intended		P

EN 60204-1:2018			
Clause	Requirement-Test	Result-Remark	Verdict
	facilitate easy access for operation and maintenance of the machine and its associated equipment	Easy access for operation and maintenance	P
11.2	Location and mounting		P
11.2.1	Accessibility and maintenance		P
	all control-gear components placed and oriented so, that identification is possible without moving them or the associated wiring	Fixed on machine	P
	Components checked for correct operation or possible replacement without dismantling other equipment or parts of the machine	Part list provided Components replacement according to detailed spec.	P
	Terminals not associated with control gear also to conform to this requirement		P
	Operation and maintenance of all control gear possible from front of cabinet	From front of cabinet, operation and maintenance possible	P
	Special tools for removal of electronic devices provided with the equipment	No special tools used	P
	Access for regular maintenance or adjustment to equipment, relevant devices located between 0.4m to 2.0 m above servicing level	1.3~1.6 m used	P
	Terminals located at least 0.2 m above servicing level and placed such, that conductors and cables can be easily connected	At least 0.2 m used	P
	No devices mounted on doors, except those for operating, indicating, measuring and cooling purposes on normally removable access-covers of enclosure	No devices mounted on doors	P
	Plug-in type control devices belonging functionally together, their association made clear by type (shape), marking or reference designation single or in combination (see cl. 14.4.5)	No plug-in type control devices	N
	Plug-in type control devices, that are handled during normal operation, shall be designed with non-interchangeable characteristics, where lack of such facility can result in malfunctioning	No plug-in type control devices	N
	Use of plug/socket combinations shall be unobstructed access	Not applicable.	
	Plug/socket combinations, handled during normal operation, shall be located and mounted so as to provide unobstructed access	No plug/socket combination	N
	If test points are provided, they should be:		

EN 60204-1:2018			
Clause	Requirement-Test	Result-Remark	Verdict
	mounted so as to provide unobstructed access		N
	clearly marked to correspond with the documentation (see cl. 18.3)		N
	adequately insulated		N
11.2.2	Physical separation or grouping		
	Non-electrical parts and devices, not directly associated with the electrical equipment, not located within enclosures containing control gear	Not in enclosure	P
	Devices such as solenoid valves separated from other electrical equipment		P
	Control devices mounted at same location and connected to the main supply voltage, or to both main supply and control voltage, are grouped separately from those connected to control voltage only		P
	Terminals separated into groups for: power circuits or	Terminals separated for power circuits	P
	associated control circuits or	Terminals separated for control circuits	P
	other control circuits, fed from external sources		N
	Terminal groups mounted adjacently, providing that each group is readily identified	Readily identification	P
	When arranging the location of devices, clearances and creepage distances specified for them shall be maintained, taking into account external influences or physical conditions of its environment	Comply with requirements	P
11.2.3	Heating effects		P
	Heat generating components shall be located so that the temperature of each component in the vicinity remains within the permitted limit	Comply with requirements	P
11.3	Degrees of protection		P
	Protection of control gear against ingress of solid foreign objects and liquids shall be adequate. External influences under which the equipment is intended to operate is to be taken into account and is to be		P
	Its protection sufficient against dust, coolants and swarf		P
	Enclosures of control gear provide a degree of protection of at least IP20	IP20	P

EN 60204-1:2018			
Clause	Requirement-Test	Result-Remark	Verdict
	Exceptions:		
	a) Where an electrical operating area is use as a protective enclosure for an appropriate degree of protection against ingress of solid bodies and liquids		P
	b) Where removable collectors on collector bar systems are use, and IP55 is not achieved but measures of cl. 6.2.5 are applied		N
11.4	Enclosures, doors and openings		P
	Enclosures to withstand mechanical, electrical and thermal stress as well as effects of humidity during normal service	Metal with insulated materials to withstand mechanical,electrical and thermal stress	P
	Fasteners for doors or covers of captive type	Hinges, lock used	P
	Windows for viewing internally mounted indicating devices, made of material suitable to withstand mechanical stress and chemical attack	Not provided	N
	Doors of enclosure not wider than 0,9 meter		P
	Doors with vertical hinges	Vertical hinges used	P
	Doors with opening angle of at least 95 °		P
	Gaskets of doors, lids, covers and enclosures withstand the chemical effects of aggressive liquids, vapours or gases use on the machine	Comply with requirement	P
	Means use to maintain degree of protection of an enclosure of doors, lids and covers that require opening or removed for operational or maintenance shall:		-
	be securely attached to either door, cover or enclosure	Securely attached to door	P
	not deteriorate due to removal or replacement of door or cover and so impair degree of protection		P
	all openings in enclosure closed by supplier(s), ensuring degree of protection specified for equipment		P
	openings for cable entries at enclosure to be easily re-opened on site	Rubber cushion used for hole on inside-enclosure	P
	suitable opening in base of enclosure within the machine provided, as to enable drainage of moisture due to condensation		P
	no opening between enclosure containing electrical equipment and compartment containing coolant,		P

EN 60204-1:2018			
Clause	Requirement-Test	Result-Remark	Verdict
	lubricating or hydraulic fluids		
	holes in enclosure for mounting purposes not impair required degree of protection	Not impair required degree of protection	P
	If equipment could attain a surface temperature sufficient to cause a risk of fire during normal or abnormal operation:		-
	located within an enclosure, that can withstand, without risk of fire or harmful effect, the heat emitted by the equipment or		N
	mounted and located at sufficient distance from adjacent equipment, so as to allow safe dissipation of heat or		N
	otherwise screened by material that can withstand, without risk of fire or harmful effect, the heat emitted by the equipment		N
11.5	Access to control gear		
	Minimum dimensions of doors and corridors for access to electrical operating areas: at least 0.7 meter wide and 2.0 meter high		P
	Doors open outwards	Open outwards	P
	Doors equipped with means to allow opening from inside without the use of a key or tool	Not provided	N
12	Conductors and cables		P
12.1	General requirements		P
	Conductors and cables selected so as to be suitable for operating conditions and external influences that are existing	Input cables and outer ground bonding conductors are supplied by user according to instructions	P
	Requirements not applicable for integral wiring of assemblies, subassemblies and devices that are manufactured and tested acc. to their relevant standard	Conform to relevant IEC standards	P
12.2	Conductors		P
	Conductors shall be of copper	Copper.	P
	Conductors of any other material shall have a nominal cross-sectional area such that, carrying the same current, the max. temperature shall not exceed the value given in table 5	Only copper conductors are used.	P
	If aluminium is used, the cross-sectional area shall be at least 16mm ²	Only copper conductors are used.	P
	All conductors that are subject to frequent movement shall have flexible stranding of class 5 or class 6 (see table C.4)	Comply with requirement	P

EN 60204-1:2018			
Clause	Requirement-Test	Result-Remark	Verdict
12.3	Insulation		P
	Types of insulation include: Polyvinyl chloride (PVC)	PVC used	P
	Rubber, natural and synthetic		N
	Silicone rubber (SiR)		N
	Mineral		N
	Cross-linked Polyethylene (XLPE)		N
	Ethylene Propylene Rubber compound (EPR)		N
	Poly-Tetra-Fluor-Ethylene (PTFE)		N
	Where insulation of conductors or cables can constitute hazards due to propagation of fire or emission of toxic/ corrosive fumes, guidance from cable supplier to be sought		N
	Special attention to integrity of a circuit having a safety-related function		N
	Dielectric strength of insulation adequate for required test voltage with a min. of 2000VAC for cables operating with voltages >50V AC or >120 VDC	2000V, no breakdown	P
	For separate PELV circuits, dielectric strength adequate for test voltage of 500VAC for a duration of 5 minutes		N
	Mechanical strength and thickness of insulation such that, insulation cannot be damaged during cable laying or in operation	Not be damaged during cable laying or in operation	P
12.4	Current-carrying capacity in normal service		P
	The current-carrying capacity depends on several factors, for example insulation material, number of conductors in a cable, design (sheath), methods of installation, grouping and ambient temperature.		P
	Current-carrying capacities for PVC insulated wiring between enclosures and individual items of equipment under steady-state conditions according to values given in table 6		P
12.5	Conductor and cable voltage drop		P
	The voltage drop for conductors and cables shall not exceed 5% of the nominal voltage		P
12.6	Flexible cables		P
12.6.1	General		P
	Flexible cables shall have class 5 or class 6 conductors		P

EN 60204-1:2018			
Clause	Requirement-Test	Result-Remark	Verdict
	cables exposed to severe duties shall be of adequate construction to protect against:		-
	abrasion due to mechanical handling and dragging across rough surfaces		P
	kinking to operation without cable guides		P
	stress resulting from guide rollers and forced guiding, being wound and re-wound on cable drums		P
12.6.2	Mechanical rating		P
	Cable handling system of machine designed such, as to keep tensile stress of conductors as low as practicable during machine operation		P
	tensile stress for copper conductors not to exceed 15 N/mm ² of copper cross section area		P
	where tensile stress of conductors is exceeding 15 N/mm ² , cables of special design are use		N
	maximum stress for flexible cables agreed with the cable manufacturer		P
12.6.3	Current-carry capacity of cables wound on drums		N
	Cables wound on drums selected such, as the maximum allowable conductor temperature is not exceeded	Not be wound on drums	N
	cables for circular cross-section area, installed on drums, max. current-carrying capacity in free air as declared acc. to table 7		N
12.7	Collector wires, collector bars and slip-ring assemblies		P
12.7.1	Protection against direct contact		P
	They shall be installed or enclosed in such way, that during normal access to the machine, protection against direct contact is achieved by application by one of the following protective measures:		-
	protection by partial insulation of live parts		P
	protection by enclosure or barriers provide a degree of protection of at least IP2X		P
	horizontal top surfaces of barriers or enclosures which are readily accessible provide a degree of protection of at least IP4X		P
	if required degree of protection is not achieved, protection by placing live parts out of reach in combination with emergency switching-off acc. to cl. 9.2.5.4.3 applied		N
	collector wires and bares placed such and / or protected as to prevent contact, especially for		P

EN 60204-1:2018			
Clause	Requirement-Test	Result-Remark	Verdict
	unprotected wires and bars, with conductive items such as, cords of pull-cord switches, strain-relief devices and drive chains and		
	prevent damage from a swinging load		P
12.7.2	Protective conductor circuit		P
	Where collector wires, collector bars and slip-ring assemblies are installed as part of the protective bonding circuit(PE), they shall not carry current in normal operation		P
	The continuity of the protective conductor circuit using sliding contacts shall be ensured by taking appropriate measures	Not use sliding contacts	N
12.7.3	Protective conductor current collectors		N
	Protective conductors of current collectors have a shape or are designed such, so that they are not interchangeable with other current collectors of the sliding contact type		N
12.7.4	Removable current collectors with a disconnect function		N
	Shall be so designed that the protective conductor circuit is interrupted only after the live conductors have been disconnected, and the continuity of the protective conductor circuit is re-established before any live conductor is reconnected		N
12.7.5	Clearance in air		P
	Clearances between respective conductors and between adjacent systems of collector wires, bars, slip-ring assemblies and their current collectors designed for operation in pollution degree III conditions		P
12.7.6	Creepage distances		P
	Creepage distances between the respective conductors, between adjacent systems of conductor wires, conductor bars and slip-ring assemblies, and their current collectors shall be suitable for operation in the intended environment, for example open air (IEC 60664-1), inside buildings, protected by enclosures.		P
	In abnormally dusty, moist or corrosive environments, following creepage distances apply:		
	for unprotected collector wires, bars and slip-ring assemblies equipped with insulators, the minimum creepage distance is 60 mm		N
	for enclosed collector wires, insulated multipole		N

EN 60204-1:2018			
Clause	Requirement-Test	Result-Remark	Verdict
	collector bars and insulated individual collector bars, the minimum creepage distance is 30 mm		
	gradual reduction of insulation values due to unfavourable ambient conditions regarded		N
12.7.7	Conductor system sectioning		P
	Suitable design measures taken, in order to prevent energisation of adjacent sections by current collectors themselves	Suitable design measures taken	P
12.7.8	Construction and installation of collector wire, collector bar systems and slip-ring assemblies		P
	Collector wires, collector bar systems and slip-ring assemblies use for power circuits kept separately from those use for control circuit applications	Kept separately	P
	above systems capable of withstanding without damage to mechanical forces and thermal effects of short circuit currents		P
	removable covers to above systems, laid underground or under floor, designed that they cannot be opened by one person without the use of a tool		N
	collector bars which are installed in a common metal enclosure, the individual section of it bonded together and earthed at several points depending upon their length		P
	Metal covers of collector bars laid underground or under floor, bonded together end earthed		N
	Underground and under floor collector bar ducts have drainage facilities		N
13	Wiring practices		P
13.1	Connections and routing		P
13.1.1	General requirements		P
	All connections shall be secured against accidental loosening	Fixed by screws	P
	The means of connection shall be suitable for the cross-sectional areas and neutral of the conductors being terminated	Fixed by screws	P
	The connection of two or more conductors to one terminal is permitted (only when the terminal is designed for that purpose)	No terminal has been connected with three or more conductors.	P
	One protective bonding circuit conductor shall be connected to one terminal connecting point	One conductor connected to one terminal.	P
	Soldered connections shall only be permitted if terminals are suitable for soldering	No soldered connection has been taken.	N

EN 60204-1:2018			
Clause	Requirement-Test	Result-Remark	Verdict
	Terminals on terminal blocks shall be plainly identified to correspond with markings on the diagrams	All of them have been marked corresponding to markings on the diagrams.	P
	The installation of flexible conduits and cables shall be such that liquids shall drain away from the fittings	No liquids	N
	Means to retain stranded conductors together when terminating conductors at terminals/ devices provided		P
	Solder not use for that purpose	No solder used	N
	Shielded conductors terminated so, as to prevent fraying of strands and to permit easy disconnection		N
	Identification tags shall be legible, permanent, and appropriate for the physical environment	The tags are legible, permanent, and appropriate for the physical environment.	P
	Terminal blocks shall be so mounted and wired, that the internal and external wiring does not cross over the terminals	No conductor cross over the terminals.	P
13.1.2	Conductor and cable runs		P
	Shall be run from terminal to terminal without splices or joints	All of them are run from terminal to terminal without splices or joints.	P
	If it is necessary to connect and disconnect cables assemblies, a sufficient extra length shall be provided	sufficient extra length	P
	The terminations of cables shall be adequately supported to prevent mechanical stresses at the terminations of the conductors	Adequate support measure has been taken.	P
	The protective conductor shall be placed close to the associated live conductors in order to decrease the impedance of the loop.		P
13.1.3	Conductors of different circuits		P
	Conductors of different circuits laid side by side and occupy the same duct or be in same multiconductor cable, provided that such arrangement does not impair proper functioning of respective circuits	Conductor for different circuits laid side by side or occupy the same duct	P
	Where circuits operate at different voltage levels, conductors separated by suitable barriers or insulated for maximum voltage to which any conductor within the same duct is subjected	Enough insulation provided	P
13.1.4	Connection between pick-up and pick-up converter of an inductive power supply system		P

EN 60204-1:2018			
Clause	Requirement-Test	Result-Remark	Verdict
	The cable between the pick-up and the pick-up converter as specified by the manufacturer of the inductive power supply shall be:		-
	as short as practicable;		P
	adequately protected against mechanical damage.		P
13.2	Identification of conductors		P
13.2.1	General requirements		P
	Conductors shall be identifiable at each termination according to the technical documentation (see clause 17)	Identification at each termination	P
	Conductors are identified by number, alphanumeric, colour (either solid or with one or more stripes), or a combination of colour and numbers or alphanumeric.	A combination of colour and numbers or alphanumeric.	P
	When numbers are used, they shall be Arabic; letters shall be Roman (either upper or lower case).	Arabic and Roman	P
13.2.2	Identification of the protective conductor		P
	Shall be really distinguishable by shape, location, marking or color	By marking and color.	P
	When identification is by color alone, the bicolor combination GREEN-AND YELLOW shall be used	By GREEN-AND-YELLOW.	P
	For the bicolor combination GREEN-AND YELLOW : one of the color covers at least 30% and not more than 70% of the surface of the conductor, the other color covering the remainder of the surface		P
	Use of graphical symbol 	The earthing symbol has been used.	P
13.2.3	Identification of the neutral conductor		P
	The color shall be Light Blue	Light blue.	P
	LIGHT BLUE must not be use for identification of any other conductor where confusion is possible	No other conductors use LIGHT BLUE.	P
	Where bare conductors are use as neutral conductors and identification by colour is use, they either be coloured by LIGHT BLUE stripes, 15 to 100 mm wide in each compartment or unit, or at each accessible position		N
	Bare conductor colour coloured LIGHT BLUE over its full length		N
13.2.4	Identification by colour		P
	Identification of other conductors by colour, number, alphanumeric or a combination of colour and numbers or alphanumeric		P

EN 60204-1:2018			
Clause	Requirement-Test	Result-Remark	Verdict
	When numbers are use, they are in Arabic writing ; letters are in Roman characters		P
13.3	Wiring inside enclosures		P
	Panel wiring supported where necessary to keep it in place	Fixed by screws	P
	Non-metallic ducts permitted only when they are of flame-retardant insulating material		N
	Electrical equipment mounted inside cabinets, designed to permit modification of wiring from front of cabinet (see cl. 11.2.1)		P
	Where that is not possible, access, doors or swing out panels provided	Doors provided	P
	Connections to devices mounted on doors or to other movable parts made with flexible conductors (acc. to cl.13.2) to allow for frequent movement of those parts		N
	Conductors be anchored to the fixed part and the movable part, independently of the electrical connection	Fixed by screws and rubber cushion anchor	P
	Conductors and cables that do not run in ducts are adequately supported		P
	Terminal blocks or plug /socket combinations use for control wiring, that extends beyond the enclosure	Terminal blocks used for control wiring that extend beyond the enclosure	P
	Power cables and cables for measuring-circuits are directly connected to terminals of field located devices		P
13.4	Wiring outside enclosures		P
13.4.1	General requirements		P
	The protection degree shall be ensured when cables or ducts are introduced into the enclosure	The protection degree can be secured.	P
13.4.2	External ducts	-	
	Shall be enclosed in suitable ducts as described in 13.5 except for suitably protected cables	Only power cord located outside of enclosure, provided by user according to instructions	P
	Exempt from above requirements are suitably protected cables, installed without ducts and with or without use of open cable trays or cable supporting means		N
	Fittings used with ducts or multiconductor cable shall be suitable for the physical environment		P

EN 60204-1:2018			
Clause	Requirement-Test	Result-Remark	Verdict
	Flexible conduction or flexible multiconductor cable shall be used where it is necessary to employ flexible connections to pendant push-button stations		N
	The weight of the pendant stations shall be supported by means other than the flexible conduit or the flexible multiconductor cable		N
	Flexible conduit or flexible multiconductor cable shall be used for connections involving small or infrequent movements		N
13.4.3	Connection to moving elements of the machine		N
	Connection to frequently moving parts shall be made using conductors according to 12.2 and 12.6	Not used	N
	Flexible cable and flexible conduit shall be so installed as to avoid excess flexing and straining, particularly at the fittings		N
	Cables subject to movement shall be supported in such a way that there is no mechanical strain on the connection points nor any sharp flexing		N
	If the requirement mentioned above is achieved by using of a loop, it shall have sufficient length to provide for a bending radius of the cable of at least 10 times the diameter of the cable		N
	Flexible cables of machines installed or protected in such way, as to minimise the possibility of external damage due to factors, that include the following cable use or potential abuse:		N
	being run over by the machine itself		N
	being run over by vehicles or other machines		N
	coming into contact with the machine structure during movements		N
	running in and out of cable baskets or, on / off cable drums		N
	acceleration and wind forces on festoon systems or suspended cables		N
	excessive rubbing by cable collector		N
	exposure to excessive radiated heat		N
	Cable sheath resistant to normal wear expected from normal movement and effects of atmospheric contaminants		N
	If cables subject to movement are close to moving parts, it shall have a space of at least 25 mm between the moving parts and the cables		N
	Where the distance mentioned above is not		N

EN 60204-1:2018			
Clause	Requirement-Test	Result-Remark	Verdict
	practicable, fixed barriers shall be provided between the cables and the moving parts		
	The cable handing system shall be so designed that the lateral cable angles do not exceed 5°, avoiding torsion in the cable		N
	Measures shall be taken to ensure that at least two turns of flexible cables always remain on a drum		N
	Min. permitted bending radii for the forced guiding of flexible cables shall not be less than the values given in table 8		N
	The strength section between section between two bends in an S-shaped length or a bend into another plane shall be at least 20 times the diameter of the cable		N
	Where flexible conduit is adjacent to moving parts, the construction and supporting means shall prevent damage to the flexible conduit under all conditions of operation		N
13.4.4	Interconnection of devices on the machine		P
	The connections shall be conveniently placed, adequately protected, and shown on the relevant diagrams	Conductor connector terminal used	P
	Intermediate terminals are adequately protected		P
	Intermediate terminals are indicated on the wiring diagram		P
	This enables easy access for testing purposes		P
13.4.5	Plug/socket combinations		N
	Where plug/socket combinations are provided, they shall fulfil one or more of the following requirements as applicable:	No plug/socket combinations are provided.	N
	a) When installed correctly in accordance with f), plug/socket combinations shall be of such a type as to prevent unintentional contact with live parts at any time, including during insertion or removal of the connectors. The degree of protection shall be at least IPXXB. PELV circuits are excepted from this requirement.		N
	b) Have a first make last break protective bonding contact (earthing contact) (see also 6.3, 8.2.4) if used in TN- or TT-systems.		N
	c) Plug/socket combinations intended to be connected or disconnected during load conditions shall have sufficient load-breaking capacity. Where the plug/socket combination is rated at 30 A, or greater, it shall be interlocked with a switching device so that the connection and disconnection is		N

EN 60204-1:2018			
Clause	Requirement-Test	Result-Remark	Verdict
	possible only when the switching device is in the OFF position		
	d) Plug/socket combinations that are rated at more than 16 A shall have a retaining means to prevent unintended or accidental disconnection.		N
	e) Where an unintended or accidental disconnection of plug/socket combinations can cause a hazardous situation, they shall have a retaining means.		N
	The installation of plug/socket combinations shall fulfil the following requirements as applicable:		N
	f) The component which remains live after disconnection shall have a degree of protection of at least IP2X or IPXXB, taking into account the required clearance and creepage distances. PELV circuits are excepted from this requirement.		N
	g) Metallic housings of plug/socket combinations shall be connected to the protective bonding circuit. PELV circuits are excepted from this requirement.		N
	h) Plug/socket combinations intended to carry power loads but not to be disconnected during load conditions shall have a retaining means to prevent unintended or accidental disconnection and shall be clearly marked that they are not intended to be disconnected under load.		N
	i) Where more than one plug/socket combination is provided in the same electrical equipment, the associated combinations shall be clearly identifiable. It is recommended that mechanical coding be used to prevent incorrect insertion.		N
	j) Plug/socket combinations used in control circuits shall fulfil the applicable requirements of IEC 61984. Exception: see item k).		N
	k) Plug/socket combinations intended for household and similar general purposes shall not be used for control circuits. In plug/socket combinations in accordance with IEC 60309-1, only those contacts shall be used for control circuits which are intended for those purposes.		N
13.4.6	Dismantling for shipment		P
	If wiring needs to be disconnected for shipment, terminals or plug/socket combinations are provided at the disconnecting points	Internal wiring is located fully for shipment, and input terminal for power cords provided	P
13.4.7	Additional conductors		P
	Consideration should be given to providing additional conductors for maintenance or repair. Spare conductors shall be connected to spare	Providing additional conductors for maintenance and repair.	P



EN 60204-1:2018			
Clause	Requirement-Test	Result-Remark	Verdict
	terminals or isolated to prevent contact with live parts.		
13.5	Ducts, connection boxes and other boxes		P
13.5.1	General requirements		P
	Min. protection degree for ducts: IP 33		P
	All sharp edges, flash, burrs, rough surfaces or threads which the insulation of conductors may come into contact, removed from ducts and conduits	Edges smooth	P
	In order to avoid confusion between conduits for electrical installation and those for oil, water or air, either physically separated or suitably identified	Physically separated	P
	Ducts or cable trays rigidly supported and positioned at sufficient distance from moving parts		N
	Ducts or cable trays mounted at least 2 meters above the working surface in areas where human passage is required	Not for human passage	N
	Ducts provided only for mechanical protection (see cl. 8.2.3)	Only for mechanical protection	P
	Cable trays which are partially covered, not to serve as cable trays or installation trunking		N
	Conductors and cables suitable for installation in cable trays		P
13.5.2	Percentage fill of ducts		P
	The dimensions and arrangement of the ducts be such as to facilitate the insertion of the conductors and cables		P
13.5.3	Rigid metal conduit and fittings		N
	Shall be of galvanized steel or of a corrosion-resistant material	No rigid metal conduit is used.	N
	Conduits shall be securely held in place and supported at each end	No rigid metal conduit is used.	N
	Fitting shall be threaded	No rigid metal conduit is used.	N
	Where threadless fittings are used, the conduit shall be securely fastened to the equipment	No rigid metal conduit is used.	N
	The conduit shall not be damage and the internal diameter of the conduit shall not e effectively reduced when it is bent	No rigid metal conduit is used.	N
13.5.4	Flexible metal conduit and fittings		N
	Flexible metallic conduits and fittings consist of flexible metal tubing or wire mesh armour.	Not used flexible metallic conduits	N
	They are suitable for its application and	Not used flexible metallic	N

EN 60204-1:2018			
Clause	Requirement-Test	Result-Remark	Verdict
	environmental conditions	conduits	
13.5.5	Flexible non-metal conduit and fittings		P
	Flexible non-metallic conduits are resistant to buckling and with similar characteristics as the sheath of multicore cables		P
	They shall be suitable for its application and environmental conditions		P
	Joints and fittings compatible with conduits and appropriate for its application	Fixed by metal loop on machine	P
13.5.6	Cable trunking systems		
	Shall be rigidly supported and clear of all moving or contaminating portions of the machine	Comply with the requirement	P
	Covers shall be shaped to overlap the sides; gasket shall be permitted		P
	Covers shall be attached to cable trunking systems by hinges or chain and held closed by means of captive screws or other suitable fasteners		P
	On horizontal cable trunking systems, the cover shall not be on the bottom	Comply with the requirement	P
	Where the cable trunking system is furnished in sections, the joints between sections shall fit tightly but need not be gasketed		P
	The only openings permitted shall be those required for wiring or for drainage		P
	Cable trunking systems shall not have opened but unused knockouts	Comply with the requirement	P
13.5.7	Machines compartments and cable trunking systems		
	The use of compartments or cable trunking systems within the column or base of a machine to enclose conductors is permitted provided the compartments or cable trunking systems are isolated from coolant or oil reservoirs and are entirely enclosed. Conductors run in enclosed compartments and cable trunking systems shall be so secured and arranged that they are not subject to damage.	Comply with the requirement	P
13.5.8	Connection boxes and other boxes		P
	Cable connection boxes and junction boxes use for wiring purposes are readily accessible for maintenance (see cl. 11.3)	Readily accessible for maintenance	P
	They provide protection against ingress of solids or liquids, taking into account external influences during operation of the machine (see cl. 11.3)	Enclosed metal enclosure used except for hole for external cable connection and openings for vent.	P
	Junction boxes not have openings for cable entries	Not used	N

EN 60204-1:2018			
Clause	Requirement-Test	Result-Remark	Verdict
	and are designed so, as to avoid ingress of entrained dust, lubricants and coolant		
13.5.9	Motor connection boxes		P
	Shall enclose only connections to the motor and motor-mounted devices	They enclose only connections to the motor and motor-mounted devices.	P
14	Electric motors and associated equipment		P
14.1	General requirements		P
	Electric motor should conform to the requirements of IEC 60034-1		P
	Electric motors and associated equipment protected against following risks:		-
	overcurrent (see cl. 7.2)		P
	thermal overload (see cl. 7.3)		P
	overspeed (see cl. 7.6)		P
	Compliance ensured with the requirements stated (see clauses 5.3, 5.4, 5.5, 7.5, 7.6 and 9.4)		P
	Motor control equipment shall be located and mounted according to clause 11	According to clause 11.	P
14.2	Motor enclosures		P
	Selection of motor enclosure recommended acc. to EN 60034-5	Conform to EN 60034-5	P
	Degree of protection at least IP23		P
	Incorporated motors mounted such, as to provide adequate protection against mechanical damage		P
14.3	Motor dimensions		p
	Dimensions of motors conform to those given in IEC regulations (see EN 60072-1 and EN 60072-2)	conform to EN 60072-1 and EN 60072-2	P
14.4	Motor mounting and compartments		P
	Each motor with associated coupling, belt, pulley or chain mounted such, as to provide adequate protection and easy access for inspection, maintenance, adjustment or alignment, lubrication and replacement		P
	Motors mounted such, as to allow easy access to all terminal boxes		P
	Motors mounted such, as to ensure proper cooling Temperature rise to be within limits of relevant		P

EN 60204-1:2018			
Clause	Requirement-Test	Result-Remark	Verdict
	insulation class		
	Temperature rise within limits of relevant insulation class		P
	If possible, motor compartments stay clean and dry and when required, ventilated directly to the outside of the machine		P
	Motor-vents at an acceptable level and designed such, as to avoid ingress of swarf, dust or water spray		P
	No opening between motor compartment and any other compartment, which does not fulfil the requirement for motor compartments		P
14.5	Criteria for motor selection		P
	Electric motors selected acc. to service and environmental conditions		P
	Design criteria for evaluation include: type of motor and		P
	type of duty cycle (see IEC 60034-1) and	S1	P
	fixed speed or variable speed operation and	Variable speed operation	P
	mechanical vibrations and	Comply with requirement	P
	type of converter for motor speed control and		P
	influence of the harmonic spectrum of voltage and/or current when supplied from static converter on the temperature rise and		P
	method of starting and possible influence of inrush current		P
	variation of counter torque load with time and speed		P
	influence of loads with large inertia and		P
	influence of constant torque or constant power operation and		P
	possible need of inductive reactors between motor and converter		P
14.6	Protective devices for mechanical brakes		P
	Operation of overload or overcurrent protective devices for mechanical brake-actuators initiate simultaneous de-energisation(release) of associated machine actuators		P
15	Accessories and lightning		N
15.1	Accessories		N

EN 60204-1:2018			
Clause	Requirement-Test	Result-Remark	Verdict
	Where the machine or its associated equipment is provided with socket-outlets for auxiliary equipment, the following will apply:	No provided with socket-outlets	N
	the socket-outlets should conform to IEC 60309-1.		N
	if not possible, they are clearly marked with voltage and current ratings		N
	continuity of protective bonding circuit to be ensured		N
	all unearthed conductors connected to socket-outlets, protected against overcurrent		N
	when required, protection against overload in accordance with cl. 7.2 and cl. 7.3 separately from protection of other circuits		N
	if power supply to socket-outlets is not disconnected, than requirements of cl.5.3.5 apply		N
15.2	Local lighting of the machine and equipment		N
15.2.1	General		N
	Connections to the protective bonding circuit according to 8.2.2		N
	The ON-OFF switch shall not be incorporated in the lamp holder or in the flexible connecting cords		N
	Stroboscopic effects from lights shall be avoided		N
	Where fixed lighting is provided in an enclosure, electromagnetic compatibility should be taken into account using the principles outlined in 4.4.2.	No fixed lighting is provided in an enclosure	N
15.2.2	Supply		N
	The nominal voltage of the local lighting circuit shall not exceed 250 V between conductors. A voltage not exceeding 50 V between conductors is recommended.		N
	Lighting circuits supplied from one of the following sources:		-
	from a dedicated isolating transformer connected to load side, overcurrent protection provided in secondary circuit or		N
	a dedicated isolating transformer connected to line side provided, source permitted for maintenance purpose. lighting circuits placed in control enclosures only, overcurrent protection provided in secondary circuit or		N
	from a machine-circuit with dedicated overcurrent protection or		N

EN 60204-1:2018			
Clause	Requirement-Test	Result-Remark	Verdict
	an isolating transformer connected to the line side of the supply disconnecting device, provided with a dedicated primary disconnecting means (see 5.3.5) and secondary overcurrent protection, and mounted within the control enclosure adjacent to the supply disconnecting device (see also 13.1.3);		N
	an externally supplied lighting circuit (for example factory lighting supply).		N
15.2.3	Protection		N
	Local lighting shall be protected according to 7.2.6		N
15.2.4	Fittings		N
	Adjustable lighting fittings shall be suitable for the physical environment		N
	The lamp holders shall be: According to the relevant IEC publication; Constructed with an insulating material protection the lamp cap so as to prevent unintended contact		N
	Reflectors shall be supported by a bracket and not by the lamp holder		N
16	Marking, warning signs and reference designations		P
16.1	General		P
	Warning signs, nameplates, markings, and identification plates of sufficient durability to withstand the physical environment involved	Comply with requirement	P
16.2	Warning signs		P
16.2.1	Electric shock hazard		P
	Enclosures that do not otherwise clearly show that they contain electrical equipment that can give rise to a risk of electric shock shall be marked with the graphical symbol: 	Marked 	P
	The warning sign shall be plainly visible on the enclosure door or cover	It is plainly visible on the enclosure door.	P
	The warning sign may be omitted for:		-
	an enclosures equipped with a supply disconnecting device or		N
	an operator machine interface or for a control station or		P
	a single device with its own enclosure		N
16.2.2	Hot surfaces hazard		N
	Where the risk assessment shows the need to warn against the possibility of hazardous surface temperatures of the electrical equipment, the graphical symbol IEC 60417-5041 (DB:2002-10)		N

EN 60204-1:2018			
Clause	Requirement-Test	Result-Remark	Verdict
	shall be used. 		
16.3	Functional identification		P
	Control devices, visual indicators and displays use for man - machine interfaces clearly and durably marked with regard to their functions either on, or adjacent to it	Marking clear and durable	P
	such markings as agreed between user and supplier		P
	preference given to the use of standard symbols	According to standard	P
16.4	Marking of equipment		P
	Equipment (for example controlgear assemblies) shall be legibly and durably marked in a way that is plainly visible after the equipment is installed.	They have been marked legibly and durably.	P
	A nameplate giving the following information shall be attached to the enclosure adjacent to each incoming supply:		-
	name or trade mark of supplier;	See the nameplate	P
	certification mark, when required;	See the nameplate	P
	serial number, where applicable;		N
	rated voltage, number of phases and frequency (if a.c.), and full-load current for each supply;	See the nameplate	P
	short-circuit rating of the equipment;	See the nameplate	P
	main document number (see IEC 62023).		N
	The full-load current shown on the nameplate shall be not less than the running currents for all motors and other equipment that can be in operation at the same time under normal conditions.	See the nameplate	P
	Where only a single motor controller is used, that information may instead be provided on the machine nameplate where it is plainly visible.		P
16.5	Reference designations	-	
	All enclosures, assemblies, control devices, and components shall be plainly identified with the same reference designations as shown in the technical documentation	See circuit diagram	P
17	Technical documentation		P
17.1	General		P
	The information necessary for installation, operation, and maintenance of the electrical equipment of a machine shall be supplied in the form of drawings, diagrams, charts, tales and instructions	All the information have been provided by many forms in the instruction.	P
	The information shall be in an agreed language	In English.	P
	For very simple equipment, the relevant information may be contained in one document, provided that		P

EN 60204-1:2018			
Clause	Requirement-Test	Result-Remark	Verdict
	the document shows all the devices of the electrical equipment and enables the connections to the supply network to be made.		
17.2	Information to be provided		P
	Information provided with electrical equipment shall include:		-
	a) A main document (parts list or list of documents);		P
	b) Complementary documents including:		-
	1)a clear, comprehensive description of the equipment, installation and mounting, and the connection to the electrical supply(ies);	See instruction	P
	2) electrical supply(ies) requirements;	See instruction	P
	3) Information about the physical environment	See instruction	
	4) Overview (block) diagram(s)	Provided by manufacturer	P
	5) Circuit / wiring diagram(s)	Provided by manufacturer	P
	6) information about:		
	- programming, as necessary for use of the equipment;		P
	- Sequence of operation(s)	See instruction	P
	-Frequency of inspection	See instruction	P
	-Frequency and method of functional testing	See instruction	P
	-Guidance on the adjustment, maintenance and repair, particularly of the protective devices and circuits	See instruction	P
	-recommended spare parts list; and	See instruction	P
	-list of tools supplied.	See instruction	P
	7) Description of safeguards, interlocking functions and interlocking of separating safeguards for dangerous movements of co-ordinated operating machines	See instruction	P
	8) Description of safeguards and means provided for applications with to suspend the safeguards	See instruction	P
	9) instructions on the procedures for securing the machine for safe maintenance; (see also 17.8);		P
	10) information on handling, transportation and storage;	See instruction	
	11) information regarding load currents, peak starting currents and permitted voltage drops, as	See instruction	P

EN 60204-1:2018			
Clause	Requirement-Test	Result-Remark	Verdict
	applicable;		
	12) information on the residual risks due to the protection measures adopted, indication of whether any particular training is required and specification of any necessary personal protective equipment.	See instruction	P
17.3	Requirements applicable to all documentation		
	Unless otherwise agreed between manufacturer and user:		-
	the documentation shall be in accordance with relevant parts of IEC 61082;	Comply with requirements	P
	reference designations shall be in accordance with relevant parts of IEC 61346;	Comply with requirements	P
	instructions/manuals shall be in accordance with IEC 62079.	Comply with requirements	P
	parts lists where provided shall be in accordance with IEC 62027, class B.	Comply with requirements	P
	For referencing of the different documents, the supplier shall select one of the following methods:		-
	-where the documentation consists of a small number of documents (for example less than 5) each of the documents shall carry as a cross-reference the document numbers of all other documents belonging to the electrical equipment; or		N
	-for single level main documents only (see IEC 62023), all documents shall be listed with document numbers and titles in a drawing or document list; or		P
	-all documents of a certain level (see IEC 62023) of the document structure shall be listed, with document numbers and titles, in a parts list belonging to the same level.		N
17.4	Installation documents		P
	The installation documents shall give all information necessary for the preliminary work of setting up the machine (including commissioning). In complex cases, it may be necessary to refer to the assembly drawings for details.	See instruction	P
	The recommended position, type, and cross-sectional areas of the supply cables to be installed on site shall be clearly indicated.	See instruction	P
	The data necessary for choosing the type, characteristics, rated currents, and setting of the overcurrent protective device(s) for the supply conductors to the electrical equipment of the machine shall be stated (see 7.2.2).	See instruction	P
	Where necessary, the size, purpose, and location of any ducts in the foundation that are to be provided		N

EN 60204-1:2018			
Clause	Requirement-Test	Result-Remark	Verdict
	by the user shall be detailed (see Annex B).		
	The size, type, and purpose of ducts, cable trays, or cable supports between the machine and the associated equipment that are to be provided by the user shall be detailed (see Annex B).	See instruction	P
	Where necessary, the diagram shall indicate where space is required for the removal or servicing of the electrical equipment.	See instruction	P
	In addition, where it is appropriate, an interconnection diagram or table shall be provided. That diagram or table shall give full information about all external connections.	See instruction	P
	Where the electrical equipment is intended to be operated from more than one source of electrical supply, the interconnection diagram or table shall indicate the modifications or interconnections required for the use of each supply.		N
17.5	Overview diagrams and function diagrams		P
	Where it is necessary to facilitate the understanding of the principles of operation, an overview diagram shall be provided.	See instruction	P
	An overview diagram symbolically represents the electrical equipment together with its functional interrelationships without necessarily showing all of the interconnections.	See instruction	P
	Function diagrams may be provided as either part of, or in addition to, the overview diagram.	See instruction	P
17.6	Circuit diagrams		P
	Circuit diagrams show the electrical circuits on the machine and its associated electrical equipment	See circuit diagram	P
	Any graphical symbol not shown in EN 60617 and EN 60417-1 must be separately shown and described on the wiring diagrams or supporting documents	See circuit diagram	P
	The symbols and identification of components consistent throughout all documents and on the machine	See circuit diagram	P
	Where appropriate, a diagram provided, showing the interface terminals and connections	See circuit diagram	P
	The diagram shows a reference to the detailed circuit diagram of each unit	See circuit diagram	P
	Switch symbols shown on the circuit diagrams with all supplies turned off and with the machine and its electrical equipment in normal starting condition	See circuit diagram	P

EN 60204-1:2018			
Clause	Requirement-Test	Result-Remark	Verdict
	Conductors identified acc. to cl.13.2	See circuit diagram	P
	Characteristics relating to the function of the control device and components which are not evident from their symbolic representation, included on the diagrams adjacent to the symbol or referenced to a footnote	See circuit diagram	P
17.7	Operating manual	-	
	Technical documentation containing an operating manual, outlining proper procedures for set-up and use of equipment	See instruction	P
	Particular attention given to safety measures provided and the improper methods of operation, that are anticipated	See instruction	P
	Detailed information provided on methods for equipment programming, program verification and additional safety procedures		N
17.8	Maintenance manual	-	
	Technical documentation to contain a maintenance manual, detailing proper procedures for adjustment, servicing or preventive inspection and repair	See instruction	P
	Recommendations regarding maintenance or service records are part of it	See instruction	P
	Methods for the verification of proper operation provided	See instruction	P
17.9	Parts list	-	
	The spare parts list comprises as a minimum information for ordering of spares or replacement of parts which are required for preventive or corrective maintenance and recommended spares	See part list	P
18	Verification		P
18.1	General		
	This part of IEC 60204 gives general requirements for the electrical equipment of machines.		P
	The extent of verification will be given in the dedicated product standard for a particular machine. Where there is no dedicated product standard for the machine, the verifications shall always include the items a), b) and f) and may include one or more of the items c) to e):		-
	a) verification that the electrical equipment complies with its technical documentation;		P
	b) in case of protection against indirect contact by automatic disconnection, conditions for protection		P

EN 60204-1:2018			
Clause	Requirement-Test	Result-Remark	Verdict
	by automatic disconnection shall be verified according to 18.2;		
	c) insulation resistance test (see 18.3);		P
	d) voltage test (see 18.4);		P
	e) protection against residual voltage (see 18.5);		P
	f) functional tests (see 18.6).		P
	When these tests are performed, it is recommended that they follow the sequence listed above.		P
18.2	Verification of conditions for protection by automatic disconnection of supply		P
18.2.1	General		P
	The conditions for automatic disconnection of supply (see 6.3.3) shall be verified by tests.		P
	For TN-systems, those test methods are described in 18.2.2; their application for different conditions of supply are specified in 18.2.3.		P
	For TT and IT systems, see IEC 60364-6-61.		N
18.2.2	Test methods in TN-systems		N
18.2.3	Application of the test methods for TN-systems		N
18.3	Insulation resistance tests		P
	Insulation resistance measured with 500VDC between power circuit conductors and PE-circuit is to be =1.0 M Ω	(See appended table 18.3)	P
	Insulation value must be = 1.0 M Ω	(See appended table 18.3)	P
	Test made on individual sections of complete electrical installation	(See appended table 18.3)	P
	For certain parts of the electrical equipment, a lower minimum insulation value is permitted, but not less than 50 k Ω		N
18.4	Voltage tests		P
	Test conditions : at least 1 second - test voltage is twice the rated supply voltage of the equipment or 1000 V, whichever is greater frequency of 50/60 Hz supplied from a transformer with a min. rating of 500 VA shall not breakdown	1000 V , 1min not breakdown.	P
18.5	Protection against residual voltages		N
	Tests shall be performed to ensure compliance with 6.2.4		N
18.6	Functional test		P
	The functions of electrical equipment shall be tested (particularly those related to safety and safeguarding)	(See appended table 18.6)	P
18.7	Retesting		N
	Where a portion of the machine and its associated		N

EN 60204-1:2018			
Clause	Requirement-Test	Result-Remark	Verdict
	equipment is changed or modified, that portion shall be verified and retested, as is appropriate		

18.2	TABLE: Continuity of the protective bonding circuit	P
-------------	--	----------

Location	Current(A)	Frequency(Hz)	Measured voltage(V)	Limit(V)
Between incoming PE terminal and relevant points that are part of the protective bonding circuit	10	50	0.35	1.0

18.3	TABLE: Insulation resistance tests	P
-------------	---	----------

Location	Voltage(V) d.c	Frequency(Hz)	Time(s)	Measured insulation resistance(MΩ)
Between power circuit conductors and protective bonding circuit	500	---	60	395

18.4	TABLE: Voltage tests	P
-------------	-----------------------------	----------

test voltage applied between:	Test voltage (V) a.c. / d.c.	Breakdown Yes / No
The conductors of all circuits and the protective bonding circuits	1000 a.c., 50Hz, 1min	No

18.6	TABLE: Function tests	P
-------------	------------------------------	----------

S/N	Function	requirement	Result
1	Vibration	Body \leq 0.1mm Dust cleaning \leq 0.7mm	0.09mm
2	Transmission parts checking	Suitable for intended use, no abnormal noise	OK
4	Speed variety for rotation parts moved by same bearing	$<$ 5%	2.5%
5	Guard door protection device checking	sensitive	OK
6	Completed product		OK

Annex : Technical Information

(1) Product Photos



A.1



A.2



A.3



A.4