

Online Turbidity Meter

Model : TBG-2088S/P User Manual



SHANGHAI BOQU INSTRUMENT CO.,LTD

Address:No. 118 Xiuyan Road,Pudong New Area,Shanghai,zip code:201315,China

Email: michael@shboqu.com | Mob:86-15000087545 | web:www.boquinstrument.com



Catalogue

- 1.Introduction3**
 - 1.Introduction3
 - 1.2 Technical Features 3
 - 1.3 Application4
 - 1.4 Technical parameters 5
- 2.Appearance and structure6**
 - 2.1Appearance6
 - 2.2 Inner structure 6
- 3. Installation and Wiring..... 7**
 - 3.1Installation requirements 7
 - 3.2 Wiring 8
- 4.Operation 8**
 - 4.1 Operation Interface 8
 - 4.2 Measurement interface 9
 - 4.3 Setting 10
 - 4.4 Unit 11
 - 4.5 4-20mA 11
 - 4.6 ModbusRTU communication 12
 - 4.7 Simulation 12
 - 4.8 Relay Set 13
 - 4.9 Auto Sewage 13
 - 4.10 Storage 14
 - 4.11 Date&Time 14
 - 4.12 Language 15
 - 4.13Backlight 15
 - 4.14 Factory data reset 15
 - 4.15 Calibration 16
 - 4.16 Factory reset 17
 - 4.17 History Data Display 17
 - 4.18 Waveform Display 18
- 5.Common faults and handling18**
- 6.Attention 20**
- 7. MODBUS Protocol.....21**

1.Introduction

1.Introduction

TBG-2088S/P online turbidity analyzer integrates flow through type turbidity sensor, intelligent online turbidity analyzer and waterway into a complete machine, which can view and manage data on the turbidity analyzer, perform calibration and other operations; this system It integrates the functions of online analysis of water turbidity, remote data transmission, database and calibration, which provides great convenience for the collection and analysis of water turbidity data.

The turbidity sensor part has its own defoaming tank, which can make the water sample enter the turbidity measuring tank after defoaming. The instrument requires less water samples and has strong real-time performance. A small water sample flows through the defoaming tank and enters the measuring tank, and the water sample is always kept in circulation. When the water sample passes through the circulation device, the instrument collects the turbidity of the water sample, and can also be connected to the central control room or the upper computer through digital communication.

1.2 Technical Features

- ◆ With precision digital turbidity sensor, Plug and use.
- ◆ Classic flow cell design with Bubble rejection system.
- ◆ Wide power supply: 85VAC ~ 265VAC.
- ◆ Automatic drain function, few manual maintenance
- ◆ Two ways of 4-20mA, one for Turbidity ,another for temperature.
- ◆ With 3 relays: 2 relays for high & low point, another for clean set.
- ◆ Standard RS485 Modbus for PLC, Wireless, or other platform.
- ◆ Local data recording function and History data curve.

- ◆ Anti-electromagnetic interference and Surge protection.
- ◆ Power-off protection function, save measurement data completely.

1.3 Application

- ◆ Online continuous turbidity monitoring of clean water :
- ◆ Boiler water turbidity measurement
- ◆ Swimming pool clarity monitoring
- ◆ Food / drink water turbidity
- ◆ Potable water quality
- ◆ Process liquids monitoring
- ◆ Treated process water
- ◆ Pipe network
- ◆ secondary water supply etc.

1.4 Technical parameters

| Model | | TBG-2088S/P |
|---------------------------|--------------------------------------|--|
| Measurement configuration | | Turbidity/Temperature |
| Range | Temperature | 0-60°C |
| | Turbidity | 0-20NTU,0~100NTU |
| Resolution & Accuracy | Temperature | Resolution:0.1°C ; Accuracy:±0.5°C |
| | Turbidity | Resolution:0.01NTU; Accuracy:±2% FS |
| Communication Interface | 4-20mA /RS485 | |
| Power supply | AC 85-265V | |
| Water flow | < 300mL/min | |
| Working Environment | Temp:0-50°C | |
| Total power | 30W | |
| Inlet | 6mm | |
| Outlet | 16mm | |
| Protection | IP65 | |
| Wireless | Optional(for Mobile App and Website) | |
| Cabinet size | 600mm×400mm×230mm (L×W×H) | |

2.Appearance and structure

2.1 Appearance

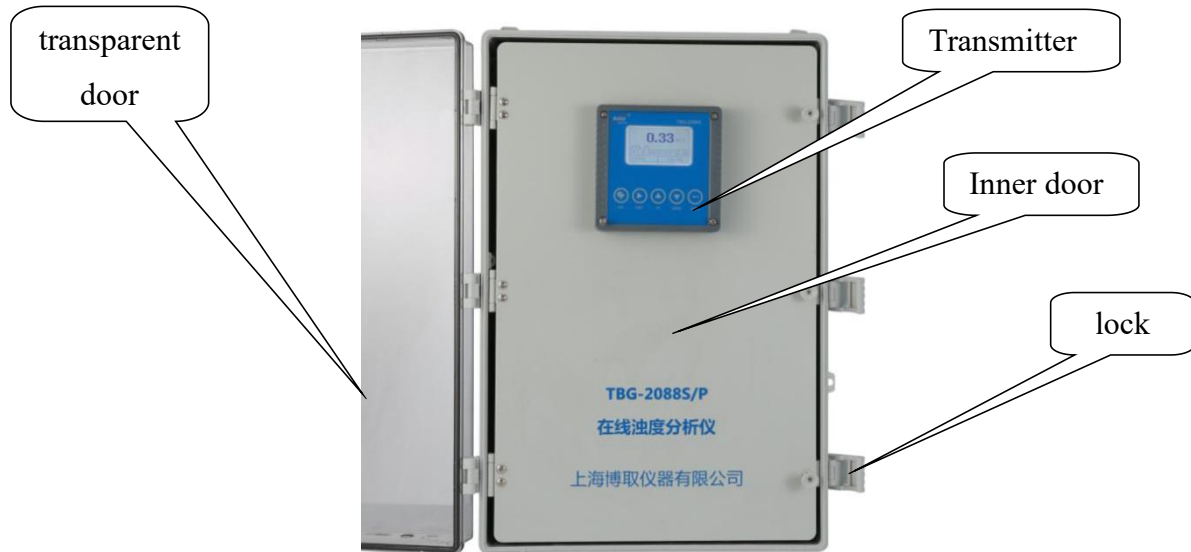

Turbidity analyzer: real-time display of measurement data, and operations such as setting and calibration can be performed by pressing keys

2.2 Inner structure

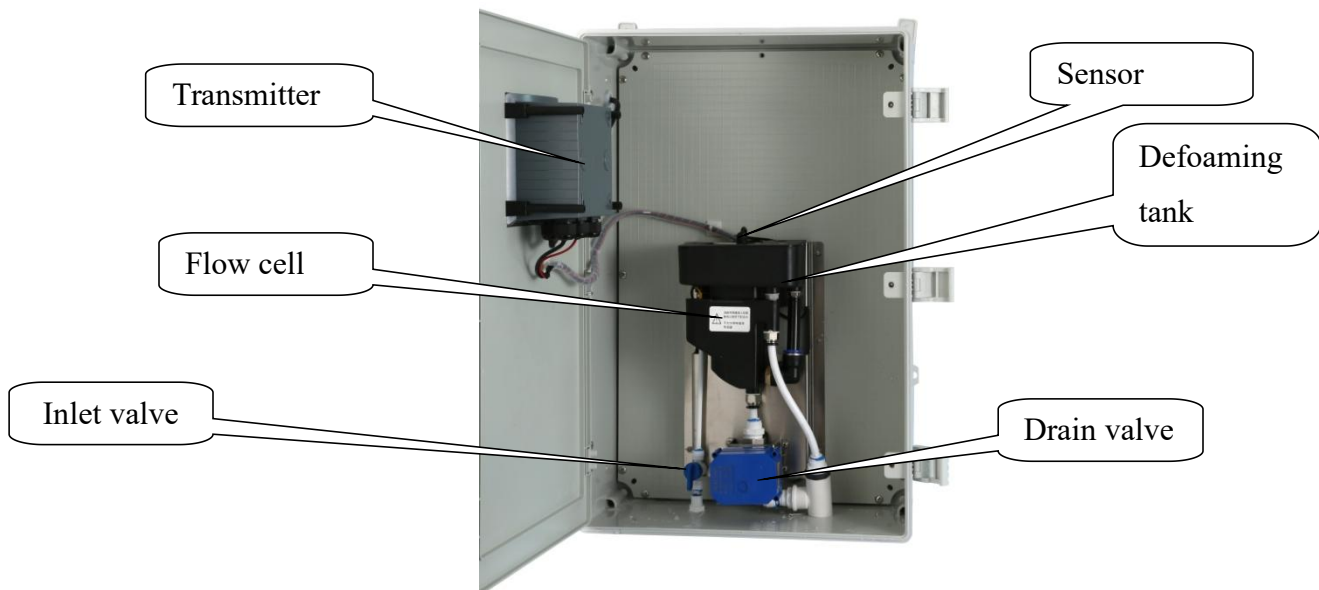

The instrument is equipped with: digital turbidity electrode, turbidity analyzer, defoaming pool, measuring pool and waterway, etc. The internal wiring of the instrument is connected and the sensor is installed. The power line and communication

output line of the instrument are on the upper left side of the instrument, and the inlet and outlet pipes are on the bottom side of the instrument. Before use, customers only need to plug in the power cord and connect the inlet and outlet pipes.

3. Installation and Wiring

3.1 Installation requirements

- (1) Select the installation location of the instrument in a spacious, ventilated and dry indoor environment
- (2) The instrument should be placed and fixed at a position slightly higher than the drainage water level (300mm above the ground level is the most suitable height) to facilitate smooth drainage.
- (3) There should be enough space for personnel to operate around the instrument to facilitate later maintenance and calibration.
- (4) The level of the instrument's drainage pipe layout should be lower than the level of the water outlet of the instrument, and the total length of the water outlet pipe should not exceed 3 meters, and there should be no blockage at the end.
- (5) The water inlet and outlet pipes of the instrument all use quick-plug joints, and the water inlet pipes have matching adapters. The user can match other adapters according to the actual situation on site, but the final pipeline connected to the water inlet of the instrument cannot be changed.
- (6) Water pressure: ≤ 0.3 Mpa
- (7) Flow requirements: ≤ 300 mL/min
- (8) Anti-interference preventive measures: Do not share a power supply with motors, inverters and other high-power equipment.
- (9) Water and electricity measurement.
- (10) After the instrument is powered on, open the water inlet valve, and the water sample enters the flow cell. After the water level in the flow cell reaches a certain height, the water sample flows out from the drain.

3.2 Wiring

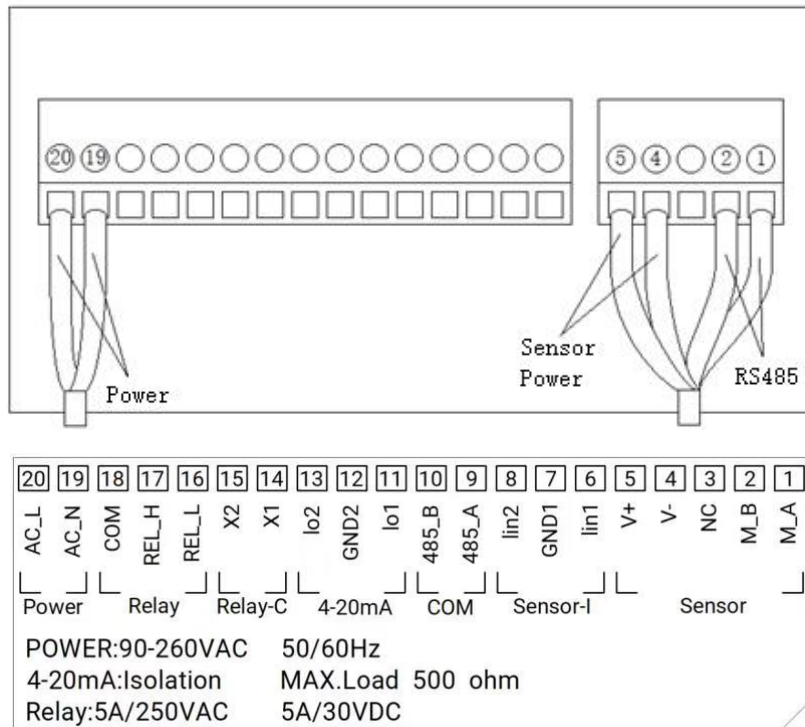

4.Operation

4.1 Operation Interface

There are 2 modules in the main panel of the turbidity measuring instrument, LED LCD display module and button module.

Users can set and adjust the parameters of the instrument through the 5 buttons on the panel.

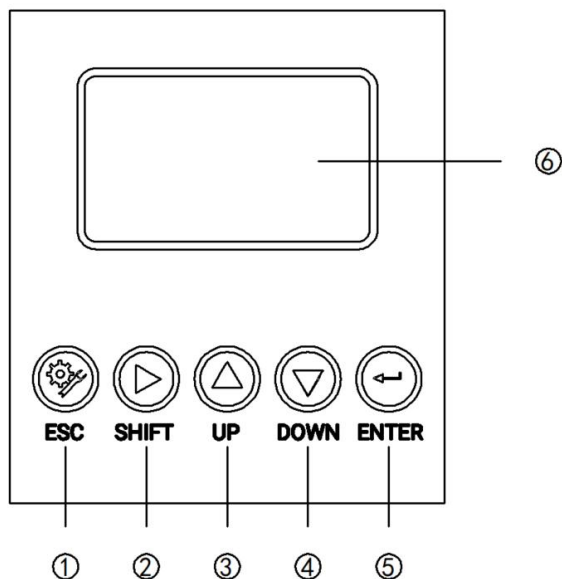

Operation Interface

- ① Set/Exit button
- ② Select/Shift button
- ③ Up button
- ④ Down button
- ⑤ Confirm button
- ⑥ LED screen

4.2 Measurement interface

Enter the main measurement interface after the start-up animation.

When the instrument is working normally, the LED display shows the following content.

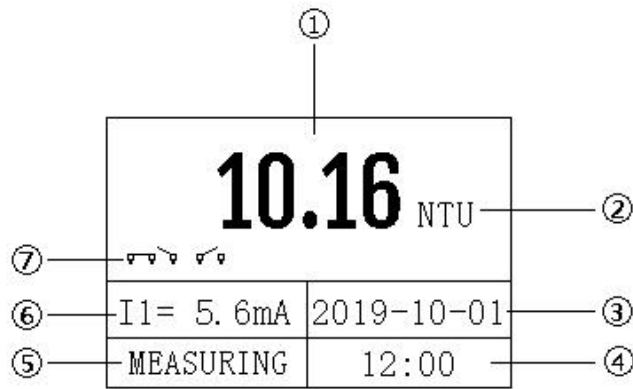

Main interface

- ① Measurement value
- ② Unit
- ③ Real-time date
- ④ Real time
- ⑤ Measurement status
- ⑥ 4-20mA corresponding value of turbidity
- ⑦ Relay status

4.3 Setting

Press “Set/Exit Button” to enter the password input interface.

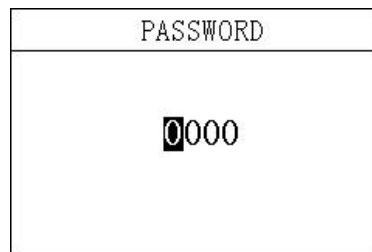

Picture 5 Password

Enter settings:

Enter the password "3700" to enter the setup menu.

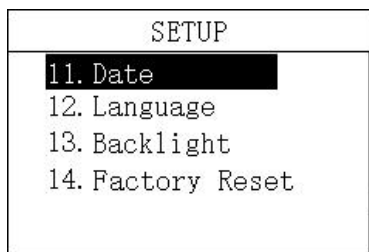
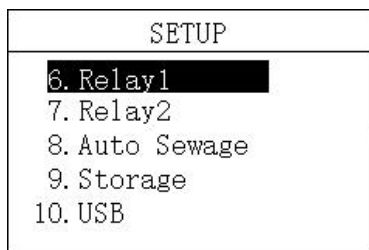
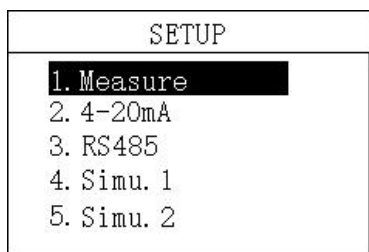

4.4 Unit

In this menu, users can change the measurement method NTU/FTU, and at the same time can adjust the offset to make the measurement accurate.

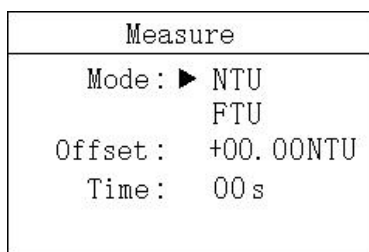

4.5 4-20mA

In this menu, users can change the corresponding value of 4-20mA and set the corresponding effective range.

| |
|-------------------|
| 4-20mA |
| 4mA : 0000.0 NTU |
| 20mA : 0100.0 NTU |

4.6 ModbusRTU communication

In this menu, users can change the communication address and rate.

| |
|------------------|
| Modbus RTU |
| Address : 004 |
| B. R. : 4800 bps |
| ▶ 9600 bps |
| 19200 bps |

4.7 Simulation

In this menu, users can simulate the 4-20mA current output. The current output can be verified by simulating the measurement of the IO1 (measured value) and IO2 (temperature) ports. The release relay is closed. The relay is simulated and verified.

| |
|-------------------|
| Simulation1 |
| Current1: 04.00mA |
| Relay1: ON |
| ▶ OFF |
| Humidity: 0.0 |

Simulation1

| |
|-------------|
| Simulation2 |
| Relay2 : ON |
| ▶ OFF |
| Relay3 : ON |
| ▶ OFF |

Simulation2

4.8 Relay Set

Relay1

In this menu, users can switch the relay 1 function, set the parameter alarm upper limit value, alarm return difference value, and alarm delay time.

| Relay1 | |
|---------|-------------|
| Func. : | ON ▶ OFF |
| High : | 0100.00NTU |
| Hyst. : | 0010.00NTU |
| Delay : | 030 S |

Relay2

In this menu, users can switch the relay 2 function, set the parameter alarm lower limit value, alarm return difference value, and alarm delay time.

| Relay2 | |
|---------|-------------|
| Func. : | ON ▶ OFF |
| Low : | 0010.00NTU |
| Hyst : | 0001.00NTU |
| Delay : | 030 S |

Relay3(Immersion only)

In this menu, users can set the relay 3 function, set the cleaning time and cleaning cycle.

| Relay3 | |
|---------|-------------|
| Func. : | ON ▶ OFF |
| Period: | 001.0h |
| Clean: | 010s |

4.9 Auto Sewage

In this menu, users can switch the automatic drainage function (default on), set the drainage cycle (the shortest cycle is 1 day, the longest cycle is 30 days, if the setting exceeds 30 days, it will automatically change to 10 days) and manually perform a sewage discharge .

| | |
|-------------|-----------------|
| Auto Sewage | |
| Func. : | ON ▶ OFF |
| Period : | 01 Day Clean |

Auto Sewage

The duration of each sewage discharge is 3 minutes (cannot be changed), which will be displayed in the main interface, during which the measurement will be suspended.

| | |
|------------------|------------|
| 10.16 NTU | |
| 167s | |
| I1= 5.6mA | 2019-10-01 |
| Cleaning | 12:00 |

Auto Sewage display

4.10 Storage

In this menu, users can set the storage function (default off), clear storage memory and recording interval.

| | |
|------------|-------------|
| Storage | |
| Switch : | ON ▶ OFF |
| Clear : | YES ▶ NO |
| Interval : | 005 min |

Storage

4.11 Date&Time

In this menu, users can change date and time according to different time zone.

| |
|--------------------|
| Date |
| Y-M-D : 2019-10-01 |
| H:M:S : 12:00:00 |

Date&Time

4.12 Language

Users can choose English or Chinese according to need.

| |
|------------------|
| Language |
| Language: ▶ 简体中文 |
| English |

Language

4.13 Backlight

In this menu, users can change the backlight mode of the LCD screen. The backlight can be always on or delayed off (the default is delayed off), the backlight brightness can be changed (brightness level 1-5, brightness increases), and the contrast can be changed.

| |
|-------------|
| Backlight |
| Func.: ▶ ON |
| Delay 30S |
| Bright: 3 |
| Contrast: 2 |

Backlight

4.14 Factory data reset

In this menu, users can restore the current output and relay to the factory parameters.

| |
|--|
| Factory Reset |
| Restore : ▶ Current Relay1 Relay2 Relay3 All |

Factory data reset

4.15 Calibration

Press “Set/Exit Button” to enter the password input interface.

| |
|----------|
| PASSWORD |
| 0000 |

Password

Enter calibration:

Enter the password "3900" to enter the calibration menu.

| |
|--|
| CALIBRATION |
| 1. One Point Cal 2. Two Point Cal 3. Factory set |

One Point Calibration

Add a solution of known concentration, when the measured value on the left is stable, modify the value on the right to the concentration of the solution and press the enter key.

| | |
|---------------------|------------------------|
| One Point Cal | |
| 0.342 NTU | 0.000 NTU (≤20) NTU |
| Wait... Press Enter | |

One Point Calibration

Two Point Calibration

The method is the same as one point calibration, adding solutions with different concentrations (the concentration of the solution used at the first point must be less than the second point).

| Two Point Cal 1 | | Two Point Cal 2 | |
|---------------------|-------------------------|---------------------|-------------------------|
| 0.342 NTU | 10.000 NTU (≤20) NTU | 10.342 NTU | 14.000 NTU (≥ 1) NTU |
| Wait... Press Enter | | Wait... Press Enter | |

4.16 Factory reset

In this menu, users can restore the calibration parameters to the factory parameters.

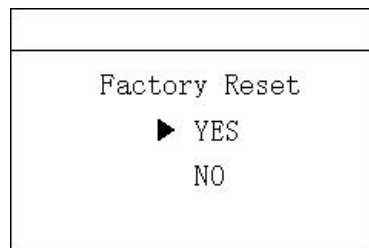

Factory set

4.17 History Data Display

Press "ESC" to enter the password input interface.

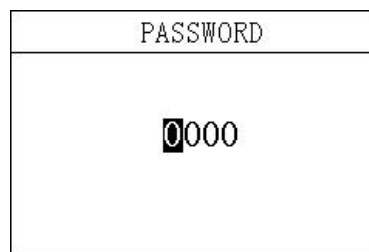

Password

Enter History Data Display:

Enter the password "1300" to enter the History Data Display.

Press the up and down keys to switch the display. It can store up to 1000 records and

overwrite automatically if reach maximum.

| | |
|---------------------|----------|
| Record | 1/1000 |
| 2020-01-09 12:48:28 | 6.00 NTU |
| 2020-01-09 12:43:28 | 6.00 NTU |
| 2020-01-09 12:38:28 | 6.00 NTU |
| 2020-01-09 12:33:28 | 6.00 NTU |

History

4.18 Waveform Display

Press "ESC" to enter the password input interface.

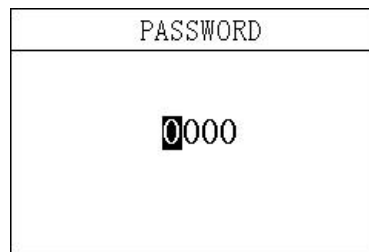

Picture 13 Password

Enter Waveform Display:

Enter the password "1400" to enter the Waveform Display.

Press the up and down keys to switch the display.

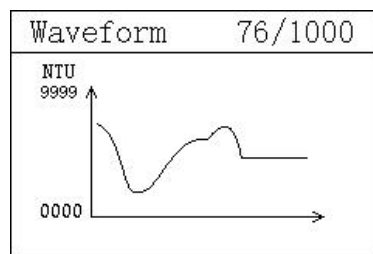

Waveform Display

5.Common faults and handling

| NO. | Fault | Approach |
|-----|------------|-----------------------|
| 1 | No display | Check power on or off |

| | | |
|---|--|--|
| | | Check power wire connection |
| 2 | The instrument shows that the sensor cannot be found | Check sensor wire |
| 3 | Big measurement error | <p>Check whether the measured water sample has obvious changes, including relevant conditions such as water quality and flow rate. If there is any abnormality, please use a portable or laboratory instrument for comparison.</p> <p>Check whether there is any water sample in the measuring cell, and it circulates normally.</p> <p>Check that the blowdown valve is closed.</p> |
| 4 | There is water coming out of the lid of the defoaming tank | Check whether the inlet water flow is too large, and adjust the opening of the inlet valve to reduce the inlet water flow rate. |
| 5 | The overflow port of the measuring cell is not flowing smoothly or some joints are leaking | <p>Check whether the water outlet is blocked by foreign objects and whether the drainage pipeline is unobstructed.</p> <p>Check whether the water outlet pipe outside the box is too high, resulting in poor drainage.</p> |

6.Attention

When using it for the first time, hang the instrument securely, connect the inlet and outlet pipes, and then turn on the power.

If the instrument needs to be transported or transported, close the water inlet valve before powering off the instrument, enter the automatic blowdown setting interface of the turbidity analyzer setting menu, select manual blowdown once, open the blowdown solenoid valve, and drain the water sample in the sensor measuring cell. Empty, to avoid the liquid leaking to the outside during the handling or transportation of the instrument, which may cause the electronic parts to get wet.

If the instrument is not used for a long time, it is also recommended to manually empty the water sample in the measuring cell to prevent the water sample from remaining for a long time and scaling on the inner wall of the measuring cell.

7. MODBUS Protocol

Communication protocol

Communication parameters:

Baudrate: 4800, 9600, 19200 (9600 default)

Serial data format: 8N1 (8 data bits, No parity, 1 stop bit)

Function code: 03

Device address: Turbidity analyzer defaults to 4

Register definition:

| Register address(Dec) | Definition | R/W | Remarks |
|-----------------------|-------------|-----|--|
| 2,3 | Turbidity | R | ×1 NTU, FP32 AB CD |
| 8 | RTU Address | R/W | Modbus communication address, TB defaults 4. |
| 9 | Baudrate | R/W | 4800, 9600, 19200, 9600 as default |

Examples of communication formats:

Data reading instruction

Addr. + Func. + Register start address + Number of Registers read + CRC check code (Hex)

e.g. Tx: 04 03 00 02 00 02 65 9E

| Address | Func. | Register start address | Number of Registers read | CRC check code |
|---------|-------|------------------------|--------------------------|----------------|
| 04 | 03 | 0002 | 0002 | 659E |

Data return instruction:

Address + Func. + Data length + Data + CRC check code (Hex)

e.g. Rx: 04 03 04 40 0E B8 52 28 CD

| Address | Func. | Data length | TB value | CRC check code |
|---------|-------|-------------|----------|----------------|
| 04 | 03 | 04 | 400EB852 | 28CD |

The transmission data format is FP32 AB CD, the conversion sequence is 400EB852. Convert the hexadecimal number 400EB852 to decimal through a floating-point number converter, resulting in a value of 2.23

| | |
|------------|---|
| HEX To DEC | |
| HEX : | <input type="text" value="400EB852"/> |
| | <input type="text" value="\$40\$0E\$B8\$52"/> |
| DEC : | <input type="text" value="2.23000001907349"/> |

Shanghai BOQU instrument Co.,Ltd.

Tel: 86-021-20922782

Fax: 86-021-20981909

Mob: 86-15000087545

Postcode: 201315

Website: www.boquinstrument.com

E-mail: michael@shboqu.com

Address: No.118 Xiuyan Road, Pudong New District, Shanghai

30200099