

用户手册
User Manual

AC 系列空调器

AC Series Air Conditioner

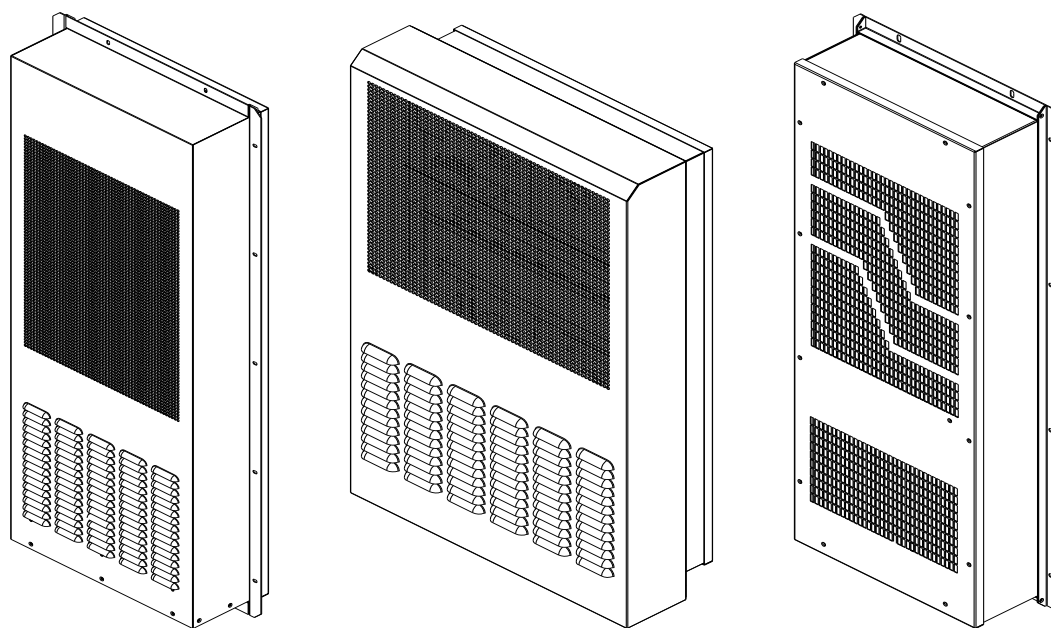

在产品安装使用前请仔细阅读本手册
Reading this manual carefully before installation and using

前言 Foreword

本手册介绍了 AC 系列空调的使用须知、产品接线、操作指导、日常维护等信息。

本手册主要用来指导用户进行安装，维护本系列空调产品。

针对本系列产品的任何操作必须由专业的技术人员根据本手册的要求进行。

The manual describes a series of AC air conditioners' instructions, wiring, operating instructions.

The manual is mainly used to guide users to install and maintain the series of air conditioners.

For the series of products of any operation must be made by the professional technicians according to the requirements of the manual.

变更记录 **Change History**

版本//Version	文件历史 // Change History	日期 // Date
A	创建 // Created	2023.4.20
B	更新维保内容// Update maintenance content	2026-03-24

目录 CONTENTS

前言 FOREWORD	2
变更记录 CHANGE HISTORY	3
声明 DECLARATION	5
1. 简介	6
1.1 产品描述 PRODUCT DESCRIPTION	6
1.2 符合标准 CONFORM TO THE STANDARD	6
2. 包装与运输 PACKING AND SHIPPING	7
3. 开箱与验收 UNPACKING AND ACCEPTANCE	8
4. 安装 INSTALLATION	8
4.1 安装前准备 BEFORE INSTALLATION	8
4.2 安装示意 SCHEMATIC OF INSTALLATION	8
4.3 空调器安装 AIR CONDITIONER INSTALLATION	9
4.4 电气布线 ELECTRICAL WIRING	10
5. 运行逻辑 OPERATION LOGIC	11
5.1、开机运行 RUNNING	11
5.2、控制逻辑 CONTROL LOGIC	12
5.3、手操器使用说明 INSTRUCTIONS OF DISPLAY PANEL	13
5.4、告警与故障 ALARM AND FAULT	15
5.5、其他故障分析与处理 OTHER FAULT ANALYSIS AND PROCESSING	16
6. 产品维护 MAINTENANCE	17
7. 产品质保 WARRANTY	19
8. 回收处理 RECLAIM	21

声明 Declaration

RoHS Compliance Declaration of Cabinet AC air conditioner

European Guidelines 2011/65/EU (RoHS)

Legal regulation for Substances

Dear Sir/Madam,

Referring to the European guideline of 2011/65/EU, we confirmed that according to the current status of our knowledge and in accordance with the regulations, we could produce products complying with above mentioned guidelines especially for below type:

A 0** / E / A / H**

1. 简介

1.1 产品描述 Product description

该系列产品是针对通讯或相关工业设备应用场合而设计的高性能交流型空调器，适用于机柜内部设备发热量大、温度敏感，且内外完全隔离的应用场合：

电网适用范围：交流 AC220~240V±10% 50Hz

注意：在运输、储存以及使用过程中，必须严格按照包装上的指示保持空调竖直向上放置；

This series of products are designed for communication or related industrial equipment applications of high-performance ac type air conditioning unit, cabinet internal devices suitable for heat, temperature sensitive, and inside and outside completely isolated applications;

Grid application scope: AC220~240V±10% 50Hz

Other power supply system, please refer to the nameplate

Warning: In the process of transportation, storage and use, must be in strict accordance with the instructions on the package to keep air conditioning placed vertically upward.

1.2 符合标准 Conform to the standard

Standard	Description
GB/T 17626.7-1998	Electromagnetic compatibility(EMC)
GB4706.1	Safety household and similar electrical appliance
GB4798.1	Environmental conditions existing in the application of electric and electronic products - storage
GB4798.2	Environmental conditions existing in the application of electric and electronic products - transport
GB4798.3	Environmental conditions existing in the application of electric and electronic products - use
CE	Self certification

2. 包装与运输 Packing and Shipping

- 空调采用纸箱包装，附件等资料也放置于包装箱内。

Air conditioner packed in paper cases ,the package includes Annex.

- 空调在运输时请注意以下事项：

The air conditioner during the transportation, please pay attention to the following matters

Warning

图 2-1 包装箱标识

Figure2-1 Packing mark

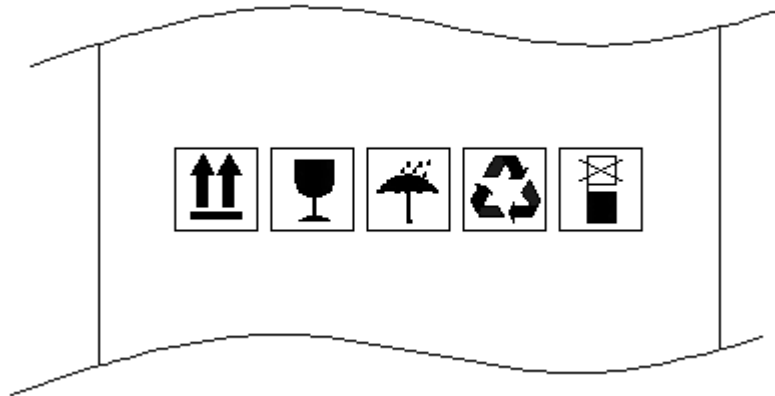

- 搬运或者运输过程中空调必须按  朝上放置。严禁倒置、平放、过度倾斜及碰撞。

During Handling or transport, Air conditioner must be upward placed as  No inverted, flat,

excessive tilt and collision.

- 空调为精密仪器，在搬运或者运输过程中，应小心轻放，包装箱上禁止踩踏，禁止站立或放置其他重物。

Air conditioner is precision instrument, in handling or transport process, should be handled with care, package boxes do not step, prohibit standing or placing other heavy objects.

- 搬运或运输过程中，注意防潮、防水、防雨。

During Handling or transporting, pay attention to moisture, water, rain

3. 开箱与验收 Unpacking and Acceptance

- 开箱前请注意外包装箱按照图 2-1 所示直立放置，请检查打包带是否断裂、木箱是否破损、变形、潮湿。

Make sure the package upright as shown in Figure 4-1 before you open the package, please check the packing belt is broken; the wooden box is damaged, deformed, wet.

- 使用剪刀或者小刀拆除打包带，将包装木箱拆除。
Use scissors or a knife dismantling packing belt, and then open the wooden box.
- 打开包装后，请按照装箱清单核对产品
After opening the package, please check the products according to the packing list.

4. 安装 Installation

4.1 安装前准备 Before Installation

安装前至少需准备以下工具：十字螺丝刀、一字螺丝刀、密封条、老虎钳。

You have to prepare the following tools before installation: cross screwdriver, slot type screwdriver, sealing strip, vice.

4.2 安装示意 Schematic of Installation

空调的安装示意图如下：

Air Conditioner schematic of installation as follow:

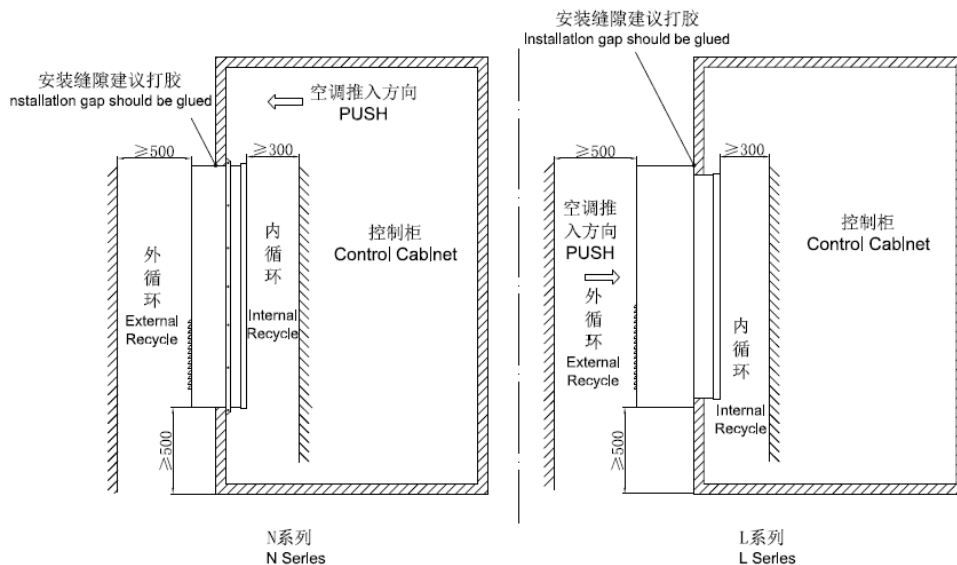

- a) 防护罩进风口和出风口开孔率应大于 60%，以确保足够的循环风量，这对于延长空调的使用寿命和减少维护频率非常的重要；
- b) 防护罩的进出风口应该防止气流短路,以便空调可以获得最佳的冷却效果。

Attention:

- a) Shield inlet and outlet opening rate should be greater than 60%, In order to ensure enough circulation air volume. This is very important to have the air conditioner running with long lifetime and less service;
- b) When you make a cowling design/installation, make sure the inlet air and outlet air not been short cut, this is also critical to keep unit have best cooling performance.

4.3 空调器安装 Air Conditioner Installation

➤ 安装步骤:

1. 在安装面上画出柜门开孔示意图，将阴影部分切割掉。不同型号空调的柜门开孔示意图请参考相应规格书；
2. 根据安装示意图中示意的方向，将空调安装在机柜上；
3. 如果需要安装水管，请将水管安装在底部接水管处并用管箍固定。

➤ Installation steps:

1. Draw on the cabinet mounting cut-out map according to Figure, cut off the shadow part. Different models of air conditioner cabinet mounting cut-out maps refer to its specification.
2. According to the direction of the schematic of installation, installed the air conditioner on the cabinet.
3. Please to install drain pipe on drain hole and fix with pipe hoop if you need.

➤ 安装完成后的确认检验项:

1. 请勿在高油污、易燃气体、高腐蚀性及环境温度超过 55℃、湿度超过 95%的环境下使用该产品；
2. 确保产品安装后倾斜度不大于 3°；
3. 确保控制柜密封良好以免漏入空气产生不必要的冷量损失和产生过多的冷凝水；
4. 产品安装结束后，确保产品直立 30 分钟后再加电运行。

- Double check lists after Installation:
 1. Don't apply this unit in high oil, burning gas, explosive gas, strong corrosively condition, the ambient air must be under 55°C, and the humidity not higher than 95%.
 2. Make sure that the lean of the product no more than 3°.
 3. Make sure that the cabinet should be sealed well to avoid the cooling losing and avoid ambient moisture penetrate into cabinet, this will avoid produce more condensate water.
 4. Ensure that the product is up and running in upright 30 minutes.

4.4 电气布线 Electrical Wiring

空调器在使用前需根据本手册的说明进行电气连接，建议客户优先使用附件中的线缆。客户可以自备线缆，如果客户不能确定所选电缆规格是否合适，可联系售后服务部门。

Does Electrical Wiring according to the manual before use the air conditioner; we suggested preferring to use cables in the attachments. You should call the After-sale Service Department, if you cannot sure the cable specification be made by your-self.

图 4-1 电源端子示意图

Figure6-1 Schematic of power terminal



表 4-1 接线端子说明 Table4-1 Terminal instructions

序号 / Number	符号 / Symble	定义 / Definition	描述 / Description
A	L(L1)	交流电源火线 Live line of AC power	/
B	N(L2)	交流电源零线 Neutral line of AC power	/
C	PE	交流电源地线 Ground wire of AC power	/
1	Control In	外部控制输入端口 External signal input port	接受外部控制信号来控制空调。 Accept external control signal to control the air conditioner.
2			
3	TR/+	RS485通讯正极 Positive pole of 485 communication	/
4	TR/-	RS485通讯负极 Negative pole of 485 communication	/
5	Alarm Out	干接点告警常闭端口 Normal close port of dry contract alarm output	/
6			
7	/		/
8			
9			
10			

5. 运行逻辑 Operation Logic

5.1、开机运行 Running

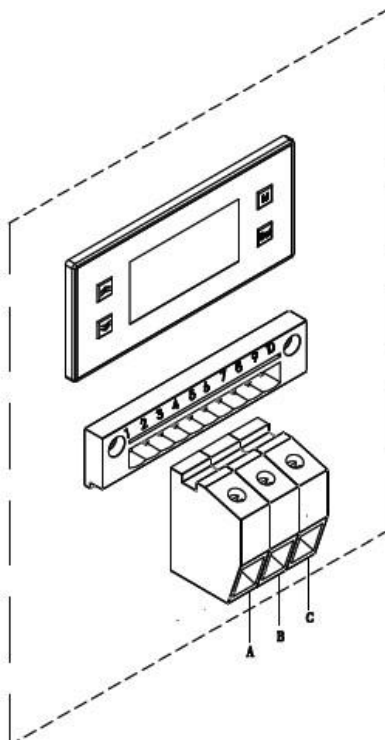
接线完成并确认接线正确后，此时可接通交流电源使空调首次上电运行。

空调上电后，首先执行自检程序，依次对内风机、温度传感器、加热器、外风机、压缩机进行检验。

自检过程中若发现故障则显示相应故障告警并进入告警状态。

Completed and confirmed the wiring correct, then you can connected to the AC power to air conditioner for the first time to run on electricity.

After power on air conditioner, first of all it will be self-checking: internal fan, temperature sensor, heater, external fan, and compressor.

Warning

空调上电运行过程中，若发生异常噪音、震动，请立即切断电源，并通知专业人士进行检查。

When the air conditioner is running, if there is abnormal noise, vibration, please cut off power immediately and notify the professionals to inspect.

5.2、控制逻辑 Control Logic

运行模式：待机模式、制冷模式、加热模式、告警模式。

Operational mode: standby, cooling, heating, and alarming.



➤ 待机模式



若回风温度 < 压缩机启动设置温度，则空调处于待机模式，此时只运行内风机，显示器显示当前回风温度。

➤ Standby mode



If the return air temperature is lower than the default set point of Compressor start temperature, the air conditioner is in a standby mode. At this time, the internal fan is running only, the monitor displays the current return air temperature.



➤ 制冷模式

若回风温度 ≥ 压缩机启动设置温度，则空调进入制冷模式。外风机先运行，显示器上  标志亮。外风机运行 60 秒后，压缩机启动， 标志亮。压缩机一旦启动，最小运行时间不小于设定值（默认为 5 分钟）。

若回风温度 ≤ 压缩机启动设置温度 - 压缩机运行回差值，且压缩机持续运行时间 ≥ 最小运行时间（默认 5 分钟），则系统停止制冷。此时压缩机先关闭， 熄灭。外风机滞后一段时间再关闭， 熄灭。

➤ Cooling mode

If the return air temperature is greater than or equal to the default set point of compressor start temperature, the air conditioner enters the cooling mode. The external fan is running, the monitor display  symbol. The compressor is running after external fan 60 seconds, the  symbol is bright. If the compressor is running, the minimum running time is less than the set time (default time is 5 minutes).

If the return air temperature is less than or equal to the default set point of compressor start temperature subtracts compressor stop hysteresis temperature, and the compressor running time is more than or equal to the minimum set time (the default time is 5 minutes), then the compressor stopped. The  symbol is extinguished. The external fan stopped after a while, and the  symbol extinguished.

➤ 加热模式

若回风温度 ≤ 加热器设置温度 - 加热器运行回差温度，则加热器开启，对系统进行加热，此时  亮。

若回风温度 ≥ 加热器设置温度 + 加热器运行回差温度，则加热停止， 熄灭。

注：加热功能只适用于带加热器机型。

➤ Heating mode

If return air temperature is less than or equal to heater start temperature subtracts heater stop hysteresis temperature, the heater runs to heat the system and the ☀ symbol bright.

If the return air temperature is greater than or equal to heater start temperature plus heater stop hysteresis temperature, the heater is stopped and the ☀ symbol extinguished.

Attention: The heating function is only applicable to models with heater.

5.3、手操器使用说明 Instructions of Display Panel

在正常情况下，手操器显示柜内温度，告警时显示告警代码；

手操器底部为状态栏，不同的指示灯代表不同状态；

通过手操器可查看空调器各项参数及对各参数进行设置（用户参数）。

The display panel shows cabinet temperature under normal circumstance, and shows alarm code when there is a malfunction.

In the bottom is the status bar, different lamp represents different status.

You can check and set various parameters of air conditioner by the display panel (User Parameters).

图 5-1 手操器示意图

Figure 5-1 the display panel diagram







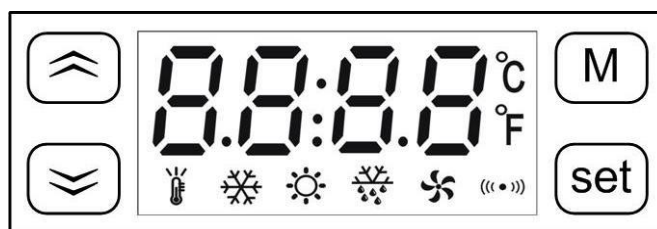

表 5-1 手操器指示灯含义

Table 5-1 the meanings of lamps on the display panel

指示灯 // lamps	描述 // Description
	闪烁表示空调处于自检或温度设置状态 Flashing when self diagnose or temperature setting mode

	闪烁表示空调即将进行制冷，常亮表示空调正在进行制冷 Lamp on when cooling
	常亮表示空调正在进行制热 Lamp on when heating
	常亮表示空调正在进行除湿 Lamp on when dehumidification
	常亮表示外风机正在运行 Lamp on when external fan is running
	闪烁表示有告警发生 Flashing when alarm

注：空调出厂时已经进行过参数设置，默认参数请参考表 5-2；部分参数需要密码才能设置，请联系客服。

Attention: Air conditioner has been setting parameters, the default parameters refer to table 5-2; Part of the parameters need to password, please contact our customer service.

➤ 参数设置：Parameter setting

长按“M”键 5 秒，进入参数设置状态，显示参数代码，用“▲▼”键选择参数代码，选择一个代码后按“Set”键则显示该代码对应的参数值，这时再用“▲▼”键即可对参数值进行设置，设置完成后再按“Set”键，回到显示参数代码状态。在显示参数时按“M”键可退出参数设置状态，在设置参数值过程中按“M”键表示放弃，退出但不改变参数值。

➤ Long press "M" key for 5 seconds, enter the parameter setting mode, then display the code of parameters, with "▲▼" key to select the code of parameters, select a code and press "Set" button will display corresponding parameter values of the code, then re-use "▲▼" button can set the parameters, after finished the setting, press "Set" button, back to display states. During the setting mode, Press "M" key to exit the parameter setting mode, in the process of the parameter values setting by pressing "M" button that give up, quit, but does not change the parameter value.

➤ Fig.5.2 User parameter 用户参数

➤ 用户参数 User parameters:

用户参数如下：The user parameters are as follows:

表 5-2 用户参数 Table 5-2 User parameter

代码 Code	参数名称 Parameter name	默认值 Default Value	范围 Range	单位 Unit	备注 Remarks
F01	压缩机启动温度 Compressor start temperature	28	20~50	℃	
F02	压缩机运行回差值 Compressor return difference	5	2~10	℃	
F09	加热器启动温度 Heater start temperature	10	-10~15	℃	
F10	加热器运行回差 Run the heater hysteresis	5	2~10	℃	
F17	高温告警温度 High temperature alarm	55	30~70	℃	
F18	低温告警温度 Low temperature alarm	-5	-42~15	℃	
F31	通讯地址 Communication address setting	1	1~255	/	
F33	除湿开启湿度 Dehumidify start Value	70	50-100	%	
F34	除湿停止回差 Dehumidify hysteresis	10	5-25	%	

5.4、告警与故障 Alarm and Fault

显示器正常时显示回风温度值，告警时交替显示回风温度和告警代码，告警代码定义如下表：

The monitor displays return air temperature at normal, If the alarms, temperature and alarm codes are displayed alternately, the alarm code as follows:

表 5-3 故障代码

Table 5-3 Alarm Code

告警代码 Alarm code	含义 Signification
E01	回风温度传感器故障 Return air temperature sensor fault
E02	冷凝盘管温度传感器故障 Condensing coil temperature sensor fault

E04	湿度温度传感器故障 Humidity-temperature sensor alarm
E09	内风机故障告警 Internal fan alarm
E10	冷凝高温告警 Condensor high temperature alarm
E11	系统高压力告警 System high pressure alarm
E13	柜内高温告警 Cabinet high temperature alarm
E14	柜内低温告警 Cabinet high temperature alarm
E22	蒸发传感器故障告警 Evaporation sensor alarm

5.5、其他故障分析与处理 Other fault analysis and processing

故障状态 Fault state	原因分析 Analysis of the reasons	故障排除方法 Solutions
<p>电源接通后，柜内温度过高，但空调不运转。</p> <p>Power on the switch, the cabinet temperature is too high but the air conditioner is not working.</p>	<p>1、停电或无电源。 Power failure or no power.</p> <p>2、设定温度高于柜内温度。 The cooling set temperature is higher than the cabinet temperature.</p> <p>3、系统故障。 System fault.</p>	<p>1、检查电源、电路。 Check the power supply and the electric circuit.</p> <p>2、根据需要设定压缩机启动温度。 Setting cooling temperature according to the needs.</p> <p>3、请与专业维修人员联系。 Please contact professional maintenance.</p>

<p>设备正常运转，但制冷效果不理想</p> <p>The air conditioner is running but the cooling effect is not good.</p>	<p>1、该机型制冷能力与负荷不匹配。</p> <p>The cooling capacity of the air conditioner is not match with the load.</p> <p>2、环境温度过高。</p> <p>The ambience temperature is too high</p> <p>3、其他系统故障。</p> <p>Other system fault</p>	<p>1、 根据负荷大小重新选配或增配制冷设备。</p> <p>To add or choose another air conditioner according to the load.</p> <p>2、 请确保机器工作环境温度在正常使用范围内。</p> <p>Ensure the machine is used in the correct range.</p> <p>3、 请与专业维修人员联系。</p> <p>Please contact professional maintenance.</p>
<p>正常运转中。突然停止制冷，且电器系统无故障。</p> <p>The machine is stopping suddenly, and the electric system is normal.</p>	<p>1、 柜内温度已达到设定温度。</p> <p>The cabinet temperature greater than or equal to the cooling set temperature.</p> <p>2、 其他系统故障。</p> <p>Other system fault.</p>	<p>1、 根据需要设定压缩机启动温度。</p> <p>Setting cooling temperature according to the needs.</p> <p>2、 请与专业维修人员联系。</p> <p>Please contact professional maintenance.</p>

6. 产品维护 Maintenance

➤ 准备工具 Prepare tools

表 6-1 维护工具 (Table 6 -1 Malignance Tools)

序号//No.	工具 Tools
1	万用表//Multimeter
2	十字螺丝刀//Phillips screwdriver
3	一字螺丝刀//Slotted screwdriver

➤ 日常维护 Routine maintenance

为确保制冷系统良好运行、排水顺畅及电气系统安全稳定，维持设备正常运行与良好性能，避免因维护不当导致设备寿命缩短、运行品质下降，请严格按照以下事项进行

Purpose: To ensure the proper operation of the refrigeration system, smooth drainage, and the safety and stability of the electrical system, maintain the normal operation and good performance of the equipment, and avoid shortened equipment service life and reduced operational quality due to improper maintenance, please strictly follow the following items as specified

6.1 冷凝器清洗/Condenser clearance

为了确保制冷系统良好的运行，请每年清洗一次冷凝器（如果环境比较脏建议增加清洗次数），本产品内外循环间防护等级高达 IP55，可直接用水或压缩空气对冷凝器进行清洗。

To assure the cooling system running perfectly, the condenser should be cleared once annually（if it is too dirty, the times can be increased），this unit IP grade is IP55, so can clear the condenser with water directly.

6.2 排水检查并疏通/Drainage inspection and dredging

为排水顺畅，需不定期检查排水孔是否堵塞并疏通。

To ensure smooth drainage, it is necessary to check the drainage holes regularly for blockages and dredge them.

6.3 电气系统检查/Electrical system check

检查供电系统电压、电缆线及通讯线是否良好。

检查产品本身运行是否正常。

检查产品制冷效果是否良好。

至少每年检查 2 次。

Check the power supply and communication cable.

Check the unit running perfectly or not.

Check the cooling performance good or not.

Check the air conditioner at least 2 times every year.

6.4 注意/Maintenance attention

不要用有机溶剂清洗本产品。

检修时请注意关闭电源。

若外风机风叶上积满了灰尘，可用毛刷清除。

长时间不使用本产品时，请关闭电源。

安装螺丝牢固。用螺丝刀拧动空调的安装螺丝，观察是否有松动现象，若有松动现象，则拧紧螺丝。

Don't clear air conditioner with organic solvent.

PLS power off it before carry out maintains.

The external side fan can be cleaned with a brush if dust accumulated on fan blades.

Please power off the unit before long time stop running.

Screw firmly. Use screwdriver to screw the screws and watch whether the screw is loosening. If the screw is loosening, please tighten it. Establish a systematic maintenance ledger to achieve preventive maintenance.

6.5 维护记录与数据分析/Data Record

建立系统化维护台账，实现预防性维护。

Establish a systematic maintenance ledger to achieve preventive maintenance.

7. 产品质保 Warranty

➤ 保修期 Warranty period

产品质保 12 个月（从产品开始运行时起），或最大 18 个月（从产品发货日时起），与公司另有协议的以协议为准。

The product guarantee period is 12 months from product up-running time or Max. 18 month from product delivery date, or depends on agreement with the company.

➤ 质保范围 Warranty coverage

本产品在本保修期内，凡属于产品本身质量问题而导致故障的，本公司将为您免费维修，客户报修时需提供产品标号。但是由以下任何原因造成的故障不属于我司的保修范围。

1) 已超过保修期的；

- 2) 不能提供产品出厂编号的（见机身贴示的铭牌）；
- 3) 由于在异常条件或环境中运行，或者用非本使用说明书中指定的不恰当安装方式安装、维护或操作导致的故障；
- 4) 非本设备造成的故障，比如由用户的设备、用户的软件等造成的故障；
- 5) 用户自行更换或拆装产品零部件造成损坏的，或由非授权维修服务者拆修而造成损坏的；
- 6) 诸如火灾、地震、洪水等不可抗拒力而造成损坏的故障。

During the warranty period, all belong to the product itself quality problems caused by fault, the company will be free for you to repair; Household repair is required to provide the product label. But by any of the following causes the failure does not belong to our warranty.

- 1) Out of the Warranty period
- 2) Cannot provide the product label(the product label is on the nameplate);
- 3) Because of the abnormal condition or environment ,or the instructions specified in the inappropriate installation, maintenance or operation causes the fault;
- 4) Not caused by equipment failure, caused by user's other equipment or software.
- 5) User changed or disassembles by their-selves, or maintained by the person without authorization.
- 6) Caused by force majored such as fires, earthquakes, floods and other damage to the fault.

➤ 免责声明 Disclaimer

我司的保修仅限于已发送的产品。我司对可能由设备故障衍生的任何损失不负责任。

The warranty is limited to the delivered products. Division I am irresponsible for any loss that may be derived by equipment failure

8. 回收处理 Reclaim



到本产品使用期限或不再使用该产品时，请勿将本产品直接作为垃圾处理，请交给当地政府认可的废物收集中心进行处理。

At the end of the unit working life, the produce must not be disposed of as urban waste; it must be taken to a special local authority differentiated waste collection centre or to a dealer providing this service.