

用户手册
User Manual

工业空调系列
Industrial Air Conditioner Series

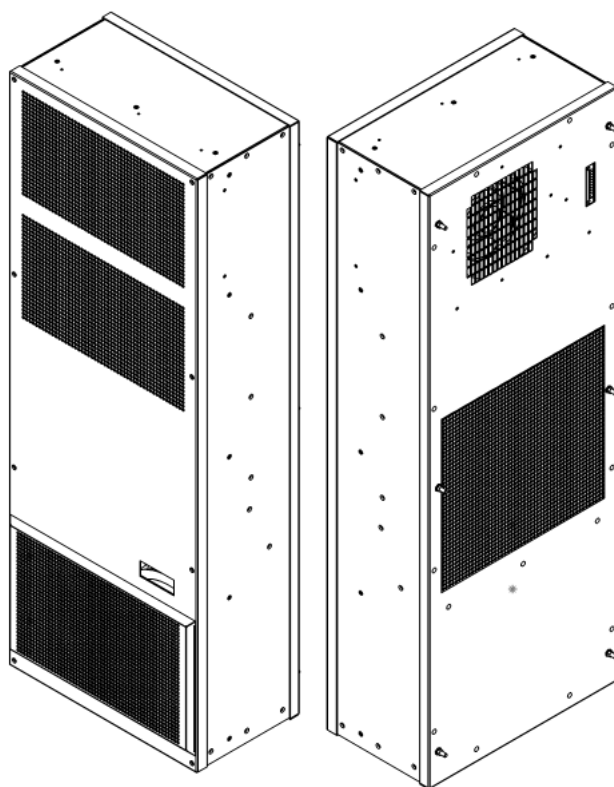

在产品安装使用前请仔细阅读本手册！
Reading this manual carefully before installation and using!

前言 Foreword

本手册介绍了工业空调系列的使用须知、产品接线、操作指导、日常维护等信息。

本手册主要用来指导用户进行安装，维护本系列空调产品。

针对本系列产品的任何操作必须由专业的技术人员根据本手册的要求进行。

The manual describes industrial air conditioner series, wiring, operating instructions.

The manual is mainly used to guide users to install and maintain the series of air conditioners.

For the series of products of any operation must be made by the professional technicians according to the requirements of the manual.

变更记录 **Change History**

版本//Version	文件历史 // Change History	日期 // Date
A	创建 // Created	2006-08-06
B	更新维保内容// Update maintenance content	2026-03-24

目录 contents

前言 Foreword	2
变更记录 Change History	3
声明 Declaration	5
1. 简介 Brief Introduction	6
1.1 产品描述 Product description	6
1.2 型号描述 Model description	7
1.3 符合标准 Conform to the standard	7
2. 包装与运输 Packing and Shipping	8
3. 安装 Installation	9
3.1 安装前准备 Before Installation	9
3.2 空调器安装 Air Conditioner Installation	9
3.3 电气布线 Electrical Wiring	12
3.4 冷凝水汽化装置 Condensed water vaporizing device	12
4. 运行逻辑（选配） Operation Logic	13
4.1 开机运行 Running	13
4.2 控制逻辑 Control Logic	14
4.3 手操器使用说明（选配） Instructions of Display Panel	错误!未定义书签。
4.4 告警与故障（选配） Alarm and Fault	错误!未定义书签。
4.5 其他故障分析与处理 Other fault analysis and processing	14
5. 产品维护 Maintenance	15
6. 产品质保 Warranty	16
7. 回收处理 Reclaim	18

声明 **Declaration**

RoHS Compliance Declaration of Cabinet AC air conditioner

European Guidelines 2011/65/EU (RoHS)

Legal regulation for Substances

Dear Sir/Madam,

Referring to the European guideline of 2011/65/EU, we confirmed that according to the current status of our knowledge and in accordance with the regulations, we could produce products complying with above mentioned guidelines especially for below type:

Yours sincerely

1. 简介 Brief Introduction

1.1 产品描述 Product description

本产品广泛应用于户内机床、电池柜、电气柜、工业控制柜等需要散热的场合。

电网适用范围：交流 230VAC \pm 15% 50Hz/60Hz

其他电源制式请参考铭牌。

注意：在运输、储存以及使用过程中，必须严格按照包装上的指示保持空调竖直向上放置。

This product is widely used in the indoor machine, battery cabinet, industrial control cabinet need to be cooling occasions

Grid application scope: AC 230VAC \pm 15% 50Hz/60Hz

Other power supply system, please refer to the nameplate.

Warning: In the process of transportation, storage and use must be in strict accordance with the instructions on the package to keep air conditioning placed vertically upward.

1.2 型号描述 Model description

举例// For example:

.....

1.3 符合标准 Conform to the standard

Standard	Description
GB/T 17626	Electromagnetic compatibility(EMC)
GB4706.1	Safety household and similar electrical appliance
GB4798.1	Environmental conditions existing in the application of electric and electronic products - storage
GB4798.2	Environmental conditions existing in the application of electric and electronic products - transport
GB4798.3	Environmental conditions existing in the application of electric and electronic products - use
CE	The third party certification

2. 包装与运输 Packing and Shipping

- 空调采用纸箱包装，附件等资料也放置于包装箱内。

Air conditioner packed in paper cases, the package includes Annex.

- 空调在运输时请注意以下事项：

The air conditioner during the transportation, please pay attention to the following matters:

Warning

图 2-1 包装箱标识

Figure2-1 Packing mark

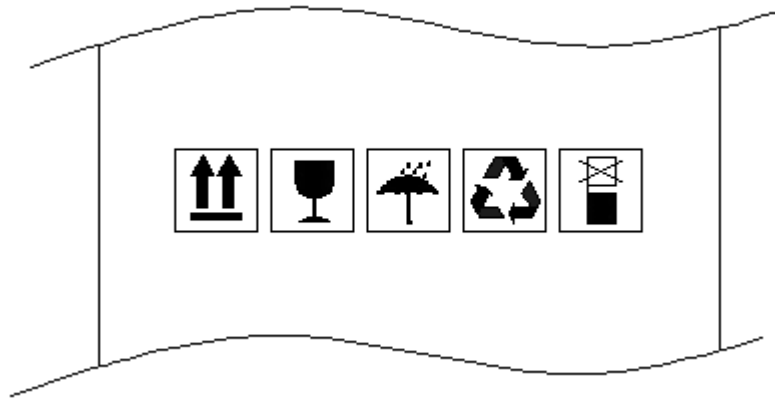

- 搬运或者运输过程中空调必须按朝上放置。严禁倒置、平放、过度倾斜及碰撞。
During Handling or transport, Air conditioner must be upward placed as  No inverted, flat, excessive tilt and collision.
- 空调为精密仪器，在搬运或者运输过程中，应小心轻放，包装箱上禁止踩踏，禁止站立或放置其他重物。
Air conditioner is precision instrument, in handling or transport process, should be handled with care, package boxes do not step, prohibit standing or placing other heavy objects.
- 搬运或运输过程中，注意防潮、防水、防雨。
During Handling or transporting, pay attention to moisture, water, rain.

3. 安装 Installation

3.1 安装前准备 Before Installation

安装前至少需准备以下工具：十字螺丝刀、一字螺丝刀、密封条、老虎钳。

You have to prepare the following tools before installation: cross screwdriver, slot type screwdriver, sealing strip, vice.

3.2 空调器安装 Air Conditioner Installation

➤ 安装步骤：

1. 在安装面上画出柜门开孔示意图，将阴影部分切割掉。不同型号空调的柜门开孔示意图请参考相应规格书；
2. 根据下图示意，将空调器安装在机柜上；（此安装方式为螺柱安装，需选配双头螺柱）

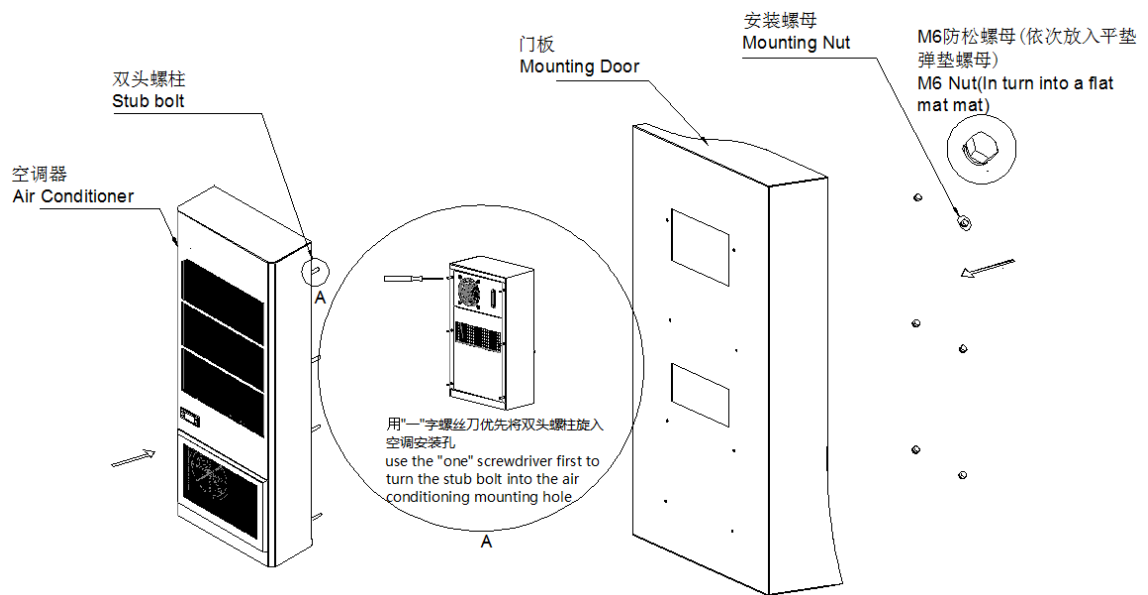

3. 下图为机器安装后效果图及机柜内部安装后双头螺柱伸出的长度，请作参考；

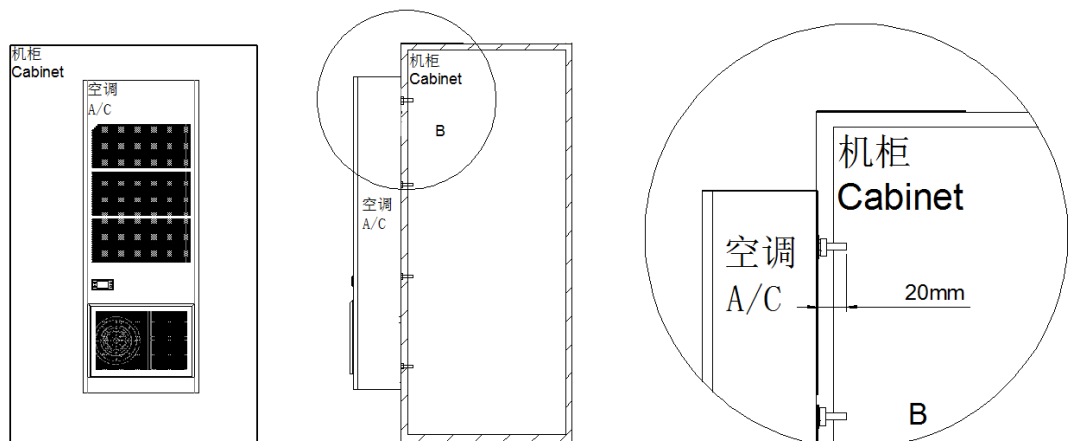

- Installation steps:
 1. Draw on the cabinet mounting cut-out map according to Figure, cut off the shadow part. Different models of air conditioner cabinet mounting cut-out maps refer to its specification.
 2. According to the direction of the schematic of installation, installed the air conditioner on the cabinet. (This installation is installed in the stud mounting. It needs stub bolt)
 3. The following picture shows the length of the post after the installation of the machine and after the installation of the cabinet. Please refer to it.

- 安装完成后的确认检验项：
 1. 请勿在高油污、易燃气体、高腐蚀性及环境温度超过 55℃、湿度超过 95%的环境下使用该产
品；
 2. 确保产品安装后倾斜度不大于 3°；
 3. 确保控制柜密封良好以免漏入空气产生不必要的冷量损失和产生过多的冷凝水；
 4. 产品安装结束后，确保产品直立 30 分钟后再加电运行。

- Double check lists after Installation:
 1. Don't apply this unit in high oil, burning gas, explosive gas, strong corrosively condition, the ambient air must be under 55℃, and the humidity not higher than 95%;
 2. Make sure that the lean of the product no more than 3°;
 3. Make sure that the cabinet should be sealed well to avoid the cooling losing and avoid ambient moisture penetrate into cabinet, this will avoid produce more condensate water;
 4. Ensure that the product is up and running in upright 30 minutes.

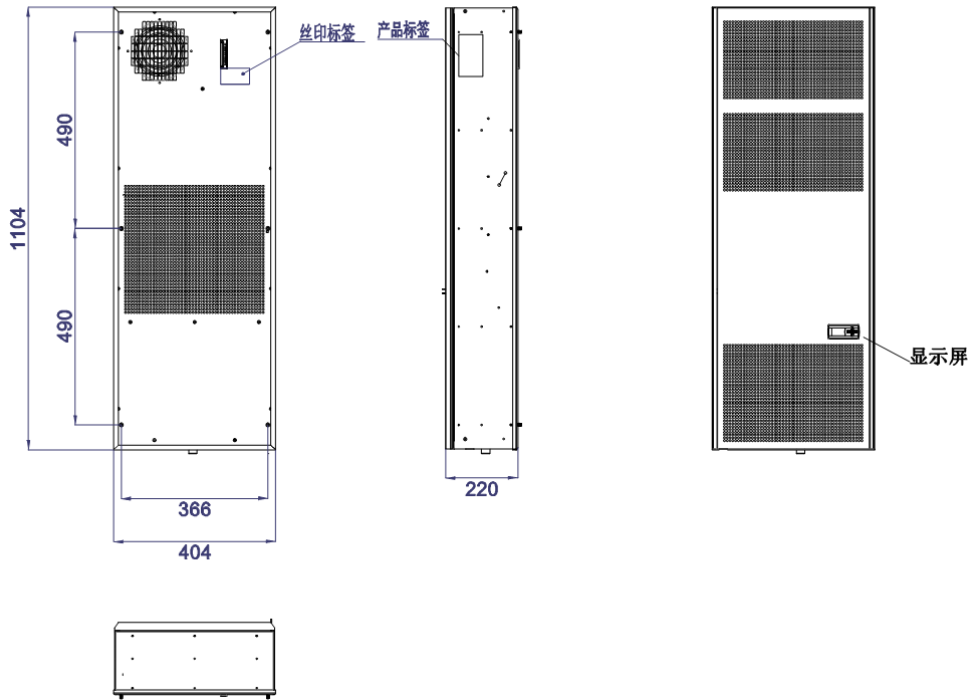

CGG200-A2H11 安装开孔图

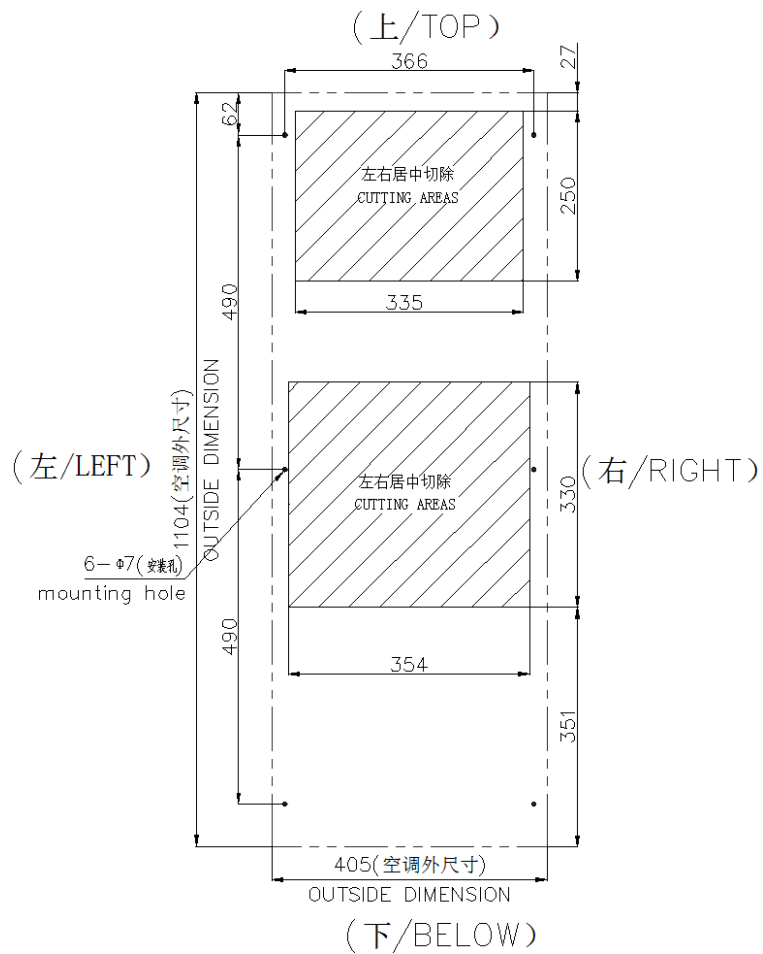

3.3 电气布线 Electrical Wiring

空调器在使用前需根据本手册的说明进行电气连接，建议客户优先使用附件中的线缆。客户可以自备线缆，如果客户不能确定所选电缆规格是否合适，可联系售后服务部门。

Does Electrical Wiring according to the manual before use the air conditioner; we suggested preferring to use cables in the attachments. You should call the After-sale Service Department, if you cannot sure the cable specification be made by your-self.

图 3-1 电源端子示意图

Figure 3-1 Schematic of power terminal



表 3-1 接线端子说明 Table 3-1 Terminal instructions

序号//No.	符号//Symble	定义//Definition
1:	L	交流电源火线 Live line of AC power
2:	N	交流电源零线 Neutral line of AC power
3:	PE	交流电源地线 Ground wire of AC power
4:	T/R+	RS485通讯正极 Positive pole of 485 communication
5:	T/R-	RS485通讯负极 Negative pole of 485 communication
6:	NO	告警输出常开端 Normal open port of dry contract alarm output
7:	COM	告警输出公共端 Common port of dry contract alarm output
8:	NC	告警输出常闭端 Normal closed port of dry contract alarm output
9、10:	I/O	外部控制输入/排氢 (选配) Hydrogen discharging port or external signal input port

4. 运行逻辑 Operation Logic

4.1 开机运行 Running

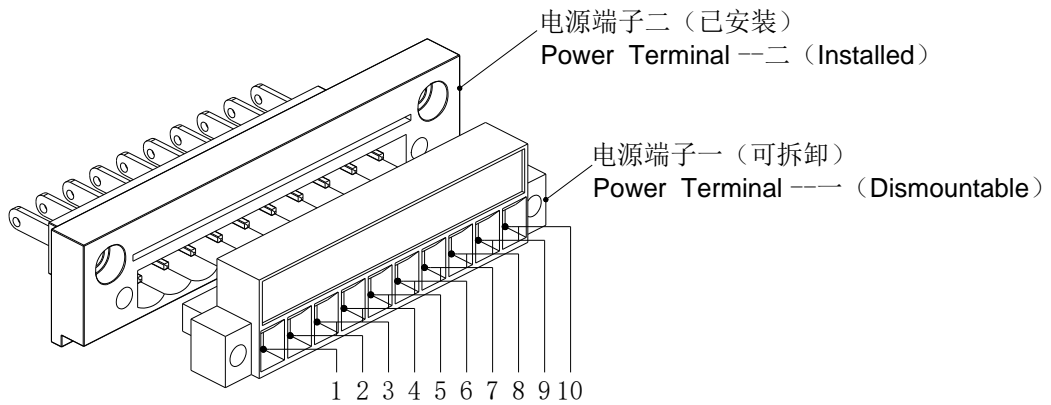
接线完成并确认接线正确后，此时可接通交流电源使空调首次上电运行。

空调上电后，首先执行自检程序，依次对内风机、温度传感器、外风机、压缩机进行检验。

自检过程中若发现故障则显示相应故障告警并进入告警状态。

Completed and confirmed the wiring correct, then you can connect to the AC power to air conditioner for the first time to run on electricity.

After power on air conditioner, first of all it will be self-checking: internal fan, temperature sensor, heater, external fan, and compressor.

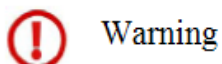

Warning

空调上电运行过程中，若发生异常噪音、震动，请立即切断电源，并通知专业人士进行检查。

When the air conditioner is running, if there is abnormal noise, vibration, please cut off power immediately and notify the professionals to inspect.

4.2 控制逻辑 Control Logic

运行模式：待机模式、制冷模式、告警模式。

Operational mode: standby, cooling, and alarming.

➤ 待机模式

若回风温度 < 压缩机启动设置温度（默认 35℃），则空调处于待机模式，此时只运行内风机，显示器显示当前回风温度。

➤ Standby mode

If the return air temperature is lower than the default set point of Compressor start temperature (35℃), the air conditioner is in a standby mode. At this time, the internal fan is running only, the monitor displays the current return air temperature.

5. 产品维护 Maintenance

➤ 准备工具 Prepare tools

表 5-1 维护工具 (Table 5 -1 Malignance Tools)

序号//No.	工具 Tools
1	万用表//Multimeter
2	十字螺丝刀//Phillips screwdriver
3	一字螺丝刀//Slotted screwdriver

➤ 日常维护 Routine maintenance

为确保制冷系统良好运行、排水顺畅及电气系统安全稳定，维持设备正常运行与良好性能，避免因维护不当导致设备寿命缩短、运行品质下降，请严格按照以下事项进行

Purpose: To ensure the proper operation of the refrigeration system, smooth drainage, and the safety and stability of the electrical system, maintain the normal operation and good performance of the equipment, and avoid shortened equipment service life and reduced operational quality due to improper maintenance, please strictly follow the following items as specified

5.1 冷凝器清洗/Condenser clearance

为了确保制冷系统良好的运行，请每年清洗一次冷凝器（如果环境比较脏建议增加清洗次数），本产品内外循环间防护等级高达 IP55，可直接用水或压缩空气对冷凝器进行清洗。

To assure the cooling system running perfectly, the condenser should be cleared once annually (if it is too dirty, the times can be increased), this unit IP grade is IP55, so can clear the condenser with water directly.

5.2 排水检查并疏通/Drainage inspection and dredging

为排水顺畅，需不定期检查排水孔是否堵塞并疏通。

To ensure smooth drainage, it is necessary to check the drainage holes regularly for blockages and dredge them.

5.3 电气系统检查/Electrical system check

检查供电系统电压、电缆线及通讯线是否良好。

检查产品本身运行是否正常。

检查产品制冷效果是否良好。

至少每年检查 2 次。

Check the power supply and communication cable.

Check the unit running perfectly or not.

Check the cooling performance good or not.

Check the air conditioner at least 2 times every year.

5.4 注意/Maintenance attention

不要用有机溶剂清洗本产品。

检修时请注意关闭电源。

若外风机风叶上积满了灰尘，可用毛刷清除。

长时间不使用本产品时，请关闭电源。

安装螺丝牢固。用螺丝刀拧动空调的安装螺丝，观察是否有松动现象，若有松动现象，则拧紧螺丝。

Don't clear air conditioner with organic solvent.

PLS power off it before carry out maintains.

The external side fan can be cleaned with a brush if dust accumulated on fan blades.

Please power off the unit before long time stop running.

Screw firmly. Use screwdriver to screw the screws and watch whether the screw is loosening. If the screw is loosening, please tighten it. Establish a systematic maintenance ledger to achieve preventive maintenance.

5.5 维护记录与数据分析/Data Record

建立系统化维护台账，实现预防性维护。

Establish a systematic maintenance ledger to achieve preventive maintenance.

6. 产品质保 Warranty

➤ **保修期 Warranty Period**

产品质保 12 个月（从产品开始运行时起），或最大 18 个月（从产品发货日时起），与公司另有协议的以协议为准。

The product guarantee period is **12 months** from product up-running time or Max. **18 month** from product delivery date, or depends on agreement with the company.

➤ **质保范围 Warranty Coverage**

本产品 在保修期内，凡属于产品本身质量问题而导致故障的，本公司将为您免费维修，客户报修时需提供产品标号。但是由以下任何原因造成的故障不属于我司的保修范围。

- 1) 已超过保修期的；
- 2) 不能提供产品出厂编号的（见机身贴示的铭牌）；
- 3) 由于在异常条件或环境中运行，或者用非本使用说明书中指定的不恰当安装方式安装、维护或操作导致的故障；
- 4) 非本设备造成的故障，比如由用户的设备、用户的软件等造成的故障；
- 5) 用户自行更换或拆装产品零部件造成损坏的，或由非授权维修服务者拆修而造成损坏的；
- 6) 诸如火灾、地震、洪水等不可抗力而造成损坏的故障。

During the warranty period, all belong to the product itself quality problems caused by fault, the company will be free for you to repair; Household repair is required to provide the product label. But by any of the following causes the failure does not belong to our warranty.

- 1) Out of the Warranty period
- 2) Cannot provide the product label(the product label is on the nameplate);
- 3) Because of the abnormal condition or environment ,or the instructions specified in the inappropriate installation, maintenance or operation causes the fault;
- 4) Not caused by equipment failure, caused by user's other equipment or software.
- 5) User changed or disassembles by their-selves, or maintained by the person without authorization.
- 6) Caused by force majored such as fires, earthquakes, floods and other damage to the fault.

➤ **免责声明 Disclaim**

我司的保修仅限于已发送的产品。我司对可能由设备故障衍生的任何损失不负责任。

The warranty is for the delivered products.
Irresponsible is for any loss that may be caused by equipment failure.

7. 回收处理 Reclaim



到本产品使用期限或不再使用该产品时，请勿将本产品直接作为垃圾处理，请交给当地政府认可的废物收集中心进行处理。

At the end of the unit working life, the produce must not be disposed of as urban waste; it must be taken to a special local authority differentiated waste collection centre or to a dealer providing this service.