

机柜热交换器

Cabinet Heat Exchanger

使用说明书

User Manual

在产品安装使用前请仔细阅读本手册！
Read this manual carefully before installation and using!

前言 Foreword

概述 Summary

该手册介绍 T E ***/**/D 系列机柜热交换的使用须知、声明、产品概述、安装指导以及产品维护和质保。

The manual describes the series of T E ***/**/D cabinet heat exchanger instructions, declaration, product overview, installation guide, maintenance and warranty.

变更记录 Change History

Version 版本	Change History 文件历史	Draft by 起草	Approved by 批准	Date 日期
A	Created	Liyifeng		2019.3.22

目 录 Catalog

前 言 Foreword	ii
变更记录 Change History	iii
1 使用须知 Instructions	5
2 声明 Declaration	6
3 产品概述 Product Overview	8
3.1 应用 Application	9
3.2 产品特点 Product features	10
3.3 工作原理 Working Principle	11
3.4 风道设计 Air flow design	12
3.5 运行逻辑 Operation logic	12
3.6 显示屏操作指导 Monitor operation guide	14
3.7 告警与故障管理 Alarm and fault management	16
3.8 监控 Monitoring	17
4 安装指导 Installation guide	17
4.1 设备安装 Machine installation	17
4.2 电气安装 Electrical installation	20
5 产品维护和质保 Maintenance and Warranty	23
5.1 产品维护 Product maintenance	23
5.1.1 准备工具: Prepare tools	23
5.1.2 日常维护 Routine maintenance	23
5.1.3 告警代码及处理方法 Alarm code and handling method	25
5.1.4 其他故障分析与处理 Other fault analysis and treatment	26
5.2 售后服务和维修 Service and repair	26
5.3 回收处理 Reclaim	27

1 使用须知 Instructions

- 本手册适用于：T E ***/**/D 系列机柜热交换器

This manual is for: the series of T E ***/**/D cabinet heat exchanger

- 使用本机前请务必阅读本使用说明书。

Be sure to read this manual before using the unit.

- 用户必须按照本手册规定的内容执行才可享受到产品正常质保服务。

Only when the user operate the unit in accordance with the user manual in warranty period

Qucik can offer maintenance with free of charge.

2 声明 Declaration

RoHS Compliance Declaration of Cabinet heat exchanger

European Guidelines 2011/65/EU (RoHS)

Legal regulation for Substances

Dear Sir/Madam,

Referring to the European guideline of 2011/65/EU, we confirmed that according to the current status of our knowledge and in accordance with the regulations, we could produce products complying with above mentioned guidelines especially for below type:

Yours sincerely,

Engineering Department



Declaration of Conformity

Suzhou Quick Thermal Control Co. Ltd

We herewith declare the following products:

Product Name: T E ***/**/D series products

series products is in conformity with the following directives:

2006/ 42 / EC	Machine Directive	EN ISO 12100 Machine Safety
2006 / 95 / EC	Low Voltage Directive	EN 60 335-1:2012
2004 / 108 / EC	EMC-Directive	EN 60 335-2-40:2012
2009/ 105 / EC	Simple Pressure Vessels	EN 61000-6-1:2007 Immunity
97/23/EEC	The Pressure Equipment Directive, article3 paragraph 3.	EN 61000-6-4, Emission
	The Pressure Equipment Directive,category1	
	The Pressure Equipment Directive,category2	

and was manufactured in conformity with the following harmonised standard:

furthermore manufactured in conformity with the following disharmonised standard:

2011/65/EU	RoHS Directive
2002/96/EC	Waste of Electrical and Electronic Equipment (WEEE)

and furthermore declares that it is not allowed to put the machinery into service until the machinery into which it is to be incorporated or of which it is to be a component has been found and declared to be in conformity with the provisions of above-mentioned Directives and with national implementing legislation i.e. as a whole, including the machinery referred to this declaration.

3 产品概述 Product Overview

关于本章 About this chapter

本章介绍了 **TE ***/*/*/D** 机柜热交换的应用、产品特点、工作原理、风道设计、运行逻辑、显示屏操作指导以及告警及故障处理信息。请严格按照本手册的相关规定执行！

This chapter describes the **TE ***/*/*/D** cabinet heat exchanger application, product features, the working principle, duct design, operation logic, monitor operation guide and alarm and fault processing of information. It is required to strictly operate the unit according to this user manual.

3.1 应用 Application



Important

- 该产品是专为通讯或相关工业设备应用场合而设计的高性能机柜热交换器，使用交流电源和直流电源供电（请参考产品铭牌）。其安装的意义在于对控制柜（正常工作时为密闭状态）内部实行温度控制，以保证柜内的所有热敏元件可以正常工作，发挥其最佳工作性能。

The product is designed for communication or related industrial equipment applications and design of high performance cabinet heat exchanger , Please use the AC and DC power (Please refer to the nameplate) , The installation is the significance of the control cabinet (normal work to a closed state) of internal temperature control, To ensure that the cabinet all thermal element can work normally, Play the best performance.

- 除以上说明的应用场合以外的其他任何场合使用所造成的任何损害，我方不承担责任。
Any damage caused by any other applications outside of the application object described above, Responsibility is not assumed.



Warning

- 运输：搬运或运输该产品过程中，请注意保护产品，请勿过度撞击。

Transport: In the process of handling or transport of the product, do protect the product and do not over impact.

- 存放：不要露天存放，或者长时间存放在高温、高湿的环境下(70°C,95%)。

Store: Don't open storage, or stored for a long time at high temperature, high humidity environment (70°C,95%).

- 关机：若长时间不使用该产品，请关掉主电源。

Shutdown: If not using this product for a long time, please turn off the main power



Warning

- 严禁未成年人、身体或心理存在严重缺陷及不具有相关该产品知识的人员操作该产品。

This appliance is not intended for use by persons (including children) with reduced physical, sensory or mental capabilities, or lack of experience and knowledge, unless they have been given supervision or instruction concerning use of the appliance by a person responsible for their safety.

- 为了避免风险，电源线请务必使用同一公司或使用同规格的有安规认证的产品

If the power supply cord is damaged, it must be replaced by the manufacturer, or service agency or Safety certification in order to avoid a hazard.

-
- 为了更好的使用本产品，请勿在高油污、高腐蚀性环境、含爆炸易燃气体环境使用，否则，将会造成对该产品严重的损害，我们将不会提供正常的售后服务。

Don't use the product under the condition of high oil, burning gas, explosive gas, strong corrosively condition area. Otherwise the product warrantee service is not been offered by manufacture.

3.2 产品特点 Product features

- 适合高温工况
Suitable for high temperature
- 开机自检
Self testing function
- 报警输出功能
Alarming output to monitoring system
- 维护方便
Easy maintenance
- 实现遥测、遥信、遥调，可实现多重自动保护和全面的故障自诊断功能；
Remote measuring, remote communication, remote control, which can realize can realize multiple automatic protection and comprehensive self-testing function;
- 多重保护功能、可视化人机界面、RS485 接口 (MODBUS-RTU 协议) ;
Multiple self-protection design & visible monitoring interface, RS485 communication port (MODBUS-RTU protocol);

3.3 工作原理 Working Principle

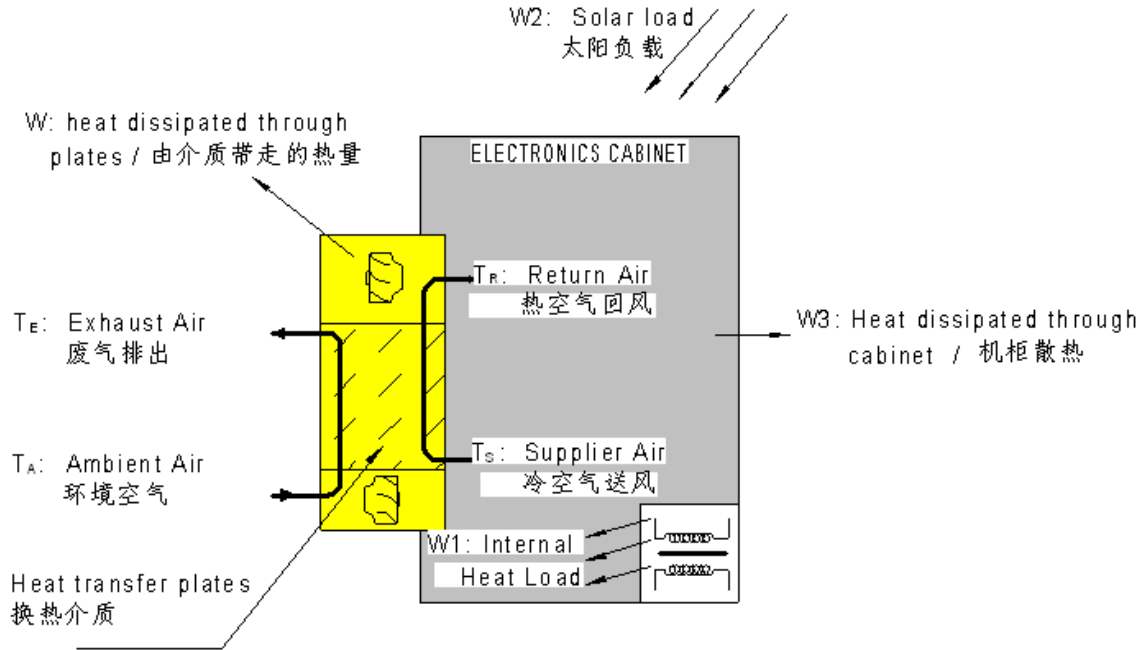

热交换器通常用在对密封区域的降温，TE ***/*/*D 系列的热交换器是专为机柜而设计的产品。热交换器因需要环境温度进行调节，因此需要有一个通道与外界相通。密闭的内部空气通过环境空气而实现冷却。内、外循环的离心风扇使空气产生对流，通过中间的换热装置实现热量的传递。

Heat exchanger is mostly used for enclosed area cooling, TE ***/*/*D series HEX is designed especially for mounting in a cabinet. The unit uses ambient air for temperature regulation so it must have access to ambient. The internal temperature of the enclosure is cooled via effective utilization of the ambient air. An air/air counter-current plate heat exchanger is used to transfer the heat. Two centrifuge fans, one for the internal circuit and one for the external circuit provide ventilation.

热交换器内的风扇的风速是由温度控制的，是基于一个已调整好的模式而设计的。

The heat exchanger module is designed in such a way that the speed of the external circuit fan is controlled according to temperature, based on the pre-set pattern.

3.4 风道设计 Air flow design

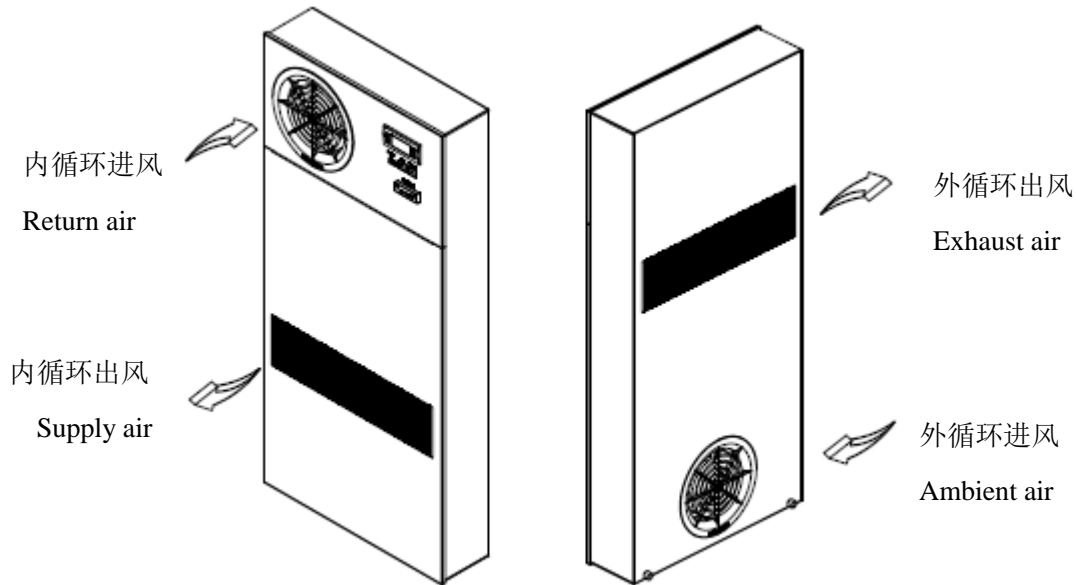

3.5 运行逻辑 Operation logic

热交换器上电，首先进行自检程序，若自检过程中发现故障。则产生告警，显示器显示告警故障代码，进入故障处理模式。若自检过程中无故障，则自检结束后按照正常模式运行。

Power on the switch, the product will perform a self-test running program firstly. If there is any trouble during self-test, the alarm will be generated, the monitor Display alarm fault code, the system according to the alarm fault code to enter fault handling operation. If there is no trouble during the self-test, system will be normal running automatically.

- **自检: Self-test**

自检过程如下: The self-test procedure is as follows:

第一步: 检测回风温度传感器;

First: Detection of return air temperature sensor;

第二步：检测内风机；

Second: Detection of internal fan;

第三步：检测外风机；

The Third: Detection of external fan;

第四步：检测加热器(如果机器带有加热器功能)；

The Fourth: Detection of heater (If the machine with heating function) ;

系统的正常工作状态包括待机、换热和加热三种状态。

The normal work state of the system includes the state of standby, heat transfer and heating.

注：如果因为未接通交流电引起的加热器告警，此告警可以通过再次输入交流电源与直流电源消除。

Note: if the heater alarm is sent for no AC power input, it can recover by re-input AC and DC power.

- 待机运行 Standby mode

若回风温度满足待机运行条件(无需换热或加热时)，则热交换器进入待机运行状态，此时只低速运行内风机。

If the return air temperature meets the condition of the Standby mode (not need heating or heat transfer), the heat exchanger runs into the standby operating state, At this point only the low speed fan inside.

- 换热运行 Heat exchange mode

若回风温度满足换热运行条件（柜内温度高于外风机开启温度），则热交换器进入换热运行状态，此时内外风机会根据柜内温度的不同进行调速运行。

If the return air temperature meets the condition of the heat exchanger (cabinet inner temperature is higher than the outer fan start temperature), the heat exchanger runs into the heat transfer state, At this point the fan will change speed according to the cabinet inner temperature.

- 加热运行（可选） Heating (Option)

若回风温度满足加热运行条件（柜内温度低于加热器运行设置温度点时），则热交换器进入加热运行状态，此时内风机全速运行，外风机关闭。

If the return air temperature meets the heating condition (When cabinet inner temperature is lower than the heater running temperature), the product will run into heating, with internal fan full speed, external fan stopped.

3.6 显示屏操作指导 Monitor operation guide

显示屏界面如下：The interface of the monitor is as follows:



面板上的指示灯从左到右排列的功能含义如下表：

The definitions of the symbols from left to right are as follows:

指示灯 Indicator	指示灯含义 Definition	亮 Light	闪烁 Flicker
	设定温度 Point setting	参数设置状态 Setting mode	自检 Self test
	换热 Heat exchange	正在换热 Heat exchange mode	NA
	制热 Heat	加热器开 Heater start	加热器故障 Heater Alarm
	外风机 External fan	外风机运转 External fan running mode	外风机告警 External fan Alarm
	告警 Alarm		告警 Alarm mode

- **内风机速度查询 Show RPM of internal fan**

在显示回风温度状态（主界面），同时按下“▲”键，将显示内风机转速，再按 M 键将返回到显示回风温度的主界面。

Under the return air temperature interface, press“▲” will show the RPM of internal fan , press “M”,will show return air temperature back to main interface.

- **外机速度查询 Show RPM of external fan**

在显示回风温度状态（主界面），同时按下“▼”键，将显示内风机转速，再按 M 键将返回到显示回风温度的主界面。

Under the return air temperature interface, press“▼” will show the RPM of external fan , press “M”,will show return air temperature back to main interface.

● 加热器的电流查询 Show the current of heater

在显示回风温度状态（主界面），按同时按住“▼”键和“▲”键，将显示当前加热器的运行电流，单位 A。按一次“M”键，返回到显示回风温度的主界面。

Under the return air temperature interface, press“▼” and “▲” will show the current of the heater(A),press “M”,will show return air temperature back to main interface.

● 直流电压查询 Show the DC voltage

在显示回风温度状态（主界面），按“Set”键，将显示直流电压，单位 V。按一次“M”键，返回到显示回风温度的主界面。

Under the return air temperature interface, press “Set” will show the DC voltage with V unit, press “M”,will show return air temperature back to main interface.

● 控制参数设定 Controls parameter settings

在主显示界面，长按“M”键 5 秒，进入参数设置状态，显示参数代码。参数代码分为用“▲▼”键选择参数代码，选择一个代码后按“Set”键则显示该代码对应的参数值；通过“▲▼”键即可对参数值进行设置；设置完成后再按“Set”键，系统保存新设置的参数并显示 End，然后回到显示参数代码状态；在设置参数时，按“M”键表示放弃，退回显示参数代码但不改变参数值。在显示参数代码时长按“M”键 3 秒可退出参数设置状态。常用设置代码如下表：

Long press "M" key for 5 seconds, enter the parameter setting mode, then display the code of parameters, with "▲ ▼" key to select the code of parameters, select a code and press "Set" button will display corresponding parameter values of the code, then re-use "▲ ▼" button can set the parameters, after finished the setting, press "Set "button, back to display states. During the setting mode, Press "M" key to exit the parameter setting mode, in the process of the parameter values setting by pressing "M" button that give up, quit, but does not change the parameter value. Common settings code as described in the following table:

代码	参数名称	备注
F18	外风机停止温度/External fan stop temperature	
F19	外风机开启温度回差/External fan start temperature	
*F23	加热器开启温度/Heater start temperature	带加热功能机型有效/ With heating function selected
*F24	加热器停止温度回差 /Heater stop hysteresis temperature	带加热功能机型有效/ With heating function selected
F28	通信地址/Communication address	
F29	高温告警温度/ High temperature alarm	
F30	低温告警温度/Low temperature alarm	

F38	外部输入使能/External input enable	
F39	外部输入选项/External input options	
F40	高电压告警值/High voltage alarm value	
F44	密码设置/Password	

注：带“*”设置参数修改需要输入密码。

Note: with "*" setting parameters modification need to enter your password.

3.7 告警与故障管理 Alarm and fault management

显示器正常时显示回风温度值，告警时交替显示回风温度和告警代码，告警代码的含义详见下表。

The monitor displays return air temperature at normally, If it is alarm, temperature and alarm codes are displayed alternately, the alarm code defined as table below.

代码/Code	含义/Meaning	说明/Explain
E01	内风机 1 故障/Int.fan1 defected	
E02	****	
E03	外风机 1 故障/Ext.fan1 defected	
E04	****	
E05	回风温度传感器故障/Inner temperature sensor	
E06	****	
E07	加热器告警/Heater defected	
E08	****	
E09	高温告警/High temperature alarm	
E10	低温告警/Low temperature alarm	
E11	高电压告警/High voltage alarm	
E12	低电压告警/Low voltage alarm	
E13	外部输入告警/The external input alarm	

3.8 监控 Monitoring

热交换器可通过软件监控，只需连接 RS485 接口。请联系厂商以获取更多的信息。

The unit can be monitored by software through RS485 port. Please consult to the manufacture for more information.

4 安装指导 Installation guide

4.1 设备安装 Machine installation

请按照下图示意进行安装

Please follow the below diagram of installation

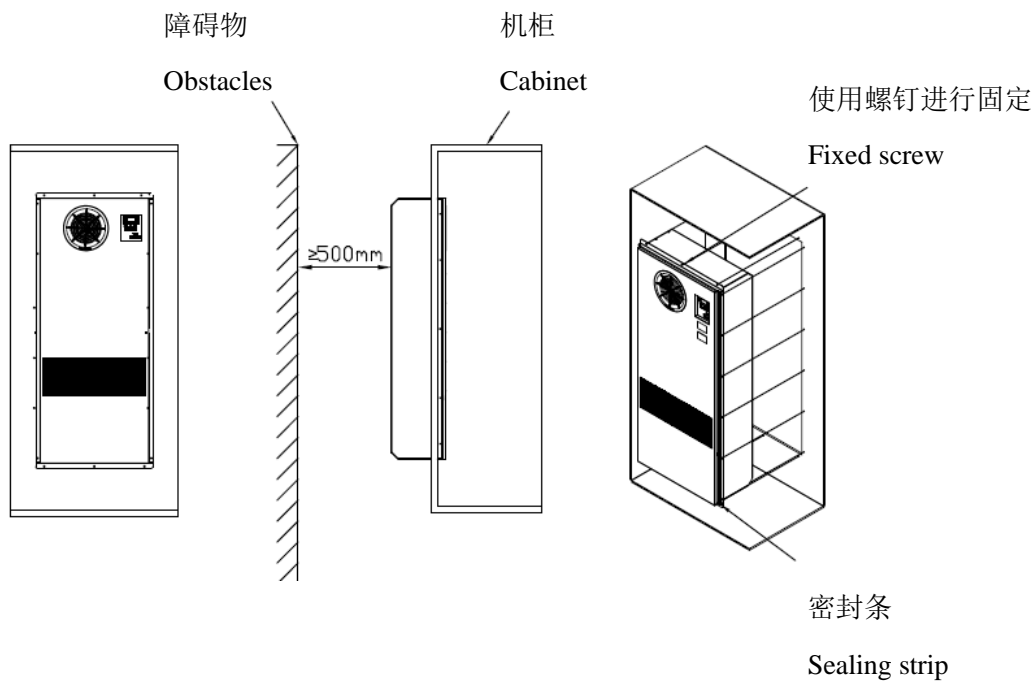

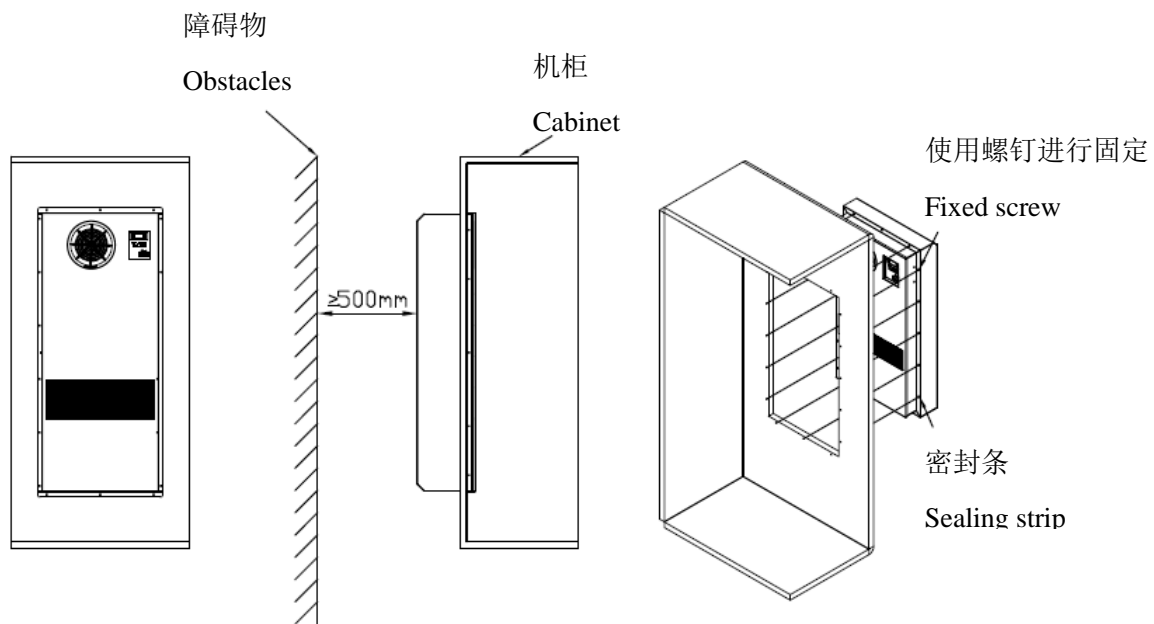

半嵌入安装/Semi-embedded Mounting

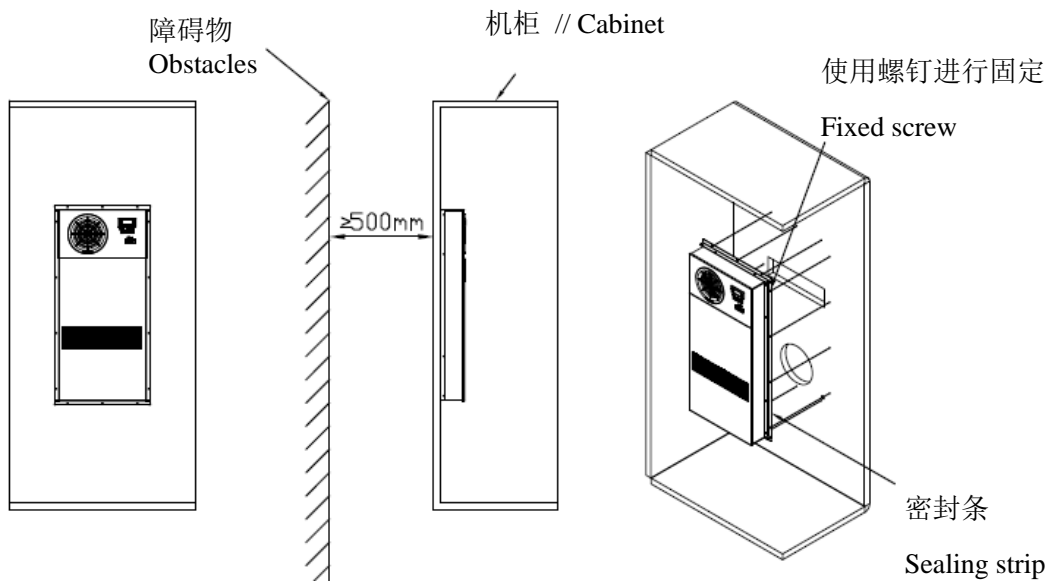

门装/Door mounting

图 4-1 安装示意图 Figure 4-1 Installation diagram

● 安装步骤: Installation steps:

- 1) 拆除热交换器外包装, 核对包装清单, 确认设备是否完好;

Removal of packaging box, check the package list and the machine is well.

- 2) 使用螺栓, 将热交换器按图 4-1 安装在机柜上;

Installed the Heat exchanger on the cabinet use screw, as Figure4-1

- 3) 以上安装步骤完成后, 请再次确认检查。

The mechanical part of installation is finished till now. please double check.



Important

请勿在高油污、易燃气体、高腐蚀性及环境温度超过 65°C、湿度超过 95%的环境下使用该产品。

Don't use this unit in high oil, burning gas, explosive gas, strong corrosively condition, the ambient air must be under 65°C, and the humidity not higher than 95%.



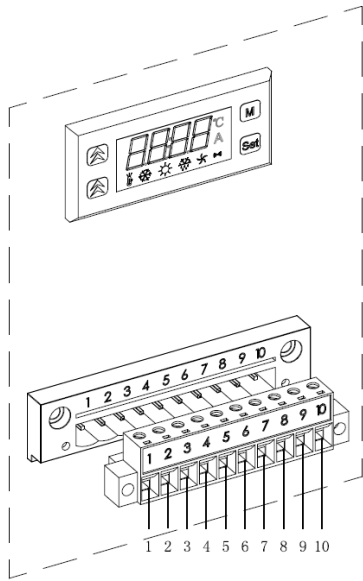

4.2 电气安装 Electrical installation



手操器使用说明：

在正常情况下，手操器显示柜内温度。告警时显示告警代码；





手操器底部为状态栏，不同的指示灯代表不同状态：

- ：常亮表示热交换器处在参数设置状态，闪烁表示自检状态；
- ：常亮表示热交换器正在进行制冷；
- ：常亮表示热交换器正在进行制热；闪烁表示加热器告警；
- ：常亮表示外风机正在运行；闪烁表示外风扇告警；
- ：闪烁表示有告警发生；

Instructions of display panel:

The display panel shows cabinet temperature under normal circumstance. and shows alarm code when is a malfunction.

In the bottom is the status bar, different lamp represents different status.

- ：Lamp on when setting mode; Flashing when self diagnose;
- ：Lamp on when cooling;
- ：Lamp on when heating; Flashing when heater alarm;
- ：Lamp on when external fan is running; Flashing when ext. fan alarm;
- ：Flashing when alarm.

序号/No.	符号/Symbol	定义/Definition	描述/Description
1	0V	直流电源正极/Positive electrode of DC power	/
2	-48V	直流电源负极/Negative electrode of DC power	/
3	PE	电源地线/Ground wire power	/
4	N	交流电源零线/Neutral line of AC power	带加热器时使用 Use with heater
5	L	交流电源火线/Live line of AC power	
6	NO	干接点告警输出-常开端/ Dry contact alarm output-NO	/
7	COM	干接点告警输出-公共端/ Dry contact alarm output-COM	/

8	NC	干接点告警输出-常闭端/ Dry contact alarm output-NC	/
9	RS485 +	通讯接口/Communication interface	/
10	RS485 -	通讯接口/Communication interface	/

4.2.1 用户自配电源、电源线缆及断路器应该满足以下表格要求：

The power, the power cable and the breaker should meet the following form, when they are supplied by customer

项目 // Item	要求 // Request
电源 // Power	直流电源// DC Power:- 48 VDC
	交流电源 // AC Power :220 VAC
电压范围 // Voltage range	DC:48V \pm 20%
	AC: 220V \pm 20%
断路器 // Circuit breaker	建议交流电源断路器不小于 10A The recommended AC power circuit breaker is not less than 10 A
	建议直流电源断路器不小于 10A The recommended DC power circuit breaker is not less than 10 A
电缆规格//Cable specification	建议使用不小于 16AWG 或者 1.0mm ² more than 16AWG or 1.0mm ²

注：建议选用的漏电保护器（RCD）动作电流不要超过 30mA。

Note: The installation of a residual current device (RCD) having a rated residual operating current not exceeding 30mA is advisable.

4.2.2 上电前检查 Pre-operational checks

热交换器的安装和电气连接完成后，请核对下列检查表：

After heat exchanger installation and the electrical connection are completed, please check the following checklist:

序号 Serial number	检查项目 Check items
1	装配螺钉已经紧固。 Ensure the screw is fastening
2	内外循环的进出风口附近无明显的阻挡物。 Ensure that there is enough space near the internal and external of the air condition
3	电源线极性连接正确，告警信号线缆连接正确。 Power line to connect the right polarity Alarm signal cables are connected correctly
4	用万用表检查供电电压，供电电压正常，符合铭牌上的要求。 Using a multimeter to check the supply voltage, power supply voltage is normal, consistent with the requirements on the nameplate.

注：本设备正确的电源型式请参见机身铭牌。如未正确输入电源，将会有告警

Note: the correct power type of the machine sees the nameplate on the machine surface. If the power is not input correctly, the unit will be alarm

Warning

热交换器上电运行过程中，若发生异常噪音、震动，请立即切断电源，并通知专业人士进行检查。

When the heat exchanger is running, if there is abnormal noise, vibration, please cut off power immediately and notify the professionals to inspect.

5 产品维护和质保 Maintenance and Warranty

5.1 产品维护 Product maintenance

5.1.1 准备工具: Prepare tools

表 5-1 维护工具 Table7-1 Maintenance Tools

序号 Number	工具 Tools
1	万用表 Multimeter
2	十字螺丝刀 Phillips screwdriver
3	一字螺丝刀 Slotted screwdriver

5.1.2 日常维护 Routine maintenance

表 5-2 日常维护 Table5-2 Routine maintenance

序号 NUM	检测项目 Check items	检验方法 Check methods	故障解决方法 Solution
1	电源线牢固性 Power line firm	1、关闭热交换器输入电源。 Turn off the supply power 2、用手拉动电源线，观察是否有松脱现象。 Pulled the power line, watch whether the line is loosening 3、用螺丝刀拧动电源线端子上的螺丝，观察是否有松动现象。 Screw the screws on the power cable terminals with a screwdriver, watch whether the screw is loosening	若发现有电源线有松脱或者松动现象，应重新用扎带绑紧电源线；用螺丝刀将松动的螺丝拧紧 If there is a power line loses, You should tie tightly power cable; with a screwdriver to the loose screw

2	供电电压稳定性 Voltage Stability	用万用表测量热交换器输入电压，观察用电压是否在正常范围内 Use the multimeter to measure heat exchanger input voltage to watch whether the voltage is within normal range.	若电压不在正常供电范围，请立刻关闭输入电源。直到输入电源稳定后才可再次运行热交换器。 If the voltage is not within the normal range, Please turn off the power supply immediately. Power on heat exchanger until the supply voltage within normal range.
3	安装螺丝牢固性 Screw firmly	用螺丝刀拧动热交换器的安装螺丝，观察是否有松动现象。 Use screwdriver to screw the screws and watch whether the screw is loosening	若有松动现象，则拧紧螺丝 If the screw is loosening, please tighten it.
4	系统运行 Cooling	系统断电后重新上电，观察热交换器自检程序是否正常， Power on the switch and watch whether the self-test is correct.	1、若发现自检过程中，有异常震动或声音，请立即关闭电源，并联系专业人士进行维护。 While self-testing, if there is abnormal noise, vibration, please cut off power immediately and notify the professionals to inspect. 2、自检过程中若发生告警，请根据告警代码进行处理。 If it is alarm while self-test, please process

● 日常维护步骤 Routine maintenance steps

建议热交换器的预防维护一年两次（取决于当地的地理位置和周围的环境），需完成以下几点：

It is recommended to perform preventive maintenance on the unit twice a year (depends on the location of the site and the nearby surroundings) and the following should be done:

1) 风扇运行时听风扇的声音。声音应该连续且有轻微的波动，否则风扇就失去平衡需要更换。

Listen to the fans while in operation. The sound should be constant and with very little fluctuation otherwise the fans are out of balance and should be replaced.

2) 关闭与热交换器连接的所有线路。

Switch all the circuit breakers related to the climate unit off.

3) 拆除内、外风扇。

Remove the internal and external fan.

4) 用毛刷、压缩空气和真空吸尘器清洁风扇的叶片。

Clean the blades of both fans using a brush, compressed air and a vacuum cleaner.

5) 使用小型毛刷、压缩空气和真空吸尘器清洁换热芯片，压缩空气的压力需小于 0.5bar.

Clean the heat transfer core using a small brush, compressed air and a vacuum cleaner, the air pressure should less than 0.5bar.

6) 将风扇装好。

Mount the fans back again.

7) 将开关打开。系统运行 30 秒，测试风扇以不同的转速运转是否正常。

Switch the unit ON again. This will activate the internal test program that runs for about 30 seconds, testing the fans at various speeds.

8) 结束。

Finish.

5.1.3 告警代码及处理方法 Alarm code and handling method

表 5-3 故障信息 Table 5-3 Alarm information

故障名称 Code Name	故障机制 Principle	故障处理方法 Process Method
回风温度传感器故障 Return air temperature sensor alarm	回风温度传感器短路或断路 Return air temperature sensor is short circuit or open circuit	检查回风温度传感器是否有断路或者短路现象。 Check whether the return air temperature sensor is short circuit or open circuit.
加热器欠流故障 Heater current is too low	加热器电流值不在正常范围内 Heater current is not within normal range	1、检查加热器线和加热器的连接是否松动。 Check whether the heater line is loosening 2、加热器本身故障，请联系专业人士维护。 Heater fault, please contact professional maintenance.
加热器过载故障 Heater over-current	加热器电流值不在正常范围 Compressor current is not within normal range	1、检查电压是否正常 Check whether the AC voltage is normal. 2、压缩机本身故障，请联系专业人士维护。 Compressor fault, please contact professional maintenance.
内风机告警 Internal fan alarm	内风机转速不在正常范围内 Internal fan current is not within normal range.	检查内风机线和内风机的连接是否脱落或松动 Check Whether the internal fan line is loosening.

外风机告警 External fan alarm	外风机转速不在正常范围内 External fan current is not within normal range.	检查外风机线和外风机的连接是否脱落或松动 Check Whether the external fan line is loosening.
-----------------------------	--	---

5.1.4 其他故障分析与处理 Other fault analysis and treatment

表 5-4 其他故障分析与处理 Table5-4 other fault analysis and processing

故障状态 Fault state	原因分析 Analysis of the reasons	故障排除方法 Solutions
电源接通后，柜内温度过高，但热交换器不运转 Power on the switch ,the cabinet temperature is too high but heat exchanger is not working	1、停电或无电源。 Power failure or no power 2、设备故障。 Machine fault	1、检查电源、电路。 Check the power supply and the electric circuit 2、请与专业维修人员联系 Please contact professional maintenance.
正常运转中。突然停止运行，且电器系统无故障。 The machine is stopping suddenly ,and the electric system is normal	1、柜内温度已达到设定温度。 The cabinet temperature greater than or equal to the cooling set temperature. 2、其他系统故障 Other system fault	1、 根据需要设定启动温度。 Setting start temperature according to the needs 2、 请与专业维修人员联系 Please contact professional maintenance.

5.2 售后服务和维修 Service and repair

● 保修期 Warranty period

产品质保 12 个月（从产品开始运行时起），或最大 18 个月（从产品发货日时起）。

The product guarantee period is 12 months from product up-running time or Max. 18 month from product delivery date.

● 质保范围 Warranty coverage

本产品在本保修期内，凡属于产品本身质量问题而导致故障的，本公司将为您免费维修，客户报修时需提供产品标号。但是由以下任何原因造成的故障不属于我司的保修范围。

- 1) 已超过保修期的；
- 2) 不能提供产品出厂编号的（见机身贴示的铭牌）；
- 3) 由于在异常条件或环境中运行，或者用非本使用说明书中指定的不恰当安装方式安装、维护或操作导致的故障；
- 4) 非本设备造成的故障，比如由用户的设备、用户的软件等造成的故障；
- 5) 用户自行更换或拆装产品零部件造成损坏的，或由非授权维修服务者拆修而造成损坏的；

6) 诸如火灾、地震、洪水等不可抗力而造成损坏的故障。

During the warranty period, all belong to the product itself quality problems caused by fault, the company will be free for you to repair; Household repair is required to provide the product label. But by any of the following causes the failure does not belong to our warranty.

- 1) Out of the Warranty period
- 2) Cannot provide the product label(the product label is on the nameplate);
- 3) Because of the abnormal condition or environment ,or the instructions specified in the inappropriate installation, maintenance or operation causes the fault;
- 4) Not caused by equipment failure, caused by user's other equipment or software.
- 5) User changed or disassembles by theirself, or maintained by the person without authorization.
- 6) Caused by force major such as fires, earthquakes, floods and other damage to the fault.

免责声明 Disclaim

我司的保修仅限于已发送的产品。我司对可能由设备故障衍生的任何损失不负责任。

The warranty is for the delivered products.

Irresponsible is for any loss that may be caused by equipment failure.

5.3 回收处理 Reclaim



到本产品使用期限或不再使用该产品时，请勿将本产品直接作为垃圾处理，请交给当地政府认可的废物收集中心进行处理。

At the end of the unit working life, the produce must not be disposed of as urban waste; it must be taken to a special local authority differentiated waste collection centre or to a dealer providing this service.



酷 | 克
QUICK

Suzhou Quik Thermal Control Technology Co.Ltd

苏州酷克温控科技有限公司

No.15 Xiangpu Rd Suzhou Industrial Park Suzhou China

中国 · 苏州 · 工业园区 · 翔浦路 15 号

Tel: +86 512 65335116