

**NORME  
INTERNATIONALE  
INTERNATIONAL  
STANDARD**

**CEI  
IEC  
60825-2**

**Edition 3.1**

2007-01

Edition 3:2004 consolidée par l'amendement 1:2006  
Edition 3:2004 consolidated with amendment 1:2006

---

---

**Sécurité des appareils à laser –**

**Partie 2:  
Sécurité des systèmes de télécommunication  
par fibres optiques (STFO)**

**Safety of laser products –**

**Part 2:  
Safety of optical fibre communication  
systems (OFCS)**



Numéro de référence  
Reference number  
CEI/IEC 60825-2:2004+A1:2006

## Numérotation des publications

Depuis le 1er janvier 1997, les publications de la CEI sont numérotées à partir de 60000. Ainsi, la CEI 34-1 devient la CEI 60034-1.

## Editions consolidées

Les versions consolidées de certaines publications de la CEI incorporant les amendements sont disponibles. Par exemple, les numéros d'édition 1.0, 1.1 et 1.2 indiquent respectivement la publication de base, la publication de base incorporant l'amendement 1, et la publication de base incorporant les amendements 1 et 2.

## Informations supplémentaires sur les publications de la CEI

Le contenu technique des publications de la CEI est constamment revu par la CEI afin qu'il reflète l'état actuel de la technique. Des renseignements relatifs à cette publication, y compris sa validité, sont disponibles dans le Catalogue des publications de la CEI (voir ci-dessous) en plus des nouvelles éditions, amendements et corrigenda. Des informations sur les sujets à l'étude et l'avancement des travaux entrepris par le comité d'études qui a élaboré cette publication, ainsi que la liste des publications parues, sont également disponibles par l'intermédiaire de:

- **Site web de la CEI ([www.iec.ch](http://www.iec.ch))**
- **Catalogue des publications de la CEI**

Le catalogue en ligne sur le site web de la CEI ([www.iec.ch/searchpub](http://www.iec.ch/searchpub)) vous permet de faire des recherches en utilisant de nombreux critères, comprenant des recherches textuelles, par comité d'études ou date de publication. Des informations en ligne sont également disponibles sur les nouvelles publications, les publications remplacées ou retirées, ainsi que sur les corrigenda.

- **IEC Just Published**

Ce résumé des dernières publications parues ([www.iec.ch/online\\_news/justpub](http://www.iec.ch/online_news/justpub)) est aussi disponible par courrier électronique. Veuillez prendre contact avec le Service client (voir ci-dessous) pour plus d'informations.

- **Service clients**

Si vous avez des questions au sujet de cette publication ou avez besoin de renseignements supplémentaires, prenez contact avec le Service clients:

Email: [custserv@iec.ch](mailto:custserv@iec.ch)  
Tél: +41 22 919 02 11  
Fax: +41 22 919 03 00

## Publication numbering

As from 1 January 1997 all IEC publications are issued with a designation in the 60000 series. For example, IEC 34-1 is now referred to as IEC 60034-1.

## Consolidated editions

The IEC is now publishing consolidated versions of its publications. For example, edition numbers 1.0, 1.1 and 1.2 refer, respectively, to the base publication, the base publication incorporating amendment 1 and the base publication incorporating amendments 1 and 2.

## Further information on IEC publications

The technical content of IEC publications is kept under constant review by the IEC, thus ensuring that the content reflects current technology. Information relating to this publication, including its validity, is available in the IEC Catalogue of publications (see below) in addition to new editions, amendments and corrigenda. Information on the subjects under consideration and work in progress undertaken by the technical committee which has prepared this publication, as well as the list of publications issued, is also available from the following:

- **IEC Web Site ([www.iec.ch](http://www.iec.ch))**
- **Catalogue of IEC publications**

The on-line catalogue on the IEC web site ([www.iec.ch/searchpub](http://www.iec.ch/searchpub)) enables you to search by a variety of criteria including text searches, technical committees and date of publication. On-line information is also available on recently issued publications, withdrawn and replaced publications, as well as corrigenda.

- **IEC Just Published**

This summary of recently issued publications ([www.iec.ch/online\\_news/justpub](http://www.iec.ch/online_news/justpub)) is also available by email. Please contact the Customer Service Centre (see below) for further information.

- **Customer Service Centre**

If you have any questions regarding this publication or need further assistance, please contact the Customer Service Centre:

Email: [custserv@iec.ch](mailto:custserv@iec.ch)  
Tel: +41 22 919 02 11  
Fax: +41 22 919 03 00

**NORME  
INTERNATIONALE  
INTERNATIONAL  
STANDARD**

**CEI  
IEC**

**60825-2**

**Edition 3.1**

2007-01

Edition 3:2004 consolidée par l'amendement 1:2006  
Edition 3:2004 consolidated with amendment 1:2006

---

---

**Sécurité des appareils à laser –**

**Partie 2:  
Sécurité des systèmes de télécommunication  
par fibres optiques (STFO)**

**Safety of laser products –**

**Part 2:  
Safety of optical fibre communication  
systems (OFCS)**

© IEC 2007 Droits de reproduction réservés — Copyright - all rights reserved

Aucune partie de cette publication ne peut être reproduite ni utilisée sous quelque forme que ce soit et par aucun procédé, électronique ou mécanique, y compris la photocopie et les microfilms, sans l'accord écrit de l'éditeur.

No part of this publication may be reproduced or utilized in any form or by any means, electronic or mechanical, including photocopying and microfilm, without permission in writing from the publisher.

International Electrotechnical Commission, 3, rue de Varembe, PO Box 131, CH-1211 Geneva 20, Switzerland  
Telephone: +41 22 919 02 11 Telefax: +41 22 919 03 00 E-mail: [inmail@iec.ch](mailto:inmail@iec.ch) Web: [www.iec.ch](http://www.iec.ch)

---

---



Commission Electrotechnique Internationale  
International Electrotechnical Commission  
Международная Электротехническая Комиссия

CODE PRIX  
PRICE CODE

**XA**

*Pour prix, voir catalogue en vigueur  
For price, see current catalogue*

## CONTENTS

FOREWORD.....	7
1 Scope and object.....	11
2 Normative references .....	13
3 Terms and definitions .....	13
4 Requirements .....	19
4.1 General.....	19
4.2 Protective housing of OFCS .....	21
4.3 Fibre cables .....	21
4.4 Cable connectors .....	21
4.5 Automatic power reduction (APR) and restart pulses .....	23
4.6 Labelling or marking.....	25
4.7 Organizational requirements.....	35
4.8 Assessment of hazard level.....	37
4.9 Hazard level requirements by location type .....	39
Annex A (informative) Rationale .....	43
Annex B (informative) Summary of requirements at locations in OFCS .....	45
Annex C (informative) Methods of hazard/safety analysis .....	47
Annex D (informative) Application notes for the safe use of OFCS.....	49
Annex E (informative) Guidance for service and maintenance.....	101
Annex F (informative) Clarification of the meaning of “hazard level”.....	107
Bibliography.....	111
Figure D.1 – PON (passive optical network)-based system .....	69
Figure D.2 – Simple laser drive circuit.....	73
Figure D.3 – Risk graph example from IEC 61508-5 Clause D.5 .....	81
Figure D.4 – Graph of FIT rate and mean time to repair .....	87
Table 1 – Marking in unrestricted locations .....	27
Table 2 – Marking in Restricted Locations.....	29
Table 3 – Marking in controlled locations .....	31
Table D.1 – OFCS power limits for 11 µm single mode (SM) fibres and 0,18 numerical aperture multimode (MM) fibres (core diameter < 150 µm) .....	53
Table D.2 – Relation between the number of fibres in a ribbon fibre and the maximum permitted power (example) .....	67
Table D.3 – Identification of components and failure modes (example) .....	75
Table D.4 – Beta values (example) .....	75

Table D.5 – Determination of failure rates (example) ..... 77

Table D.6 – Consequence classification from IEC 61508-5 Table D.1 ..... 81

Table D.7 – Frequency classification from IEC 61508-5 Table D.1 ..... 83

Table D.8 – Possibility of avoiding hazard classification from IEC 61508-5 Table D.1 ..... 83

Table D.9 – Classification of the probability of the unwanted occurrence  
from IEC 61508-5 Table D.1 ..... 83

Table D.10 – Modes of operation – Definitions from IEC 61508-4, 3.5.12 ..... 85

Table D.11 – SIL Values from 7.6.2.9 of IEC 61508-1 ..... 85

Table D.12 – Determination of equipment monitoring classification ..... 89

Table D.13 – FIT rates from example above..... 91

Table D.14 – Examples of power limits for optical fibre communication systems  
having automatic power reduction to reduce emissions to a lower hazard level..... 99

## INTERNATIONAL ELECTROTECHNICAL COMMISSION

## SAFETY OF LASER PRODUCTS –

**Part 2: Safety of optical fibre communication systems (OFCS)**

## FOREWORD

- 1) The International Electrotechnical Commission (IEC) is a worldwide organization for standardization comprising all national electrotechnical committees (IEC National Committees). The object of IEC is to promote international co-operation on all questions concerning standardization in the electrical and electronic fields. To this end and in addition to other activities, IEC publishes International Standards, Technical Specifications, Technical Reports, Publicly Available Specifications (PAS) and Guides (hereafter referred to as "IEC Publication(s)"). Their preparation is entrusted to technical committees; any IEC National Committee interested in the subject dealt with may participate in this preparatory work. International, governmental and non-governmental organizations liaising with the IEC also participate in this preparation. IEC collaborates closely with the International Organization for Standardization (ISO) in accordance with conditions determined by agreement between the two organizations.
- 2) The formal decisions or agreements of IEC on technical matters express, as nearly as possible, an international consensus of opinion on the relevant subjects since each technical committee has representation from all interested IEC National Committees.
- 3) IEC Publications have the form of recommendations for international use and are accepted by IEC National Committees in that sense. While all reasonable efforts are made to ensure that the technical content of IEC Publications is accurate, IEC cannot be held responsible for the way in which they are used or for any misinterpretation by any end user.
- 4) In order to promote international uniformity, IEC National Committees undertake to apply IEC Publications transparently to the maximum extent possible in their national and regional publications. Any divergence between any IEC Publication and the corresponding national or regional publication shall be clearly indicated in the latter.
- 5) IEC provides no marking procedure to indicate its approval and cannot be rendered responsible for any equipment declared to be in conformity with an IEC Publication.
- 6) All users should ensure that they have the latest edition of this publication.
- 7) No liability shall attach to IEC or its directors, employees, servants or agents including individual experts and members of its technical committees and IEC National Committees for any personal injury, property damage or other damage of any nature whatsoever, whether direct or indirect, or for costs (including legal fees) and expenses arising out of the publication, use of, or reliance upon, this IEC Publication or any other IEC Publications.
- 8) Attention is drawn to the Normative references cited in this publication. Use of the referenced publications is indispensable for the correct application of this publication.
- 9) Attention is drawn to the possibility that some of the elements of this IEC Publication may be the subject of patent rights. IEC shall not be held responsible for identifying any or all such patent rights.

International Standard IEC 60825-2 has been prepared by IEC technical committee 76: Optical radiation safety and laser equipment

This third edition cancels and replaces the second edition published in 2000. It constitutes a technical revision to bring the hazard level nomenclature used in this document into correspondence with the revised classification system introduced in IEC 60825-1(2001). Additionally, the standard has been thoroughly revised throughout.

This consolidated version of IEC 60825-2 is based on the third edition (2004) [documents 76/288/FDIS and 76/293/RVD] and its amendment 1 (2006) [documents 76/346/FDIS and 76/353/RVD].

It bears the edition number 3.1.

A vertical line in the margin shows where the base publication has been modified by amendment 1.

The French version of this standard has not been voted upon.

This publication has been drafted in accordance with the ISO/IEC Directives, Part 2.

IEC 60825 consists of the following parts, under the general title *Safety of laser products*:

- Part 1: Equipment classification, requirements and user's guide
- Part 2: Safety of optical fibre communication systems (OFCS)
- Part 3: Guidance for laser displays and shows
- Part 4: Laser guards
- Part 5: Manufacturer's checklist for IEC 60825-1
- Part 6: Safety of products with optical sources, exclusively used for visible information transmission to the human eye
- Part 7: Safety of products emitting infrared optical radiation, exclusively used for wireless 'free air' data transmission and surveillance
- Part 8: Guidelines for the safe use of medical laser equipment
- Part 9: Compilation of maximum permissible exposure to incoherent optical radiation
- Part 10: Application guidelines and explanatory notes to IEC 60825-1
- Part 12: Safety of free space optical communication systems used for transmission of information
- Part 14: A user's guide

The committee has decided that the contents of the base publication and its amendments will remain unchanged until the maintenance result date indicated on the IEC web site under "<http://webstore.iec.ch>" in the data related to the specific publication. At this date, the publication will be

- reconfirmed,
- withdrawn,
- replaced by a revised edition, or
- amended.

## SAFETY OF LASER PRODUCTS –

### Part 2: Safety of optical fibre communication systems (OFCS)

#### 1 Scope and object

This Part 2 of IEC 60825 provides requirements and specific guidance for the safe operation and maintenance of optical fibre communication systems (OFCS). In these systems optical power may be accessible outside the confinements of transmitting equipment or at great distance from the optical source.

This Part 2 requires the assessment of hazard levels at accessible locations as a replacement for classification according to IEC 60825-1. It applies to the complete installed end-to-end OFCS, including its components and subassemblies that generate or amplify optical radiation. Individual components and subassemblies that are sold only to OEM vendors for incorporation into a complete installed end-to-end OFCS need not be assessed to this standard, since the final OFCS should itself be assessed according to this standard.

NOTE The above statement is not intended to prevent manufacturers of such components and subassemblies from using this standard if they wish to do so, or are required to do so by contract.

This standard does not apply to optical fibre systems primarily designed to transmit optical power for applications such as material processing or medical treatment.

In addition to the hazards resulting from laser radiation, OFCS may also give rise to other hazards, such as fire.

This standard does not address safety issues associated with explosion or fire with respect to OFCS deployed in explosive atmospheres.

Throughout this part of IEC 60825, a reference to 'laser' is taken to include light-emitting diodes (LEDs) and optical amplifiers.

The objective of this Part 2 of IEC 60825 is to:

- protect people from optical radiation resulting from OFCS;
- provide requirements for manufacturers, installation organizations, service organizations and operating organizations in order to establish procedures and supply information so that proper precautions can be adopted;
- ensure adequate warnings are provided to individuals regarding the potential hazards associated with OFCS through the use of signs, labels and instructions.

Annex A gives a more detailed rationale for this part of IEC 60825.

The safety of an OFCS depends to a significant degree on the characteristics of the equipment forming that system. Depending on the characteristics of the equipment, it may be necessary to mark safety relevant information on the product or include it within the instructions for use.



Where required by the level of potential hazard, it places the responsibility for the safe deployment and use of these systems on the installer or end-user / operating organization or both. This standard places the responsibility for adherence to safety instructions during installation and service operations on the installation organization and service organizations as appropriate, and operation and maintenance functions on the end-user or operating organization. It is recognised that the user of this standard may fall into one or more of the aforementioned categories of manufacturer, installation organization, end-user or operating organization.

## 2 Normative references

The following referenced documents are indispensable for the application of this document. For dated references, only the edition cited applies. For undated references, the latest edition of the referenced document (including any amendments) applies.

IEC 60825-1, *Safety of laser products – Part 1: Equipment classification, requirements and user's guide*<sup>1)</sup>

Amendment 1 (1997)

Amendment 2 (2001)

## 3 Terms and definitions

For the purposes of this document, the terms and definitions contained in IEC 60825-1 as well as the following terms and definitions apply.

### 3.1

#### **accessible location**

any part or location within an OFCS at which, under reasonably foreseeable events, human access to laser radiation is possible without the use of a tool

### 3.2

#### **automatic power reduction (APR)**

a feature of an OFCS by which the accessible power is reduced to a specified level within a specified time, whenever there is an event which could result in human exposure to radiation, e.g. a fibre cable break

NOTE The term “automatic power reduction” (APR) used in this standard encompasses the following terms used in recommendations of the International Telecommunication Union ITU:

- automatic laser shutdown (ALS);
- automatic power reduction (APR);
- automatic power shutdown (APSD).

### 3.3

#### **end-user**

person or organization using the OFCS in the manner the system was designed to be used

NOTE 1 The end-user cannot necessarily control the power generated and transmitted within the system.

---

<sup>1)</sup> A consolidated edition 1.2 exists including IEC 60825-1 (1993) and its Amendment 1 (1997) and Amendment 2 (2001).

NOTE 2 If the person or organization is using the OFCS for a communications application in a manner other than as designed by the manufacturer, then that person/organization assumes the responsibilities of a manufacturer or installation organization.

### **3.4**

#### **hazard level**

the potential hazard at any accessible location within an OFCS. It is based on the level of optical radiation which could become accessible in a reasonably foreseeable event, e.g. a fibre cable break. It is closely related to the laser classification procedure in IEC 60825-1

### **3.5**

#### **hazard level 1**

hazard level 1 is assigned to any accessible location within an OFCS at which, under reasonably foreseeable events, human access to laser radiation in excess of the accessible emission limits of Class 1 for the applicable wavelengths and emission duration will not occur

### **3.6**

#### **hazard level 1M**

hazard level 1M is assigned to any accessible location within an OFCS at which, under a reasonably foreseeable event, human access to laser radiation in excess of the accessible emission limits of Class 1 for the applicable wavelengths and emission duration will not occur, whereby the level of radiation is measured with the measurement conditions for Class 1M laser products (see IEC 60825-1)

NOTE If the applicable limit of hazard level 1M is larger than the limit of 2 or 3R and less than the limit of 3B, hazard level 1M is allocated.

### **3.7**

#### **hazard level 2**

hazard level 2 is assigned to any accessible location within an OFCS at which, under a reasonably foreseeable event, human access to laser radiation in excess of the accessible emission limits of Class 2 for the applicable wavelengths and emission duration will not occur

NOTE If the applicable limit of hazard level 1M is larger than the limit of 2 and less than the limit of 3B, hazard level 1M is allocated.

### **3.8**

#### **hazard level 2M**

hazard level 2M is assigned to any accessible location within an OFCS at which, under a reasonably foreseeable event, human access to laser radiation in excess of the accessible emission limits of Class 2 for the applicable wavelengths and emission duration will not occur, whereby the level of radiation is measured with the measurement conditions for Class 2M laser products (see IEC 60825-1)

NOTE If the applicable limit of hazard level 2M is larger than the limit of 3R and less than the limit of 3B, hazard level 2M is allocated.

### **3.9**

#### **hazard level 3R**

hazard level 3R is assigned to any accessible location within an OFCS at which, under a reasonably foreseeable event, human access to laser radiation in excess of the accessible emission limits of Class 3R for the applicable wavelengths and emission duration will not occur

NOTE If the applicable limit of hazard level 1M or 2M is larger than the limit of 3R and less than the limit of 3B, hazard level 1M or 2M is allocated.

**3.10****hazard level 3B**

hazard level 3B is assigned to any accessible location within an OFCS at which, under a reasonably foreseeable event, human access to laser radiation in excess of the accessible emission limits of Class 3B for the applicable wavelengths and emission duration will not occur

**3.11****hazard level 4**

hazard level 4 is assigned to any accessible location within an OFCS at which, under a reasonably foreseeable event, human access to laser radiation in excess of the accessible emission limits of Class 3B for the applicable wavelengths and emission duration may occur

NOTE This standard is applicable for the operation and maintenance of OFCS. In order to achieve an adequate level of safety for persons who may come into contact with the optical transmission path, hazard level 4 is not permitted within this standard. It is permitted to use protection systems, such as automatic power reduction, to achieve the required hazard level where the transmitted power under normal operating conditions (e.g. no fault exists in the fibre path) exceeds that permitted for a particular location type. For instance, it is possible for accessible parts of an OFCS to be hazard level 1 even though the power transmitted down the fibre under normal operating conditions is Class 4.

**3.12****installation organization**

an organization or individual that is responsible for the installation of an OFCS

**3.13****location with controlled access; controlled location**

an accessible location where an engineering or administrative control is present to make it inaccessible, except to authorized personnel with appropriate laser safety training

NOTE For examples see D.2.1 a).

**3.14****location with restricted access; restricted location**

an accessible location that is normally inaccessible by the general public by means of any administrative or engineering control measure but that is accessible to authorized personnel who may not have laser safety training

NOTE For examples see D.2.1 b).

**3.15****location with unrestricted access; unrestricted location**

an accessible location where there are no measures restricting access to members of the general public

NOTE For examples see D.2.1 c).

**3.16****manufacturer**

organization or individual that assembles optical devices and other components in order to construct or modify an OFCS

**3.17****operating organization**

organization or individual that is responsible for the operation of an OFCS

**3.18****optical fibre communication system (OFCS)**

an engineered, end-to-end assembly for the generation, transfer and reception of optical radiation arising from lasers, LEDs or optical amplifiers, in which the transference is by means of optical fibre for communication and/or control purposes

**3.19****reasonably foreseeable event**

an event the occurrence of which under given circumstances can be predicted fairly accurately, and the occurrence probability or frequency of which is not low or very low

NOTE Examples of reasonably foreseeable events might include the following: fibre cable break, optical connector disconnection, operator error or inattention to safe working practices.

Reckless use or use for completely inappropriate purposes is not considered as a reasonably foreseeable event.

**3.20****service organization**

an organization or individual that is responsible for the servicing of an OFCS

**3.21****subassembly**

any discrete unit, subsystem, network element, or module of an OFCS which contains an optical emitter or optical amplifier

**4 Requirements****4.1 General**

This section defines the restrictions that are to be placed on an OFCS and on the location types in which an OFCS can operate, in accordance with the hazard that arises from optical radiation becoming accessible as a result of a reasonably foreseeable event. Whenever one or more alterations are made to an OFCS, the organization responsible for that alteration shall make a determination of whether each alteration could affect the hazard level. If the hazard level has changed, the organization responsible for the alteration(s) shall re-label those locations in the system that are accessible so as to ensure continued compliance with this standard.

Each accessible location within an OFCS shall be separately assessed to determine the hazard level at that location. Where multiple communications systems are present at a location, the hazard level for the location shall be the highest of the levels arising from each of those systems. Based on the hazard level determined, appropriate actions shall be taken to ensure compliance with this standard. These actions could for example involve restriction of access to the location, or the implementation of safety features or redesign of the optical communications system to reduce the hazard level.

Suppliers of active components and subassemblies in conformance with this standard that do not comprise an OFCS need to comply only with the applicable portions of Clause 4.

OFCS that also transmit electrical power shall meet the requirements of this standard in addition to any applicable electrical standard.

NOTE When determining the hazard level, two characteristics have to be taken into account.

1) What is the maximum permissible exposure (MPE)? The level of exposure must be determined at a location where it is reasonably foreseeable that a person could be exposed to radiation coming from the OFCS. The time taken for the APR system (if present) to operate must be included when determining the MPE. If the OFCS does not incorporate APR, then meeting the requirements referred to in Note 2 below will be taken as automatically meeting the requirements of this Note 1 without further investigation or tests. Requirements are described in 4.8.2.

2) What is the maximum permitted power at which the OFCS can operate after a reasonable foreseeable event (such as a fibre-break) has caused the radiation to become accessible? This maximum power value could be lower than the normal operating power in the fibre as a result of activation of the APR system. Requirements are described in 4.8.1.

## 4.2 Protective housing of OFCS

Each OFCS shall have a protective housing which, when in place, prevents human access to laser radiation in excess of hazard level 1 limits under normal operating conditions.

## 4.3 Fibre cables

If the potential hazard at any accessible location within an OFCS is hazard level 1M, 2M, 3R or 3B, then the fibre optic cable shall have mechanical properties appropriate to its physical location. Cables for various physical locations are described in the IEC 60794 series. Where necessary, additional protection, for example ducting, conduit or raceway, may be required for locations where the fibre would otherwise be susceptible to damage.

## 4.4 Cable connectors

The following requirements for cable connectors may be achieved by the mechanical design of the connectors, or by the positioning of the connector, or by any other suitable means. Whichever means is chosen, human access to radiation above that permitted for connectors in a particular location type shall be prevented.

NOTE The use of a tool for disconnection is one example of a mechanical solution.

### 4.4.1 Unrestricted locations

In unrestricted locations, if the accessible radiation level exceeds:

- hazard level 2 within the wavelength range 400 nm to 700 nm, or
- hazard level 1 in all other cases,

then suitable means shall limit access to the radiation from the connector.

NOTE In an unrestricted location the highest hazard levels permitted are hazard level 2M for the wavelength range 400 nm to 700 nm and hazard level 1M in all other cases (see 4.9.1)

### 4.4.2 Restricted locations

In restricted locations, if the accessible radiation level exceeds:

- hazard level 2M within the wavelength range 400 nm to 700 nm, or
- hazard level 1M in all other cases,

then suitable means shall limit access to the radiation from the connector.

NOTE In a restricted location the highest hazard level permitted is hazard level 1M, 2M or 3R, whichever is the higher (see 4.9.2).

#### **4.4.3 Controlled locations**

In controlled locations, if the accessible radiation level exceeds:

- hazard level 2M within the wavelength range 400 nm to 700 nm, or
- hazard level 1M in all other cases,

then suitable means shall limit access to the radiation from the connector.

NOTE In a controlled location the highest hazard level permitted is hazard level 3B (see 4.9.3).

#### **4.5 Automatic power reduction (APR) and restart pulses**

If equipment makes use of an automatic power reduction (APR) system in order to reduce its assigned hazard level, then it shall be restarted with restrictions which are described in the following three scenarios. In addition, the APR shall be designed to have an adequate level of reliability (see Note 1).

NOTE 1 Examples of calculating the reliability of APR systems are given in Clause D.5.

NOTE 2 The restart interval described in the following scenarios is wavelength-dependent as described in IEC 60825-1.

##### **4.5.1 Automatic restart**

In the case where the restart is initiated automatically, the timing and power of the restart process shall be restricted such that the hazard level assigned to each accessible location of the system shall not be exceeded.

##### **4.5.2 Manual restart with assured continuity**

In the case where the restart is initiated manually and the continuity of the communications path is assured by the use of administrative controls or other means, the timing and power of the restart process is not restricted (see Note 3). The manufacturer's instructions shall specify that administrative controls (or other means) must take account of the fact that the assigned hazard level at any accessible location may be exceeded during this restart procedure.

NOTE 3 Since in this case the timing and power of the restart process is not restricted, the administrative or other controls will need to take into consideration any increased risk of new hazards (such as fire). It is important that these additional controls be documented in the appropriate service instructions.

##### **4.5.3 Manual restart without assured continuity**

In the case where the restart is initiated manually and the continuity of the communications path is not assured, the timing and power of the restart process shall be restricted such that the hazard level assigned to each accessible location of the system shall not be exceeded.

##### **4.5.4 Disabling of the APR**

If a manual initiated restart of the system temporarily inactivates the APR, the system must indicate that the APR is not operable for the duration of the reboot so that the operating organization can take the appropriate precautions. Unless these conditions are met, the hazard level must be assigned using the transmitting power level before APR.

Disabling of the APR mechanism shall not be permitted for Class 3B and 4 transmitting powers, unless all of the following conditions are met:

- 1) that such disabling is necessary only for the infrequent incidences of system installation and service;
- 2) that such disabling can only be done via software commands or a manual lockout key system;
- 3) if disabling is done via software commands, incorporated in such software shall be a security system that prevents inadvertent disabling of the APR mechanism;
- 4) that such software incorporate a warning indicator that the APR will be disabled if the procedure is continued;
- 5) continuous operation of the traffic-carrying OFCS with APR disabled shall be prevented by suitable engineering means;
- 6) proper instructions on the safe use of the equipment with the disabled APR are included in the documentation.

NOTE 1 Except where otherwise explicitly stated, this standard does not permit end-to-end OFCS to operate if accessible locations within that system are hazard level 4. If the transmitting power of a transmitter, amplifier, etc. is Class 4 and the APR has been disabled, then the result would be accessible locations operating at hazard level 4. Nevertheless, it is recognised that it may be necessary to disable the APR in certain conditions, but these conditions need to be well controlled and time-limited so that the probability of exposure to a Class 4 radiation is very low.

NOTE 2 Regarding condition 5), an example of a 'suitable engineering means' is a control system that automatically re-enables the APR as soon as practicable after a time interval that is long enough to complete whatever task that caused the APR to be initially deactivated.

## **4.6 Labelling or marking**

### **4.6.1 General requirements**

Where required by this subclause, each optical connector, splice box or other part emitting radiation when opened shall be marked (e.g. with a label, sleeve, tag, tape etc.), if the hazard level at the location is in excess of hazard level 1. The information shall consist of the information identified in Tables 1, 2 or 3 as applicable.

Where the accessible radiation at points of disconnection is hazard level 1 or hazard level 1M it is permitted for the above information to be provided in information for the user instead of as a marking on the product.

Markings shall be coloured black on a yellow background. Labels reproduced in the documentation provided by the manufacturer or by the operating organisation are permitted to use black on a white background.

It is acceptable to reduce the marking in size, providing that the result is legible. For subassemblies containing lasers or optical amplifiers, it is the responsibility of the manufacturer of the subassembly to provide such labelling; all other labelling is the responsibility of the operating organization.

Except as permitted below, each optical connector, splice box or other part that is intended to permit access to optical radiation when opened shall be marked (e.g. with a label, sleeve, tag, tape etc.) in accordance with Tables 1, 2 or 3, as applicable.

In addition to the marking required in this Part 2, certain subassemblies may also need to be marked because of their stand-alone application under Part 1, and in such situations it is left to the manufacturer of the OFCS whether they supplement the marking required by Part 1 or replace it with the marking as required by Part 2.

**Table 1 – Marking in unrestricted locations**











Accessible hazard level	Required marking - Unrestricted location
1	No marking required
1M	No marking required <sup>a)</sup>
2	<div style="display: flex; align-items: center; justify-content: space-between;"> <div style="text-align: center;">  <p><sup>b)</sup></p> </div> <div style="border: 2px solid black; border-radius: 15px; padding: 10px; text-align: center;"> <p><sup>e)</sup></p> <p><b>CAUTION</b></p> <p>HAZARD LEVEL 2 LASER <sup>c)</sup> RADIATION <sup>d)</sup></p> <p>DO NOT STARE INTO BEAM</p> </div> </div>
2M	<div style="display: flex; align-items: center; justify-content: space-between;"> <div style="text-align: center;">  <p><sup>b)</sup></p> </div> <div style="border: 2px solid black; border-radius: 15px; padding: 10px; text-align: center;"> <p><sup>e)</sup></p> <p><b>CAUTION</b></p> <p>HAZARD LEVEL 2M LASER <sup>c)</sup> RADIATION <sup>d)</sup></p> <p>DO NOT STARE INTO THE BEAM OR VIEW DIRECTLY WITH NON-ATTENUATING OPTICAL INSTRUMENTS</p> </div> </div>
3R	Not permitted
3B	Not permitted
NOTE See 4.6.5 regarding invisible laser beam hazards.	
<p>Conditions applicable to the above table:</p> <p><sup>a</sup> Subclause 4.4.1 requires access to radiation from a connector to be limited to hazard level 1 by a suitable means and the mechanical design of the fibre cables must be consistent with the relevant standard within the IEC 60794 series (see 4.3). Therefore, hazard level 1M is exempt from marking requirements.</p> <p><sup>b</sup> Hazard symbol warning label according to IEC 60825-1, Figure 14.</p> <p><sup>c</sup> Where the source of the radiation is a light emitting diode, the word "Laser" above shall be replaced by "LED".</p> <p><sup>d</sup> Replacing the word "Radiation" with "Light" for radiation in the range 400 nm to 700 nm is optional.</p> <p><sup>e</sup> Explanatory label (outline) according to IEC 60825-1, Figure 15. It is permitted for this outline to also encompass the hazard symbol according to IEC 60825-1, Figure 14.</p>	



Table 2 – Marking in Restricted Locations

Accessible hazard level	Required Marking - Restricted Location
1	No marking required
1M	Marking required only for those cases where the requirements for cable connectors in unrestricted locations are not met (see 4.4.1), but also see note 2 below: <div style="display: flex; align-items: center; justify-content: center; gap: 20px;"> <div style="text-align: center;">  <p>a)</p> </div> <div style="border: 2px solid black; border-radius: 15px; padding: 10px; text-align: center;"> <p><b>CAUTION</b></p> <p>HAZARD LEVEL 1M LASER <sup>b)</sup> RADIATION <sup>c)</sup></p> <p>DO NOT VIEW DIRECTLY WITH NON-ATTENUATING OPTICAL INSTRUMENTS</p> </div> <div style="text-align: right;"> <p>d)</p> </div> </div>
2	<div style="display: flex; align-items: center; justify-content: center; gap: 20px;"> <div style="text-align: center;">  <p>a)</p> </div> <div style="border: 2px solid black; border-radius: 15px; padding: 10px; text-align: center;"> <p><b>CAUTION</b></p> <p>HAZARD LEVEL 2 LASER <sup>b)</sup> RADIATION <sup>c)</sup></p> <p>DO NOT STARE INTO BEAM</p> </div> <div style="text-align: right;"> <p>d)</p> </div> </div>
2M	<div style="display: flex; align-items: center; justify-content: center; gap: 20px;"> <div style="text-align: center;">  <p>a)</p> </div> <div style="border: 2px solid black; border-radius: 15px; padding: 10px; text-align: center;"> <p><b>CAUTION</b></p> <p>HAZARD LEVEL 2M LASER <sup>b)</sup> RADIATION <sup>c)</sup></p> <p>DO NOT STARE INTO THE BEAM OR VIEW DIRECTLY WITH NON-ATTENUATING OPTICAL INSTRUMENTS</p> </div> <div style="text-align: right;"> <p>d)</p> </div> </div>
3R	<div style="display: flex; align-items: center; justify-content: center; gap: 20px;"> <div style="text-align: center;">  <p>a)</p> </div> <div style="border: 2px solid black; border-radius: 15px; padding: 10px; text-align: center;"> <p><b>CAUTION</b></p> <p>HAZARD LEVEL 3R LASER <sup>b)</sup> RADIATION <sup>c)</sup></p> <p>AVOID EXPOSURE TO THE BEAM</p> </div> <div style="text-align: right;"> <p>d)</p> </div> </div>
3B	Not permitted.
NOTE 1 Unlike the labelling requirements of 5.8 of IEC 60825-1, marking in restricted locations is mandatory for locations with hazard level 1M, except as identified above.	
NOTE 2 Where the accessible radiation at points of disconnection is hazard level 1 or hazard level 1M, it is permitted for this to be noted in information for the user instead of as a marking on (e.g.) the product, fibre or connector.	
NOTE 3 See 4.6.5 regarding invisible laser beam hazards.	
Conditions applicable to the above table: <ul style="list-style-type: none"> <li>a) Warning label according to IEC 60825-1, Figure 14.</li> <li>b) Where the source of the radiation is a light emitting diode, the word "Laser" above shall be replaced by "LED".</li> <li>c) If the radiation is in the range 400 nm to 700 nm it is optional to replace the word "Radiation" with "Light".</li> <li>d) Explanatory label (outline) according to Figure 15 of IEC 60825-1. It is permitted for this outline to also encompass the hazard symbol according to Figure 14 of IEC 60825-1.</li> </ul>	

**Table 3 – Marking in controlled locations**

Accessible hazard level	Required Marking - Controlled Location
1	No marking required
1M	No marking required <sup>e)</sup>
2	<div style="display: flex; align-items: center; justify-content: space-around;"> <div style="text-align: center;"> <sup>a)</sup>   </div> <div style="border: 2px solid black; border-radius: 15px; padding: 10px; text-align: center;"> <sup>d)</sup>            CAUTION            HAZARD LEVEL 2 LASER <sup>b)</sup> RADIATION <sup>c)</sup>            DO NOT STARE INTO BEAM         </div> </div>
2M	<div style="display: flex; align-items: center; justify-content: space-around;"> <div style="text-align: center;"> <sup>a)</sup>   </div> <div style="border: 2px solid black; border-radius: 15px; padding: 10px; text-align: center;"> <sup>d)</sup>            CAUTION            HAZARD LEVEL 2M LASER <sup>b)</sup> RADIATION <sup>c)</sup>            DO NOT STARE INTO THE BEAM OR VIEW DIRECTLY            WITH NON-ATTENUATING OPTICAL INSTRUMENTS         </div> </div>
3R	<div style="display: flex; align-items: center; justify-content: space-around;"> <div style="text-align: center;"> <sup>a)</sup>   </div> <div style="border: 2px solid black; border-radius: 15px; padding: 10px; text-align: center;"> <sup>d)</sup>            CAUTION            HAZARD LEVEL 3R LASER <sup>b)</sup> RADIATION <sup>c)</sup>            AVOID EXPOSURE TO THE BEAM         </div> </div>
3B	<div style="display: flex; align-items: center; justify-content: space-around;"> <div style="text-align: center;"> <sup>a)</sup>   </div> <div style="border: 2px solid black; border-radius: 15px; padding: 10px; text-align: center;"> <sup>d)</sup>            CAUTION            HAZARD LEVEL 3B LASER <sup>b)</sup> RADIATION <sup>c)</sup>            AVOID EXPOSURE TO THE BEAM         </div> </div>
NOTE See 4.6.5 regarding invisible laser beam hazards.	
Conditions applicable to the above table: <sup>a)</sup> Warning label according to Figure 14 of IEC 60825-1. <sup>b)</sup> Where the source of the radiation is a light emitting diode, the word "Laser" above shall be replaced by "LED". <sup>c)</sup> If the radiation is in the range 400 nm to 700 nm it is optional to replace the word "Radiation" with "Light". <sup>d)</sup> Explanatory label (outline) according to Figure 15 of IEC 60825-1. It is permitted for this outline to also encompass the Hazard Symbol according to Figure 14 of IEC 60825-1. <sup>e)</sup> It is recommended but not required to identify those connectors having an optical output by using the warning label according to Figure 14 of IEC 60825-1.	

#### 4.6.2 Marking of connectors of optical transmitters and optical amplifiers

Manufacturers of optical transmitters and manufacturers of optical amplifiers shall comply with the requirements of 4.6.1 as regards each optical port, or group of ports (see 4.6.3) that may be connected to an optical fibre. For such connectors of optical transmitters and optical amplifiers, the requirements of 4.6.1 are modified as below.

If 4.6.1 requires a marking to be provided, then the wavelength range shall be added to the information already required by Tables 1, 2 and 3. Preferred values of wavelength range are:

- 400 nm to 700 nm
- 700 nm to 1 150 nm
- 1 200 nm to 1 400 nm
- 1 400 nm to 1 600 nm.

Between 1 150 nm and 1 200 nm, the exact wavelength shall be marked.

NOTE 1 Between 1 150 nm and 1 200 nm, the value of  $c_7$  (see IEC 60825-1) changes significantly.

NOTE 2 Input ports of (e.g.) Raman Amplifiers may also emit hazardous levels of optical radiation and should be labelled accordingly.

NOTE 3 The above are examples of wavelength ranges: the actual wavelength range of operation may be included in the marking e.g. 1 300 nm to 1 600 nm

#### 4.6.3 Markings for groups of connectors

Groups of connectors such as patch panels may be marked as a group, with just a single clearly visible Hazard Level marking rather than having each connector individually marked. If a group of connectors is enclosed within a housing and it is a foreseeable event that exposure to optical radiation above Hazard Level 1M could result from accessing the connectors in that housing, then a marking shall be clearly visible both before and after the housing is opened. This may require the use of more than one marking.

The tables intentionally omit the (optional) inclusion of the type of optical instrument which might result in an increased hazard for hazard level 1M and 2M (i.e. 'BINOCULARS OR TELESCOPES' or 'MAGNIFIERS') (see Section 5 of IEC 60825-1).

#### 4.6.4 Durability – Indelibility requirements for safety markings

Any marking required by this standard shall be durable and legible. In considering the durability of the marking, the effect of normal use shall be taken into account.

*Compliance is checked by inspection and by rubbing the marking by hand for 15 s with a piece of cloth soaked with water and again for 15 s with a piece of cloth soaked with petroleum spirit. After this test, the marking shall be legible; it shall not be possible to remove marking plates easily and they shall show no curling.*

*The petroleum spirit to be used for the test is aliphatic solvent hexane having a maximum aromatics content of 0,1 % by volume, a kauributanol value of 29, an initial boiling point of approximately 65 °C, a dry point of approximately 69 °C and a mass per unit volume of approximately 0,7 kg/l.*

NOTE The above requirement and test is identical to that contained in 1.7.13 of IEC 60950-1:2001.

#### **4.6.5 Warning for invisible radiation**

If the output of the laser is outside the wavelength range 400 nm to 700 nm, the wording 'laser radiation' in the labels in Tables 1, 2 and 3 shall be modified to read 'invisible laser radiation', or if the output is at wavelengths both inside and outside this wavelength range, to read 'visible and invisible laser radiation'. If a product is classified on the basis of the level of visible laser radiation and also emits in excess of the AEL of Class 1 at invisible wavelengths, the label shall include the words 'visible and invisible laser radiation' in lieu of 'laser radiation'.

#### **4.7 Organizational requirements**

##### **4.7.1 Manufacturers of ready-to-use OFCS, turn key systems or subassemblies**

Manufacturers of OFCS, turnkey end-to-end systems or subassemblies shall:

- 1) ensure that the equipment satisfies the applicable requirements of this standard;
- 2) provide the following information:
  - a) adequate description of the engineering design features incorporated into the product to prevent exposure to radiation above the MPE levels;
  - b) adequate instructions for proper assembly, maintenance and safe use including clear warnings concerning precautions to avoid possible exposure to radiation above the MPE levels;
  - c) adequate instructions to installation organizations and service organizations to ensure the product can be installed and serviced in a manner that the radiation accessible under reasonably foreseeable events meets the requirements of Clause 4;
  - d) the hazard levels at accessible locations within the system or subassembly and the parameters upon which those hazard levels are based;
  - e) for systems with APR:
    - the reaction time and operating parameters of the APR;
    - where installation or service requires overriding an APR, information shall be included to enable the operating organization to specify safe work practices while the APR is overridden and safe procedures reinstating and testing such systems;
    - if a manual initiated restart temporarily inactivates the APR, the timing of the restart shall be stated clearly in the user manual;
    - all scenarios (e.g. removal or failure of a controller or other element) where the APR would not be operable including appropriate precautions that need to be taken under such conditions.
  - f) any other information relevant to the safe use of the OFCS;
  - g) a statement that the equipment must be installed according to the manufacturer's instructions, including the warning "CAUTION: Use of controls or adjustments or performance of procedures other than those specified herein may result in hazardous radiation exposure."

#### **4.7.2 Installation and service organization**

The organization responsible for the installation and servicing of OFCS shall follow the manufacturer's instructions for installation of equipment in a manner that will ensure that the accessible radiation under reasonably foreseeable events satisfies the requirements of Clause 4.

Before placing an OFCS into service, the installation organization or service organization, as applicable, shall ensure that APR, if used, is in appropriate working condition as designated in 4.5 and 4.8.

For systems with accessible locations other than hazard level 1 or 2, the installation organization and/or the service organization shall:

- a) provide adequate laser safety training of personnel responsible for carrying out installation and service activities;
- b) ensure that suitable access controls and warning labels are employed on controlled and restricted locations.

#### **4.7.3 Operating organization**

The operating organization has the ultimate responsibility for the safety of the end-to-end system. This includes, especially:

- a) identification of the location type at all accessible locations of the entire OFCS;
- b) ensuring that the hazard levels are not exceeded for those location types under reasonably foreseeable events;
- c) ensuring that installation and service is performed only by organizations with the capability of satisfying the requirements of 4.2 to 4.9;
- d) ensuring that access to restricted and controlled locations is appropriately addressed with respect to laser safety;
- e) ensuring continuous compliance with system manufacturing, operating, installation, service and safety requirements.

### **4.8 Assessment of hazard level**

#### **4.8.1 Determination of hazard level**

The hazard level is determined by the measurement of the optical radiation that could become accessible following any reasonably foreseeable event (e.g. fibre break) during operation and maintenance. The methods for the determination of compliance with the specified radiation limit values are the same as those described for classification in IEC 60825-1. Measurements need to be taken under the appropriate conditions, e.g. simulated fibre cable break, and shall be based on the relevant clauses in IEC 60825-1.

The assessment of the hazard level with and without automatic power reduction shall take place:

- 1 s after the reasonably foreseeable event for unrestricted locations, unless measurement at a later time would result in a larger exposure;
- 3 s after the reasonably foreseeable event for restricted and controlled locations, unless measurement at a later time would result in a larger exposure.

In circumstances where it is difficult to carry out direct measurements, an assessment of hazard level based on calculations is acceptable. For example, the knowledge of the laser or amplifier power and fibre attenuation may allow an assessment of the hazard at any particular location.

For OFCS with automatic power reduction, the hazard level will be determined by the accessible emission (pulse or continuous wave) after the time interval given above (1 s for unrestricted locations, 3 s for restricted locations or controlled locations). Additionally, the MPE requirement in 4.8.2 shall be satisfied.

#### **4.8.2 Impact of using automatic power reduction features**

Where the OFCS uses an automatic power reduction feature to meet the limits of a hazard level that is lower than that which would have to be assigned if no automatic power reduction feature would be present, the irradiance or radiant exposure during the maximum time to reach the lower hazard level specified in 4.8.1 (1 s for unrestricted, 3 s for restricted or controlled locations) shall not exceed the irradiance or radiant exposure limits (MPE). For controlled locations the measurement distance is 250 mm for this subclause only.

#### **4.8.3 Conditions for tests and assessment**

Tests and assessments shall be carried out under reasonably foreseeable fault conditions.

In some complex systems (e.g. where the optical output is dependent on the integrity of other components and the performance of circuit design and software), it may be necessary to use other recognised methods for hazard/safety assessment (see Annex C).

However, faults which result in the emission of radiation in excess of the hazard level need not be considered if:

- they are for a limited duration only; and
- it is not reasonably foreseeable that human access to the radiation will occur before the product is taken out of service.

NOTE When applying the relevant MPE requirement in 4.8 in relation to a beam exiting, e.g. a broken fibre-end or un-made connector, two factors are important:

- a) is it reasonably foreseeable that a person's eye will be exposed to the beam?
- b) is it reasonably foreseeable that a person's skin could be irradiated by the beam?

When determining what is reasonably foreseeable, consideration is given to the physical location of the beam exit point, the distance between the exit point and the eye or skin, and the time taken for the APR to reduce the exposure to the level required by 4.9. Even if naked eye or skin exposure is not reasonably foreseeable, the possibility of fire hazard should also be considered.

#### **4.9 Hazard level requirements by location type**

The required hazard level shall be determined for each accessible location within an OFCS.

NOTE 1 This includes access to optical fibres that can become broken.

NOTE 2 This standard is applicable for the operation and maintenance of OFCS. For the safety of the user, hazard level 4 is not allowed throughout the standard. Where systems employ normal transmitting power levels exceeding the acceptable hazard level for the particular location type, protection systems such as automatic power reduction may be used to determine the actual hazard level.

#### **4.9.1 Unrestricted access locations**

At a location with unrestricted access the hazard level shall be 1, 1M, 2 or 2M.

NOTE If the applicable limit of hazard level 1M is larger than the limit of 2 and less than the limit of 3B, hazard level 1M is allocated.

#### **4.9.2 Restricted access locations**

At a location with restricted access the hazard level shall be 1, 1M, 2, 2M or 3R.

NOTE 1 If the applicable limit of hazard level 1M or 2M is larger than the limit of 3R and less than the limit of 3B, hazard level 1M or 2M is allocated respectively.

NOTE 2 If the applicable limit of hazard level 1M is larger than the limit of 2 and less than the limit of 3B, hazard level 1M is allocated.

#### **4.9.3 Controlled access locations**

At a location with controlled access the hazard level shall be 1, 1M, 2, 2M, 3R or 3B.

## **Annex A** (informative)

### **Rationale**

The safety of laser products, equipment classification, requirements and user's guide are covered by IEC 60825-1. Part 1 is primarily aimed at self-contained products which are under effective local control. An OFCS will be safe under normal operating conditions because the optical radiation is totally enclosed under intended operation. However, because of the extended nature of these systems (where optical power, under certain conditions, may be accessible many kilometres from the optical source), the precautions to minimise the hazard will be different from those concerning laser sources which are normally under local operator control. (It should be noted that many OFCS contain LEDs, which are included in the scope of IEC 60825-1.)

The potential hazard of an OFCS depends on the likelihood of the protective housing being breached (e.g. a disconnected fibre connector or a broken cable) and on the nature of the optical radiation that might subsequently become accessible. The engineering requirements and user precautions that are required to minimise the hazard are specified in this Part 2 of IEC 60825.

Each accessible location within an OFCS is allocated, by the system operating organization or its delegate, a hazard level that gives a guide as to the potential hazard if optical radiation becomes accessible. These hazard levels are described as hazard levels 1 to 4, in a fashion similar to the classification procedure described in IEC 60825-1. In fibre optic applications the limits of hazard levels 1M and 2M are often higher than the limit of hazard level 3R, but less than the limit of hazard level 3B. For these applications hazard level 3R is not applicable (see notes to 3.6, 3.8 and 3.9).

Where operating organizations subcontract the installation, operation or maintenance of fibre optic communication systems, the responsibilities in relation to laser safety should be clearly defined by the operator.

In summary, the primary differences between IEC 60825-1 and this Part 2 are as follows.

- A whole OFCS will not be classified as required by IEC 60825-1. This is because under intended operation, the optical radiation is totally enclosed, and it can be argued that a rigorous interpretation of IEC 60825-1 would give a Class 1 allocation to all systems, which may not reflect the potential hazard accurately. However, if the source can be operated separately, it should be classified according to IEC 60825-1.
- Each accessible location in the extended enclosed optical transmission system will be designated by a hazard level on similar procedures as those for classification in IEC 60825-1, but this level will be based not on accessible radiation but on radiation that could become accessible under reasonably foreseeable circumstances (e.g. a fibre cable break, a disconnected fibre connector etc.).
- The nature of the safety precautions required for any particular hazard level will depend on the type of location, i.e. domestic premises, industrial areas where there would be limited access, and switching centres where there could be controlled access. For example, it is specified that in the home a disconnected fibre connector should only be able to emit radiation corresponding to Class 1 or 2, whilst in controlled areas it could be higher.



## Annex B (informative)

### Summary of requirements at locations in OFCS

Hazard Level	Location type		
	Unrestricted	Restricted	Controlled
1	No requirements	No requirements	No requirements
1M	Hazard level 1 from connectors that can be opened by an end-user <sup>a</sup> No labelling or marking requirement <sup>b</sup>	No labelling or marking required if connectors that can be opened by end-user are hazard level 1. If output is hazard level 1M then labelling or marking is required <sup>b</sup>	No requirements
2	Labelling or marking <sup>b</sup>	Labelling or marking <sup>b</sup>	Labelling or marking <sup>b</sup>
2M	Labelling or marking <sup>b</sup> , and Hazard level 2 from connector <sup>b</sup>	Labelling or marking <sup>b</sup>	Labelling or marking <sup>b</sup>
3R	Not permitted <sup>c, d</sup>	Labelling or marking <sup>b</sup> , and Hazard level 1M or 2M from connector <sup>a</sup>	Labelling or marking <sup>b</sup> , and Hazard level 1M or 2M from connector <sup>a</sup>
3B	Not permitted <sup>c, d</sup>	Not permitted <sup>c, d</sup>	Labelling or marking <sup>b</sup> , and Hazard level 1M or 2M from connector <sup>a</sup>
4	Not permitted <sup>c, d</sup>	Not permitted <sup>c, d</sup>	Not permitted <sup>c, d</sup>
NOTE Where the information contained in this annex differs from the requirements contained in Clause 4, the requirements of Clause 4 have precedence.			
<p>a See 4.4.</p> <p>b See 4.6.</p> <p>c See 4.5 and 4.8.2. Where systems employ normal transmitting power levels exceeding the acceptable hazard level for the particular location type, protection systems such as automatic power reduction may be used to determine the actual Hazard Level.</p> <p>d See 4.9.</p>			

## **Annex C** (informative)

### **Methods of hazard/safety analysis**

Some methods of hazard/safety analysis include the following:

- a) preliminary hazard analysis (PHA) including circuit analysis. This method may be used in its own right, but is an essential first stage in the application of other methods of hazard/safety assessment;
- b) consequence analysis – see the IEC 61508 series of standards [5];
- c) failure modes and effects analysis (FMEA);
- d) failure modes, effects and criticality analysis (FMECA) (see IEC 60812 [1]);
- e) fault tree analysis (FTA);
- f) event tree analysis;
- g) hazards and operability studies (HAZOPS).

Appropriate testing should be implemented to supplement the analysis whenever necessary. The method of analysis and any assumptions made in the performance of the analysis should be stated by the manufacturer/operator.

## **Annex D** (informative)

### **Application notes for the safe use of OFCS**

#### **D.1 Introduction**

This annex provides guidance on the application of this standard to specific practical situations. It is an informative annex to assist the users of this standard in applying the requirements of IEC 60825-1 and IEC 60825-2 to their specific application. It does not contain any requirements.

This standard applies to OFCS. In such systems the optical power can be transmitted for long distances beyond the optical source and measures need to be taken to ensure that the potential hazards from a broken communications path are minimised. In order to know the extent of the potential hazard existing in an OFCS it is necessary to assign a hazard level to those locations that can become accessible: this is similar to, but replaces, the designation of a Class to the equipment within IEC 60825-1.

It is possible to configure an optical fibre communications system to act as a closed-loop control system, such that when the communications path is broken the transmitted signal is automatically reduced in power within a short period of time to a safe value. It is therefore possible to have two systems, one with automatic power reduction (APR) and another without APR, both having the same hazard level (and therefore the same degree of safety): the signal level under normal operating conditions in the system with APR can then be much higher than the signal level in the system without APR. Because the APR feature is critical to safety, the reliability of this feature should be adequate and recommendations are provided in this Annex.

Whereas the Part 1 standard applies to discrete laser products, this Part 2 applies to complete end-to-end systems. Because the subassemblies that generate or amplify optical radiation are critical to the safety of the OFCS, and because they have to meet part of the requirements, these items are also included within the scope of this standard. The manufacturers of individual passive components or passive subassemblies that are not yet incorporated into the end-to-end system can not know the associated hazard level and so these items are excluded from the scope of this standard.

This standard does not address safety issues associated with explosion or fire with respect to OFCS deployed in hazardous locations.

#### **D.2 Areas of application**

##### **D.2.1 Typical OFCS installations**

a) Locations with controlled access (see 3.13):

- cable ducts;
- street cabinets;
- dedicated and delimited areas of distribution centres;
- test rooms in cable ships.

NOTE Where service access to cable ducts and street cabinets could expose the general public to radiation in excess of the accessible emission limit of Class 1, appropriate temporary exclusion provisions (e.g. a hut) should be provided.

- b) Locations with restricted access (see 3.14):
  - secured areas within industrial premises not open to the public;
  - secured areas within business/commercial premises not open to the public (for example telephone PABX rooms, computer system rooms, etc.);
  - general areas within switching centres;
  - delimited areas not open to the public on trains, ships or other vehicles.
- c) Locations with unrestricted access (see 3.15):
  - domestic premises;
  - services industries that are open to the general public (e.g. shops and hotels);
  - public areas on trains, ships or other vehicles;
  - open public areas such as parks, streets, etc.;
  - non-secured areas within business/industrial/commercial premises where members of the public are permitted to have access, such as some office environments.

OFCS may pass through unrestricted public areas (for example in the home), restricted areas within industrial premises, as well as controlled areas such as cable ducts or street cabinets.

Optical local area networks (LANs) may be deployed entirely within restricted business premises.

Fibre systems may be entirely in unrestricted domestic premises such as hi-fi inter-connections.

For requirements on infra-red (IR) wireless LANs or free space optical systems, see separate applicable part of IEC 60825-12 [16].

## **D.2.2 Typical system components**

- a) Fibre cables:       single fibre/multiple fibre/ribbon construction  
                          single mode/multimode  
                          all dielectric or hybrid construction  
                          carrying single/multiple wavelengths  
                          uni/bidirectional fibre  
                          communications/power feeding
- b) Optical sources:  LEDs, VCSEL, Fabry Perot or DFB lasers, pump lasers, optical  
                          amplifiers  
                          bulk/distributed, continuous/low/high-frequency emission
- c) Connectors:       simplex/duplex/multiway/hybrid
- d) Power splitters, wavelength multiplexers, attenuator
- e) Protective enclosures and housings
- f) Fibre distribution frames

### D.2.3 Typical operating functions

- a) Installation
- b) Operation
- c) Maintenance
- d) Servicing
- e) Fault-finding
- f) Measurement (including optical time domain reflectometry (OTDR))

### D.3 OFCS power limits

The maximum mean power for each hazard level for the most important wavelengths and optical fibre types used in OFCS is presented in Table D.1. For most typical systems with duty cycles between 10 % and 100 %, the peak power can be allowed to increase as the duty cycle decreases. However, for duty cycles  $\leq 50$  %, it is most straightforward to limit the peak powers to twice these mean power limits, although IEC 60825-1 can be used for a more sophisticated analysis in order to identify any increase in peak powers permissible for these types of systems. This is especially valid when "visible sources" with wavelengths in the photochemical hazard area are used.

NOTE For the most common single mode and multimode fibres the point source limits have to be applied. Fibres with core diameters above 150  $\mu\text{m}$  (e.g. plastic optical fibre (POF) and hard clad silica fibre (HCS)) have to be considered as intermediate extended sources. However, the applicable apparent source size for the determination of the factor  $C_6$  may depend on the actual degree of mode-filling.

**Table D.1 – OFCS power limits for 11  $\mu\text{m}$  single mode (SM) fibres and 0,18 numerical aperture multimode (MM) fibres (core diameter < 150  $\mu\text{m}$ )**

Wavelength and fibre type	Hazard level					
	1	1M	2	2M	3R	3B
633 nm (MM)	0,39 mW (-4,1 dBm)	3,9 mW (+5,9 dBm)	1 mW (0 dBm)	10 mW (+10 dBm)	See note to 3.9.	500 mW (+27 dBm)
780 nm (MM)	0,57 mW (-2,5 dBm)	5,6 mW (+7,5 dBm)	-	-	See note to 3.9.	500 mW (+27 dBm)
850 nm (MM)	0,78 mW (-1,1 dBm)	7,8 mW (+8,9 dBm)	-	-	See note to 3.9.	500 mW (+27 dBm)
980 nm (MM)	1,42 mW (+1,53 dBm)	14,1 mW (+11,5 dBm)	-	-	See note to 3.9.	500 mW (+27 dBm)
980 nm (SM)	1,42 mW (+1,53 dBm)	2,66 mW (+4,2 dBm)	-	-	7,26 mW (+8,6 dBm)	500 mW (+27 dBm)
1 310 nm (MM)	15,6 mW (+12 dBm)	156 mW (+21,9 dBm)	-	-	See note to 3.9.	500 mW (+27 dBm)
1 310 nm (SM)	15,6 mW (+12 dBm)	42,8 mW (+16,3 dBm)	-	-	80 mW (+19 dBm)	500 mW (+27 dBm)
1 400 nm ... 1 600 nm (MM)	10 mW (+10 dBm)	384 mW (+25,8 dBm)	-	-	See note to 3.9.	500 mW (+27 dBm)
1 420 nm (SM)	10 mW (+10 dBm)	115 mW (+20,6 dBm)	-	-	See note to 3.9.	500 mW (+27 dBm)
1 550 nm (SM)	10 mW (+10 dBm)	136 mW (+21,3 dBm)	-	-	See note to 3.9.	500 mW (+27 dBm)

**NOTE 1 Hazard Levels 1M and 2M**

The maximum power shown in the table for 11 microns fibre is limited by the power density. The precise fibre power limit is therefore determined by the minimum expected beam divergence, which is in turn dependent on the single mode fibre mode field diameter (MFD). This may change for different values of the MFD and there are significant changes in Class limits as the MFD changes. Some high power connectors use enlarged mode field diameter (MFD) and the far field divergence is lower. These connectors can result in a higher hazard level and determination of the hazard level when using these connectors is strongly recommended.

**NOTE 2 1 310 nm figures**

The 1 310 nm figures are calculated for 1 270 nm, which is the shortest wavelength in the "1 310 nm" telecommunications window.

**NOTE 3 Fibre parameters**

The fibre parameters used are the most conservative cases; single mode figures are calculated for a fibre of 11 microns mode field diameter, and multimode figures for a fibre with a numerical aperture of 0,18. Many systems operating at 980 nm and 1 550 nm use fibres with smaller MFDs. For example, the limit for hazard level 1M when a wavelength of 1 550 nm is transmitted along dispersion shifted fibre cables having upper limit values of MFD of 9,1  $\mu\text{m}$  is 197 mW. For other MFD values and wavelengths, please refer to IEC 60825-1, example A.6.3.

**NOTE 4 Hazard level 1M limits for <1 310 nm**

The hazard level 1M limits for single mode fibres at 900 nm and below are not presented here, as the divergence that these wavelengths will undergo is rather variable. This is because these wavelengths are in fact multimoded in standard 1 310 nm single mode fibre, and the exact divergence will depend on the rather unpredictable degree of mode mixing. This mode mixing variability is also a potential problem when trying to evaluate these wavelengths on true multimode fibre. If it is necessary to calculate a value for these cases, the assumption that the fibre carries all of its power in the fundamental mode and use of the single mode equations will yield a conservative value.

**NOTE 5 Multimode fibres with core diameters above 150  $\mu\text{m}$** 

These fibres have to be considered as intermediate extended sources (e.g. hard clad silica (HCS) fibres with 200  $\mu\text{m}$  or plastic optical fibres with 1000  $\mu\text{m}$  core diameter). The applicable source size may depend on the degree of mode filling and should be determined in detail before calculating the limit values.

**NOTE 6 Hazard level 2 limits**

It can be shown, that for apparent source sizes smaller than 33 mrad (most cases in fibre communication techniques) the hazard level 2 limits are always lower than the appropriate hazard level 1M limits: Safe for the unaided eye, but potentially unsafe when using optical instruments.

**NOTE 7 Multiple fibres and ribbon cables**

The limits in the table are calculated for single fibres only. If multiple fibres or ribbon fibres with single fibres located in close proximity to each other have to be assessed, each individual fibre and each possible grouping of the fibres has to be evaluated.

**NOTE 8 1 420 nm figure**

The 1 420 nm figure is calculated for the 1420 nm to 1 500 nm Raman range.

**D.4 Hazard level evaluation examples****D.4.1 Multiple wavelengths over the same fibre**

When more than one wavelength is transmitted along a single fibre, such as on a wavelength division multiplex (WDM) system, then the hazard level depends on both the power levels and on whether the wavelengths are additive. For skin exposure to wavelengths usually used in OFCS, the hazards are always additive. For most fibre systems, 1 400 nm is the point at which addition conditions change:

- a) if two wavelengths are both below 1 400 nm, they add, i.e. the combined hazard is higher;
- b) if two wavelengths are both above 1 400 nm, they add, i.e. the combined hazard is higher;
- c) if one wavelength is above 1 400 nm and one is below, then hazards do not add, i.e. the combined hazard does not increase.

It is necessary to calculate separately for skin and retinal hazards.

To calculate the hazard level for a multi-wavelength system it is necessary to calculate the system power at each wavelength as a proportion of the AEL for that Class at that wavelength (for example 25 %, 60 %, etc., up to 100 %), and then add these components together. If the totalled proportion exceeds 1 (100 %), then the hazard level exceeds the accessible emission limits for that Class. This procedure should also be used when determining the APR timing by using the MPE table instead of the AEL tables.

#### D.4.1.1 Multi-wavelength example

An optical transmission system using multimode fibre of 50 µm core diameter and a numerical aperture  $0,2 \pm 0,02$  carries six optical signals: at wavelengths of 840 nm, 870 nm, 1 290 nm, 1 300 nm, 1 310 nm and 1 320 nm. Each of these signals has a maximum time-averaged power of  $-8$  dBm (0,16 mW). Determine the hazard level at the transmitter site.

In the absence of any other information concerning the transmitter emission duration when a connector is removed, assume that no shut-down system operates, and then determine the hazard level based on the power levels accessible at the transmitter connector (removing the connector is a reasonably foreseeable event).

Assess on the basis of  $t = 100$  s emission duration for unintended viewing (see 8.4 e) of IEC 60825-1).

Table 5 of IEC 60825-1 indicates that the effects of all wavelengths are additive. The evaluation must therefore be made on the basis of the ratio of the accessible emission at each wavelength to the AEL for the applicable class at that wavelength (see 8.4 b) of IEC 60825-1).

Note, however, that the AELs are constant in the wavelength range 1 200 nm to 1 400 nm; hence, the four signals in the vicinity of 1 300 nm may be considered as a single signal with a power level equal to the sum of powers in those signals.

First compare the emission levels with the AEL for Class 1:

Since we have a small source with 50 µm core diameter the angular subtense  $\alpha$  of the source is  $0,5$  mrad  $< \alpha_{\min}$ .  $T_2 = 10$  s (see IEC 60825-1, notes to Tables 1 to 4) and  $T_2 < t$  (100 s, see above).

$$P_{\text{AEL}} = 3,9 \times 10^{-4} C_4 C_7 \text{ W}$$

where

$$C_4 = 10^{0,002(\lambda - 700)} \text{ for } 840 \text{ nm and } 870 \text{ nm}$$

$$C_4 = 5 \text{ for wavelengths } > 1 \text{ 050 nm}$$

and

$C_7 = 1$  for 840 nm and 870 nm

$C_7 = 8$  for wavelengths > 1 050 nm

hence  $AEL_{840 \text{ nm}} = 0,74 \text{ mW}$

$AEL_{870 \text{ nm}} = 0,85 \text{ mW}$

$AEL_{1\,300 \text{ nm}} = 15,6 \text{ mW}$

The measurement specifications given in 9.3 of IEC 60825-1 require the most restrictive condition in Table 10 of IEC 60825-1 to be applied. For a divergent beam from an optical fibre the most restrictive condition is 2. Using Table 10, the aperture diameter is 7 mm and the measuring distance is 14 mm for thermal limits.

Using the expression for the diameter of the beam from an optical fibre (equation (1) in A.6 of IEC 60825-1), the diameter at the 63 % (1/e) points for the smallest NA fibre (worst case) is:

$$d_{63} = \frac{2r \text{ NA}}{1,7} = \frac{2 \times 14 \text{ mm} \times 0,18}{1,7} = 3,0 \text{ mm}$$

Thus, in this case, all of the fibre power would be collected by the 7 mm aperture, and no correction is needed.

Summing the ratios of the power at each wavelength to the corresponding AEL yields:

$$\sum \left[ \frac{(\text{Power})}{\text{AEL}} \right] = \frac{0,16}{0,74} + \frac{0,16}{0,85} + \frac{4 \times 0,16}{15,6} = 0,45$$

This ratio is less than 1; thus, the accessible emission is within Class 1 limits and so hazard level 1 applies at that location.

#### **D.4.2 Bi-directional (full duplex) transmission**

There is no additive effect from each separate direction of transmission, as each broken fibre cable end represents a separate hazard if the fibre breaks. The hazard level is determined by the transmission direction with the higher power.

#### **D.4.3 Automatic power reduction**

By using automatic power reduction in an end-to-end OFCS it is possible to assign a lower hazard level than would otherwise have been the case. This is important when the hazard level of the internal optical transmitters/amplifiers of a system may put a limitation on where that system may be deployed. See Annex B.

Automatic power reduction should not take the place of good working practices and proper servicing and maintenance. Also, the reliability of the APR mechanism should be taken into account when assessing the hazard level.



Assessment of the hazard level should take place at the time of reasonably foreseeable human access to radiation (for example after a fibre break), unless measurement at a later time would result in a larger exposure (see 4.8.1 and 4.8.2).

Automatic power reduction cannot be regarded as a universally protective measure because, after a fibre break, it is common practice to use an optical test set (usually an optical time domain reflectometer, OTDR) to determine the location of the break. This instrument launches laser power down the fibre under test. Therefore, even if the normal telecommunications transmitter is shut down or removed, the diagnostic instrument could, at a later time, apply laser power to the fibre.

These OTDRs typically operate at Class 1, so no potential hazard is present at such sources. However, higher power systems have a longer range and may require Class 1M, Class 3R or Class 3B OTDRs to detect the break. Also, OTDR signals may be amplified to a higher Class if sent through an optically amplified system.

Except for turnkey systems designed for use in unrestricted locations it is important that a laser safety professional or the OFCS operator decide for each location (or for the entire span of a network) the hazard level that should be permitted, consistent with the level of laser training provided to their staff and others who could access their network. Hazard level 1M or hazard level 3R are often chosen because workers would be instructed not to use any optical (collimating) instruments that would increase the hazard and typically they would have no need to examine the fibre at a close range. Hazard level 3B is acceptable in controlled locations with proper labelling and connector conditions.

This subclause will examine APR under several circumstances:

- in systems with optical amplifiers;
- on a readily accessible fibre in a splice tray;
- at a fibre optic connector;
- on a fibre not readily accessible in a submerged/buried cable;
- in restricted and unrestricted locations;
- in the case of ribbon cables.

For upper limit values of typical wavelengths see Clause D.3 and Table D.1.

#### **D.4.3.1 Optical amplifiers**

Optical amplifiers have the capability to generate significant levels of optical power. Powers of the order of  $\geq 500$  mW are not uncommon. This may result in a potential hazard without the use of protection mechanisms. For this reason it is important that a suitable means is employed for limiting such power levels when amplifiers are accessed for repair or maintenance. Consideration of appropriate mechanisms including, but not limited to, APR to reduce the hazard level and the use of shuttered connectors may be necessary.

#### **D.4.3.2 APR for distributed optical amplification systems**

APR for distributed optical amplification systems (e.g., Raman) is required not only on main signal sources but also on pump lasers. The response of such a distributed optical amplification system could have shorter time-periods than other (lower power) systems, depending on the actual pump power in the Raman amplification system of interest.

#### **D.4.3.3 Fibre in a splice tray**

As powers increase in an OFCS, it is important that splicing operations on potentially energized fibres of hazard level 3B take into consideration the safety of the operator, and a fully enclosed splicing system should be employed in such cases. If splicing is not to take place in a protective enclosure, automatic power reduction is an option for reducing the hazard level and, therefore, the exposure.

#### **D.4.3.4 Connectorised systems**

Another occurrence where access to energized fibre is reasonably foreseeable is when an energized system has one or several of its fibres disconnected at an optical connector.

A number of solutions exist to achieve a safer hazard level when disconnecting optical connectors. For example, one mechanical solution that can be considered is the use of shuttered connectors. Such a solution, provided the connectors meet the reliability characteristics outlined in Clause D.5, provides control of the exposure from unmated connectors. These shutters should operate within 1 s in unrestricted locations and 3 s in restricted and controlled locations. (It should be noted that shutters might not be practical or desirable for controlling optical power levels exceeding hazard levels 1M, 2M or 3R. In these situations, APR may be the only solution.)

#### **D.4.3.5 Submerged/buried cable for undersea systems**

Certain undersea systems have the potential to carry substantial optical power levels. Typically, damage to fibre cable is incurred on the submerged portion, not on the buried land portion. Because the fibre cable is submerged, an appropriate shipping vessel is necessary to retrieve the cable and repair it, which may take hours or days to accomplish. As automatic power reduction may not be appropriate or practical for these systems, rigorous administrative controls, including manual laser shutdown procedures, may need to be employed. This will ensure that proper working conditions are maintained below hazard level 4, as specified in this standard.

Manual shutdown of the system under repair/maintenance/service conditions is currently the practice for many operators because of the hazardous electrical power associated with the submerged cable. This electrical power is used to power the undersea repeaters along the route. In the future, for repeaterless systems, this electrical power may no longer be a part of the cable. However, the work practice to de-energize fibre before extraction should be continued and maintained because of the hazards of the associated optical power.

#### D.4.3.6 APR for restricted and unrestricted locations

OFCS designers need to be aware of the restrictions in 4.9 regarding restricted and unrestricted locations. For these locations the designers should consider the incorporation of APR into any system that has the potential to expose humans to optical power of Class 3B or above. Appropriate break detection and reliability precautions should be taken when designing this power down system.

#### D.4.3.7 APR for ribbon cables

The use of ribbon cables can place the OFCS in a more restrictive hazard level. A careful hazard assessment, as explained in D.4.5, should take place, and appropriate APR, shuttering and splicing considerations should be evaluated and implemented with respect to the potentially increased hazard level and the location of the OFCS.

#### D.4.4 Multiple fibres

The hazard from bundles of broken (i.e. not cleaved) fibre within a broken fibre cable does not increase beyond that of the worst case fibre within that cable. This has been shown by a considerable number of measurements on broken fibre ends, consideration of reflection and scattering at fibre ends, and random alignment and movement of fibre ends.

These measurements and considerations have also been shown to apply to broken ribbon fibre, but not to ribbon fibre cleaved as a unit (see D.4.5).

#### D.4.5 Ribbon cable

Ribbon fibre ends cleaved as a unit may exhibit a higher hazard level than that of a single fibre. An example would be eight fibres within a ribbon, each carrying a power level just within hazard level 1M. Individually, they are of a relatively safe 1M hazard level, but cleaved as an unseparated unit, the hazard level might become 3B, thus presenting a genuine eye risk. This results from the small centre-centre separation distances of typical ribbon fibre of 150  $\mu\text{m}$  to 250  $\mu\text{m}$ . The low angular separation of several equally spaced fibres leads to a cumulative effect. At the measurement distance of 100 mm, the  $\alpha$  of one single mode fibre is  $< \alpha_{\text{min}}$  for cw emission ( $\alpha_{\text{min}} = 1,5 \text{ mrad}$ , (see 8.4 c) of IEC 60825-1).

The angular subtense of the ribbon in its plane will depend on the number of fibres and their separation (for example an eight-fibre ribbon with fibres spaced at 200  $\mu\text{m}$  will subtend 14 mrad at 100 mm). This subtense exceeds  $\alpha_{\text{min}}$  and the ribbon is considered as an intermediate extended source and the point source AEL may be increased by factor  $C_6$ . Any angular dimension that is more than  $\alpha_{\text{max}}$  ( $\alpha_{\text{max}} = 100 \text{ mrad}$ ) or less than  $\alpha_{\text{min}}$  (1,5 mrad) should be limited to  $\alpha_{\text{max}}$  or  $\alpha_{\text{min}}$  respectively before determining the mean.

The total power permitted in the ribbon fibre is determined by the worst case combination of any individual fibres (for details see IEC 60825-1 classification rules for non-circular and multiple sources).

#### D.4.5.1 Ribbon fibre example calculation

The ribbon consists of eight equally spaced (by 200  $\mu\text{m}$ ) single mode fibres. What is the maximum allowed Class 1 cw output power per fibre for a wavelength of a) 1 310 nm and b) 1 550 nm?

Solution for a)

Evaluations should be made for every single fibre or assembly of fibres, necessary to assure that the source does not exceed the AEL for each possible angle  $\alpha$  subtended by each partial area, where  $\alpha_{\min} < \alpha \leq \alpha_{\max}$ . Table D.2 below shows the AEL per combination of fibres as well as the resulting maximum permitted power within one single fibre of the combination. The combination of two fibres represents the worst case. Therefore, the maximum power for one single fibre of the ribbon is 9,3 mW.

**Table D.2 – Relation between the number of fibres in a ribbon fibre and the maximum permitted power (example)**

Combination (No. of fibres)	1	2	3	4	5	6	7	8
$C_6$	1	1,2	1,9	2,5	3,2	3,9	4,5	5,2
$T_2$	10	10,07	10,31	10,55	10,8	11,06	11,32	11,59
AEL/mW	15,6	18,7	28,9	39	49	58,8	68,6	78,2
Resulting limit per fibre/mW	15,6	9,3	9,6	9,75	9,8	9,8	9,8	9,8

Solution for b)

At 1 550 nm, the hazard for the cornea dominates. Consequently, there is no correction factor  $C_6$ . The maximum power per fibre is simply the corresponding AEL for one source, divided by the number of fibres, i.e.  $10 \text{ mW}/8 = 1,25 \text{ mW}$ .

#### D.4.5.2 Ribbon fibre issues

The additive property of the radiation hazard from ribbon fibre sources, therefore, means that the hazard level of a location can depend on the choice of cable type. For instance it is impractical to switch off essential systems if they are designed for live maintenance and if the resulting hazard level at the location is not compatible with the location type. A solution will be required to reduce the hazard if ribbon fibres are to be used in this fibre network.

The solution may not be too difficult. As broken ribbon fibres do not present a problem, it is only the cleaving and splicing operations that require consideration. Separated ribbon, being no different from normal fibre, also does not present a problem.

If access to unseparated cleaved fibre end can be assuredly prevented, then, as the hazard level relates to accessible emission limits, the hazard level may be prevented from increasing. Any method would have to prevent access under reasonably foreseeable circumstances (i.e. not just an instruction "not to look!"). A possibility might be to use a cleaving tool that stayed attached to the cleaved fibre end until it was inserted into a ribbon splicer that likewise prevented access during the whole operation.

Once ribbon fibre is used in the network, it will be difficult to control what type of system is put onto it.

#### D.4.6 Power diminution due to power splitters and fibre losses

This power diminution may be taken into account, for example at the customer side of a distribution network, the hazard level after some length of fibre may be lower than at the distribution point.

Figure D.1 shows the layout of a typical passive optical network (PON).

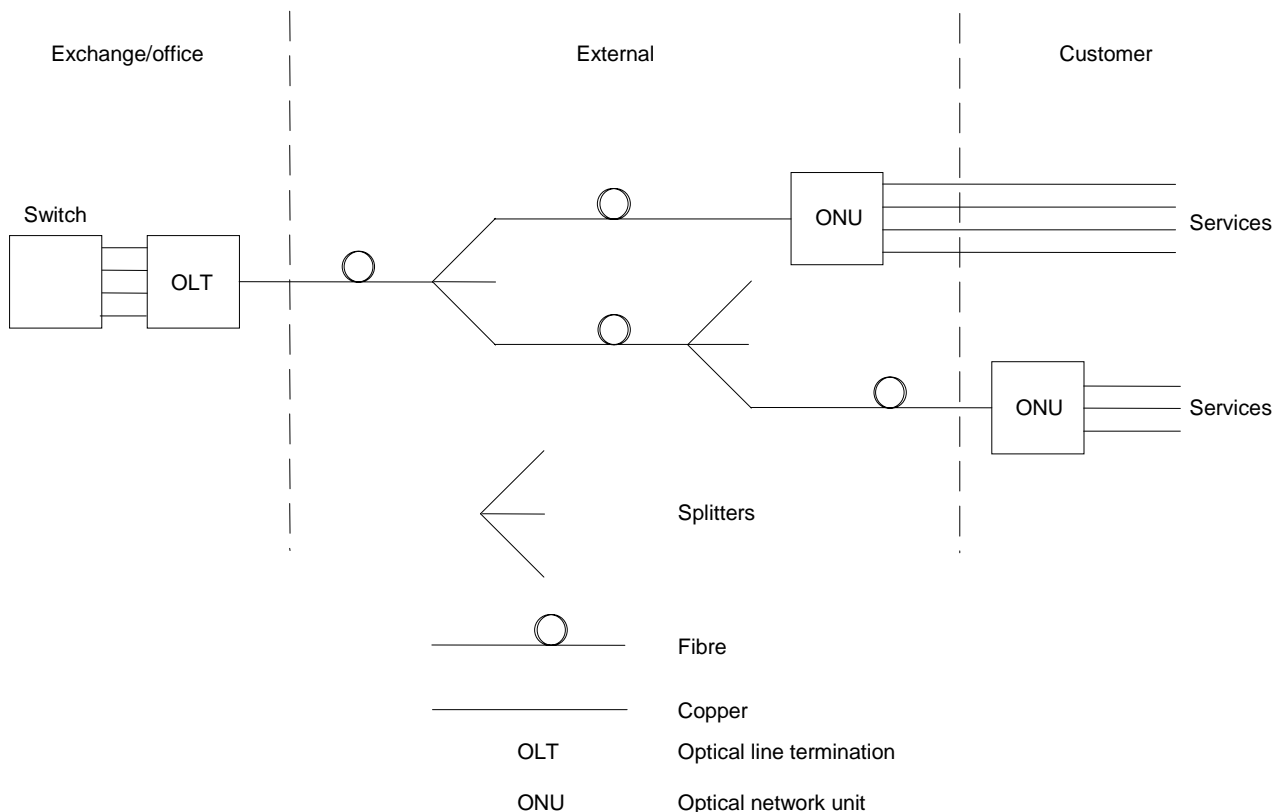

IEC 1054/05

**Figure D.1 – PON (passive optical network)-based system**

#### D.4.7 General considerations and examples

- a) The assessment of hazard levels should always consider reasonably foreseeable fault conditions (see 4.8.3) resulting from random failures in hardware components and systematic failures (e.g. failure of software controlling the APR function). Consequently, it may be necessary to include multiple fault conditions: a determination of the probability of such conditions occurring is to be conducted by the responsible organization.

NOTE Whereas IEC 60825-1 refers to single fault conditions, it may be reasonably foreseeable that more than one fault will combine to cause a dangerous situation.

- b) Service conditions often result in higher hazard levels (see Clause 5). These should be considered by the responsible organization and persons. Examples are: introduction of high power or amplified optical time domain reflectometer pulses into an operating fibre network; failure or overriding of the APR (see 4.7.1e).
- c) Changing of components, system parameters or the network structure may result in changed hazard levels. Examples are: replacement of conventional bundled fibre cables by ribbon cables (this may be beyond the direct supervision of the network manager); change of the modulation scheme; change in transmitter circuit pack power or wavelength; addition/change of optical amplifiers, etc.

## **D.5 Fault analysis – Explanation and guidance**

Fault analysis is necessary for systems where the optical output is dependent on the integrity of other components and the performance of the circuit design. It is recommended that the manufacturer or operator should carry out a fault analysis.

### **D.5.1 Definitions**

For the purpose of this Clause D.5, the following definition applies.

#### **FITs**

an indicator of reliability defined as the number of failures per  $10^9$  h

### **D.5.2 Fault analysis**

Hazard levels are assessed under reasonably foreseeable fault conditions. The purpose of fault analysis is to identify failures in the optical control circuits that could have significant consequences affecting the assigned hazard level. For example, it is permitted for the *lasers* used in locations with hazard level 1M to emit optical power exceeding the upper limit of hazard level 1M under normal operating conditions, if an adequate APR feature is provided. However, in case of a fibre break, the accessible radiation is reduced so that it is within the limits of hazard level 1M. If however a fault in a component in the laser drive circuit or in the APR were to result in radiation exceeding the limits for hazard level 1M, then a higher hazard level would have to be assigned.

An APR feature can comprise both hardware and software components: both components should be taken into account when determining the reliability of the APR feature.

### **D.5.3 Fault probability levels**

No system is 100 % fail-safe since there is always a non-zero probability that failures will occur. To quantify the risk of exposure to hazardous radiation, OFCS should be subject to fault analysis using recognized techniques.

### **D.5.4 Commonly used fault analysis techniques**

Commonly used fault analysis techniques are:

- simulation of those faults that could be expected under reasonably foreseeable conditions;
- failure modes effects and criticality analysis (FMECA, see IEC 60812 [1]);
- consequence analysis (see the IEC 61508 series of standards [5]).

### D.5.5 Failure modes effects and criticality analysis

If the chosen method of fault analysis is failure modes effects and criticality analysis then the probability of exceeding the accessible emission limits (under reasonably foreseeable circumstances) for the target hazard level should not exceed 500 FITs. It is recommended that the manufacturer or operator should carry out a fault analysis.

NOTE On the basis of 500 FITs and the estimated amount of time an engineer works on live fibres throughout his working life, the incident rate for the risk of injury to the eye is less than five HITs. (HITs is the number of hazard incidents per  $10^9$  h. For example in the UK, the Health and Safety Executive considers an occupational risk of less than 5,43 HITs for accidents to be trivial.)

#### D.5.5.1 Example of FMECA analysis for a simple laser drive circuit

The purpose of the analysis is to provide a quantitative measure of the probability of the optical power exceeding Class 1M AEL. The following example illustrates one recommended method.

Consider the simple circuit in Figure D.2.

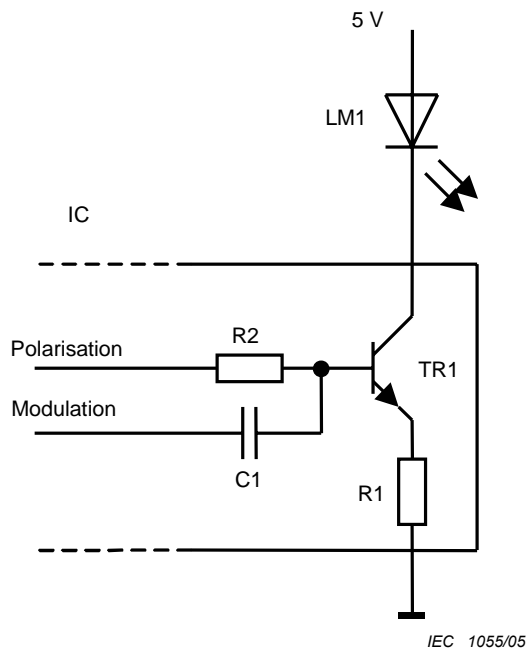

Figure D.2 – Simple laser drive circuit

##### D.5.5.1.1 Step 1: identify critical components

From circuit diagrams and parts lists, identify all the components likely to affect the *laser* module. Typically, these include mean power control circuitry, data modulator and threshold bias generator. Include automatic power reduction (APR) circuits in the analysis if the function of the APR is to achieve the intended classification, or if an APR component failure could cause a significant increase in the accessible power.

**D.5.5.1.2 Step 2: identify component failure modes**

Construct a table listing the components, their circuit identifier and their most likely failure modes as shown in Table D.3 below.

**Table D.3 – Identification of components and failure modes (example)**

Circuit ID	Component	Failure mode	Beta	Comments
LM1	Uncooled laser	Increase in output Decrease in output No output		
TR1	BFR 96 Mullard <500 mW NPN	Short circuit Open circuit		
R1	47R 2 % 0,25 W	Short circuit Open circuit Parameter drift		
R2	3K9 2 % 0,25 W	Short circuit Open circuit Parameter drift		
C1	0,47 µF 10 % 50 V	Short circuit Open circuit Parameter drift		

The US Department of Defense Reliability Analysis Center (RAC) publication [2] gives a list of likely failure modes. Include a column for comments and request an explanation of the likely outcome of the failure from the engineers consulted (see step 3).

**D.5.5.1.3 Step 3: determine beta values**

Circuit designers or repair engineers are the best people to consult for this task, since it requires a knowledge of how each component operates in the circuit.

Beta values depend on the criticality of the failure mode. A simple analysis assigns a probability figure to the beta value by considering just three categories, as illustrated in Table D.4.

**Table D.4 – Beta values (example)**

Does the failure mode cause the laser power to exceed Class 1M AEL?	Beta value
Yes	1
No	0
Maybe	0,5

The consulted engineers may be able to give better estimates for the beta values.

It is good practice to simulate fault conditions whenever possible.



#### D.5.5.1.4 Step 4: determine failure rates

The next step is to determine base failure rates for each component and apportion failure rates to failure modes. This information can be obtained from e.g. the following sources:

- data obtained by the analysis of in-service failures,
- BT Handbook of Reliability Data, HRD5 [3] (provides intrinsic failure rates for generic component types at the upper 60 % confidence limit),
- RAC publication [2] (lists the apportionment of failure rates to failure modes),
- Mil-HDBK 217 [17], and
- RAC publication NPRD [14].

For example, HRD5 lists the base failure rate ( $\lambda_{\text{base}}$ ) for a silicon small signal bipolar transistor as eight FITs, and the RAC publication lists the apportionment of failure modes ( $\alpha$ ) as 73 % for short circuits and 27 % for open circuits. Insert the values into the appropriate columns in the spreadsheet.

Determine the system failure rate by multiplying the columns horizontally and then add vertically. The overall failure rate represents the probability of the system exceeding the intended classification. This is illustrated in the following Table D.5.

**Table D.5 – Determination of failure rates (example)**

Circuit ID	Component	Failure mode	Beta	$\lambda_{\text{base}}$	$\alpha$	Product	Comments
LM1	Uncooled laser	Increase in output	1	500	0,05	25,0	May result from fibre movement
		Decrease in output	0	500	0,65	0	
		No output	0	500	0,30	0	Chip failure
TR1	BFR 96 Mullard <500 mW NPN	Short circuit	1	8	0,73	5,84	$I_{\text{laser}}$ limited by R1 (may still be safe, see below)
		Open circuit	0	8	0,27	0	
R1	47R 2 % 0,25 W	Short circuit	1	0,2	0,05	0,01	
		Open circuit	0	0,2	0,84	0	
		Parameter drift	0,5	0,2	0,11	0,01	
R2	3K9 2 % 0,25 W	Short circuit	1	0,2	0,05	0,01	
		Open circuit	0	0,2	0,84	0	
		Parameter drift	0,5	0,2	0,11	0,01	
C1	0,47 $\mu$ F 10 % 50 V	Short circuit	1	0,3	0,49	0,15	
		Open circuit	0	0,3	0,29	0	
		Parameter drift	0,5	0,3	0,22	0,03	
<b>Overall failure rate =</b>						31,06 FITs	

In this example (assuming 5 V power rail), the maximum laser current is limited by R1 to about 35 mA. This is unlikely to result in a 1,5 µm laser exceeding the Class 1M limit. In other cases, this is not always applicable, and reference should be made to the laser data sheet and individual component values.

In similar examples, where a component failure is significant only if accompanied by simultaneous independent failures in other components, a simple summation of FITs for these components may not be appropriate.

#### D.5.6 Consequence analysis

The IEC 61508 series of standards, *Functional safety of electrical/electronic/programmable electronic safety-related systems* [5], is one example of a standards-based approach that can be used to quantify the reliability of automatic power reduction (APR) safety systems. In the scheme specified by IEC 61508-1, requirements for a safety-related control system are categorised into one of four safety integrity levels (SIL). Depending on the SIL, different requirements apply. According to IEC 61508-1, hardware random failures and systematic failures have to be taken into account.

- Hardware random failures can be calculated using reliability data.
- Systematic failures take into account the possibility of design failures, failures due to environmental stress or influence and operational failures.

NOTE 1 The following is the SIL definition from IEC 61508-1: Discrete level (one out of possible four) for specifying the safety integrity requirements of the safety functions to be allocated to the electrical/electronic/programmable electronic safety-related systems, where safety integrity level 4 has the highest level of the safety integrity and safety integrity level 1 has the lowest.

NOTE 2 Where programmable electronic devices are used to control hazard levels it is recommended that the IEC 61508 series of standards should be applied. If the system is purely hardware it can be analysed using familiar techniques such as FMECA.

The standard provides several example methods how an “application sector”, like OFCS, could determine a recommended safety integrity level for specified product hazards. The following is a hypothetical and very conservative example of an approach for determining a SIL level. It is based on the “risk graph” method in Annex D of IEC 61508-5.

##### D.5.6.1 Example for consequence analysis

**Risk** (with no safety-related systems in place) is considered to be a function of the **frequency** of the hazardous event and the **consequences** of the event. For this example, a risk graph method is used to determine the SIL value. The figure below is the risk graph taken from one of the IEC 61508 standards.

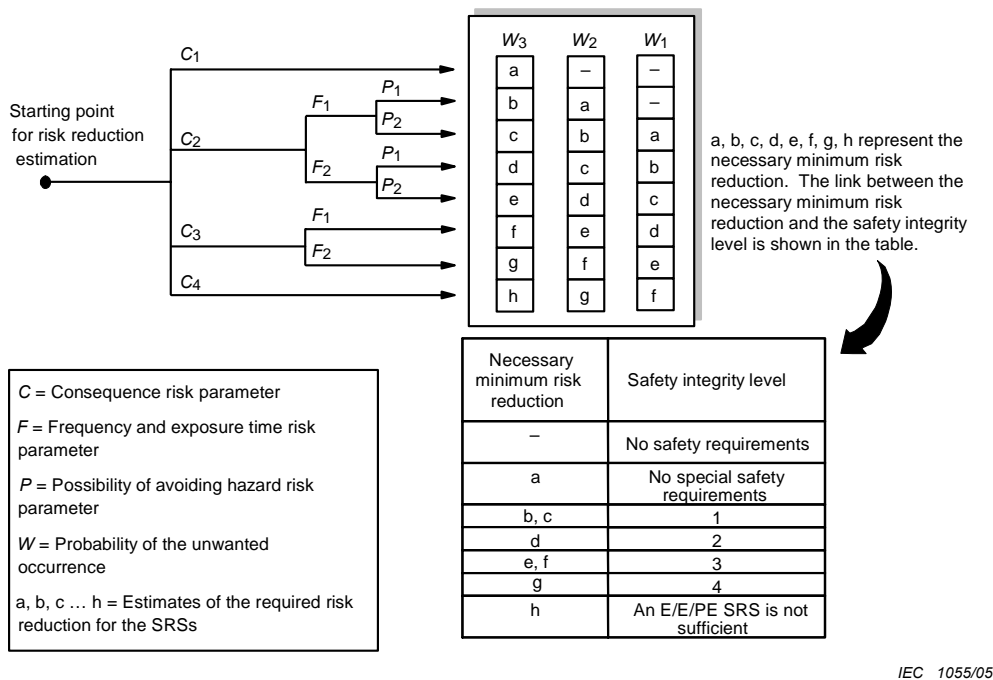

Figure D.3 – Risk graph example from IEC 61508-5 Clause D.5

**D.5.6.1.1 Step 1 – Consequence evaluation**

In the 61508 standard, four consequence levels are classified as shown in Table D.6 below. In the case of OFCS, for skin or eye damage, the consequence risk level could very conservatively be assigned  $C_2$ .

Table D.6 – Consequence classification from IEC 61508-5 Table D.1

Consequence Risk Level	Classification
$C_1$	Minor Injury
$C_2$	Serious permanent injury to one or more persons; death to one person
$C_3$	Death to several people
$C_4$	Very many people killed

**D.5.6.1.2 Step 2 – Frequency evaluation**

In the IEC 61508 series of standards, frequency and exposure time in the hazardous zone must be assessed and can be assigned one of two values as specified in Table D.7 below. A very conservative estimate for an OFCS example is an assignment of risk level  $F_2$ .

**Table D.7 – Frequency classification from IEC 61508-5 Table D.1**

Frequency of, and exposure time in, the hazardous zone – Risk Level	Classification
$F_1$	Rare to more often exposure in the hazardous zone
$F_2$	Frequent to permanent exposure in the hazardous zone

**D.5.6.1.3 Step 3 – Evaluation of the possibility of avoiding the hazard**

In the standard, the possibility of avoiding the hazardous event can be assigned one of two values as specified in Table D.8 below. In this example, an assignment of risk level  $P_1$  is made.

**Table D.8 – Possibility of avoiding hazard classification from IEC 61508-5 Table D.1**

Possibility of avoiding the hazardous event – Risk level	Classification
$P_1$	Possible under certain conditions
$P_2$	Almost impossible

**D.5.6.1.4 Step 4 – Evaluation of the probability of the hazardous event taking place without any safety-related systems**

The last assignment is the probability of the hazardous event taking place without any safety-related systems, i.e. probability of unwanted occurrence (see Table D.9 below). For this example the risk level range of  $W_1$ - $W_3$  is assigned.

**Table D.9 – Classification of the probability of the unwanted occurrence from IEC 61508-5 Table D.1**

Probability of the unwanted occurrence risk level	Classification
$W_1$	A very slight probability that the unwanted occurrences will come to pass and only a few unwanted occurrences are likely
$W_2$	A slight probability that the unwanted occurrences will come to pass and a few unwanted occurrences are likely
$W_3$	A relatively high probability that the unwanted occurrences will come to pass and frequent unwanted occurrences are likely

**D.5.6.1.5 Step 5 – Mapping onto the graph**

Mapping these parameters onto the risk graph (Figure D.3 above) yields, under the most conservative conditions, an assignment of a reliability level of SIL 1 for a skin or eye hazard. (The other methods described in the IEC 61508 series of standard also converge to SIL 1 using the same criteria.)

### D.5.6.1.6 Step 6 – Determination of the reliability of the APR system

In the following steps only SIL 1 has been considered. For SIL levels other than 1, refer to the IEC 61508 series of standards. For these SIL levels hardware random failures, hardware fault tolerance and the safe failure fraction should be taken into account according to IEC 61508-2.

The SILs are presented as two sets of number ranges – one set for high demand mode and one set for low demand mode for the safety device. After installation, optical fibre systems are seldom disturbed in any fashion that would unintentionally break or open the optical path. Therefore, there would be a very infrequent need for the automatic power reduction (APR) system to shut down or reduce the optical power. In the terminology of the IEC 61508 series, the APR would operate in a “low demand mode” (see definitions in Table D.10 below).

NOTE For example, mean time between failures for optical fibre cables have been determined to be in the range of 2 years to greater than 160 years. See Tables 1 and 2 in Cochrane and Heatley [18].

**Table D.10 – Modes of operation – Definitions from IEC 61508-4, 3.5.12**

Term	Definition
Mode of operation	Way in which a safety-related system is intended to be used, with respect to the frequency of demands made upon it, which may be either:
Low demand mode	where the frequency of demands for operation made on a safety-related system is no greater than one per year and no greater than twice the proof-test frequency; or
High demand or continuous mode	where the frequency of demands for operation made on a safety-related system is greater than one per year or greater than twice the proof-check frequency.
NOTE 1 High demand or continuous mode covers those safety-related systems which implement continuous control to maintain functional safety (e.g. a pressure regulator valve).	

For a SIL Level 1 system the target failure rate for a hazardous situation is between  $10^{-1}$  and  $10^{-2}$ . This target failure rate can be achieved by several solutions. Examples include APR, mechanical solutions and external risk reduction.

In this example, APR is chosen and the probability that APR fails to reduce the power should be less than 0,1 (see Table D.11).

**Table D.11 – SIL values from 7.6.2.9 of IEC 61508-1**

Safety integrity level	Low demand mode of operation (Average probability of failure to perform its design function on demand)
4	$\geq 10^{-5}$ to $< 10^{-4}$
3	$\geq 10^{-4}$ to $< 10^{-3}$
2	$\geq 10^{-3}$ to $< 10^{-2}$
1	$\geq 10^{-2}$ to $< 10^{-1}$

Concerning random hardware failures the SIL level or probability of failure of an automatic power reduction system is the APR unavailability. If the APR is continually monitored with alarms to alert to a malfunction of the APR or periodically tested, this unavailability is determined by both the APR equipment reliability and the operator repair time (mean time to repair or MTTR) in the event of an APR failure. Equipment reliability is often expressed as FIT rate (failures in  $10^9$  hours). Consider the following equation:

$$SIL\ level = APR\ unavailability = \frac{FIT\ rate \times MTTR}{10^9} \quad (D.1)$$

$$\text{thus } FIT\ rate = \frac{SIL\ level}{MTTR} \times 10^9$$

where

*SIL level* is failures/demand,

*MTTR* is mean time to repair in hours and

$10^9$  is the conversion from failure rate in failures/hour and FITs in failures/ $10^9$  hours.

The following figure D.4 shows the relationship between FIT rate and mean time to repair a failed safety system. The range for SIL level 1 safety systems has been highlighted.

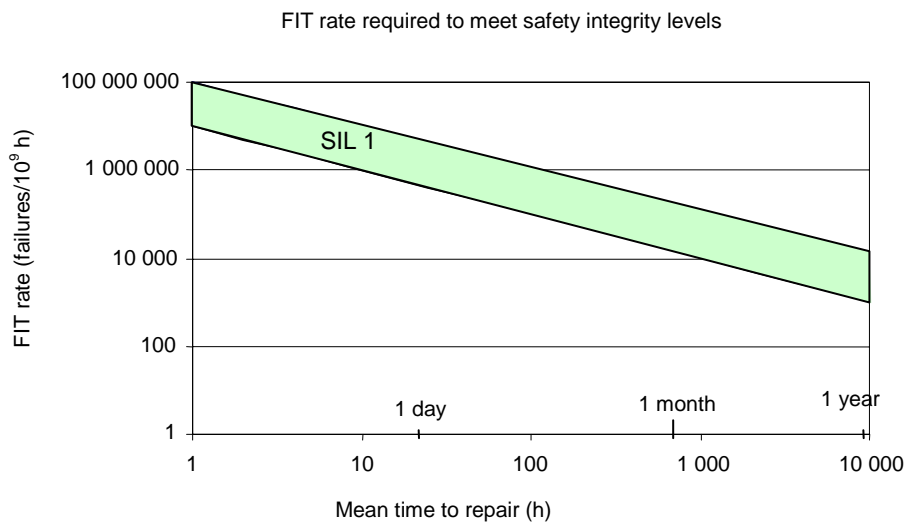

**Figure D.4 – Graph of FIT rate and mean time to repair**

#### **D.5.6.1.7 Step 7 – Reducing the risk from systematic failures**

For SIL 1, IEC 61508-2 and IEC 61508-3 highly recommend at least the following methods to reduce systematic failures:

- a) program sequence monitoring, e.g. watchdog, logical monitoring of program sequence, temporal monitoring with online check;
- b) software design using structured methods, e.g. JSD, MASCOT, SADT, Yourdon;

- c) measures against voltage breakdown, voltage variations, overvoltage, low voltage;
- d) separation of electrical energy lines from information lines;
- e) increase of interference immunity;
- f) measures against the physical environment, e.g. temperature, humidity, water, vibration, dust, corrosive substances;
- g) measures against temperature increase, e.g. temperature sensor, fan control, thermal fuse, temperature alarm, forced air cooling and status indication;
- h) spatial separation of multiple lines carrying duplicated signals;
- i) modification protection, e.g. plausibility check of signals or detection by automatic start-up tests.

For further information and details to the above mentioned methods see IEC 61508 [5], Parts 2 and 3.

#### D.5.6.1.8 Fit rate determination

The reliability of the APR system is a continuum that is dependent on the responsible use and maintenance of these systems. For APR functions with a very low FIT rate there is no maintenance of the APR function needed if the product is taken out of service within the specified lifetime of the APR function. For all other systems the APR unavailability, and consequently the FIT rate, is dependent on the possibility that any failure of the APR can be detected and the operator alerted in a reasonable time for repair, as well as the responsiveness of the operator to respond to any alarms that would indicate a failure in the APR.

Since equipment manufacturers do not have control over the maintenance of their systems, it may be useful to propose specific FIT rates – rather than the combination of SILs and mean time to repair (Figure D.4). Manufacturers are likely to supply APR systems that either 1) have frequent or continuous diagnostic testing (proof testing) or 2) are not tested or monitored. For continuous diagnostic testing, monitoring, and alarming it is likely that a failure in optical fibre communications systems would be repaired within one day, therefore MTTR = 24 hours. Systems that do not test the safety-related systems may operate unattended for long periods, but sometimes these systems are likely to be upgraded, repaired, tested or replaced every couple of years. Therefore, the mean time to repair can sometimes be considered to be ( $10^4$  h), or MTTR =  $10^4$  h, which is in the order of one year.

**Table D.12 – Determination of equipment monitoring classification**

Diagnostic testing and monitoring of safety-related system	Classification	Mean time to repair
M <sub>1</sub>	Frequent or continuous diagnostic testing and monitoring performed on the safety-related system	1 day (24 h)
M <sub>2</sub>	No monitoring, but frequent diagnostic testing	1 year ( $10^4$ h)
M <sub>3</sub>	No monitoring and no testing; system is taken out of service before the specified end of life of the APR	20 years ( $2 \times 10^5$ h)

With this information, the FIT rate can now be determined. As an example, consider a communication system operating at 1 550 nm where the optical power under normal operation (no fault detected) exceeds Class 1M but is below the upper limit of Class 3B. Let us say that we wish to enable the OFCS to operate in an unrestricted location. To facilitate this it is necessary for the radiation accessible under reasonably foreseeable fault conditions to be limited to hazard level 1, and, given the Class of laser emitter, an APR system is needed. The maximum permitted FIT rate should be assigned as the upper limit of a SIL 1 level system. From Equation (D.1) and Figure D.4 above, it can be seen that the minimum requirement (i.e. the maximum acceptable FIT rate) would be  $4 \times 10^6$  FITs for a continuously diagnosed system with a mean time to repair (MTTR) of 24 h,  $10^4$  FITs for a system with a MTTR of 1 year, and 500 FITs for a system without continuous diagnostics.

FIT rate specifications can similarly be determined for other consequence risk levels (see the IEC 61508 series).

**Table D.13 – FIT rates from example above**

Safety integrity level	Consequence	FIT Rate		
		M <sub>1</sub> (Continuous diagnostics)	M <sub>2</sub> (Frequent testing)	M <sub>3</sub> (No monitoring)
SIL 1	Serious permanent injury to one or more persons; death to one person – e.g. retinal damage, small fire (C <sub>2</sub> )	<4x10 <sup>6</sup>	<10 <sup>4</sup>	<500

## D.6 Suggested working practices

The following working practices may be regarded as examples of good practice, and are recommended when working with OFCS. Different working practices may apply in different circumstances.

### D.6.1 General working practices

The following working practices may be regarded as good practice when working on an OFCS:

- |                                 |   |
|---------------------------------|---|
| Viewing fibre                   | Do not stare with unprotected eyes or with any unapproved collimating device at the fibre ends or connector faces, or point them at other people.   |
| Viewing aids                    | Use only approved filtered or attenuating viewing aids.   |
| Fibre ends (single or multiple) | Any single or multiple fibre end(s) found not to be terminated (for example, matched, spliced) should be individually or collectively covered with material appropriate for the wavelength and power when not being worked on. They should not be readily visible and sharp ends should not be exposed.<br><br>Suitable methods for covering include the use of a splice protector or tape. Always attach end caps to unmated connectors. |



Ribbon fibres	Do not cleave ribbon fibres as an unseparated ribbon, or use ribbon splicers, unless authorized.
Test cords	When using optical test cords, the optical power source should be the last to be connected and the first to be disconnected.
Fibre off-cuts	Collect all fibre off-cuts and dispose of them in an approved container. The container itself should be disposed of in an approved manner.
Maintenance	Follow only approved instructions for operating and maintaining the system being worked on.
Cleaning	Use only approved methods for cleaning and preparing optical fibres and optical connectors.
Modification	Do not make any unauthorized modifications to any OFCS or associated equipment.
Board extenders	Board extenders should not be used on optical transmitter cards. Do not power optical sources when they are outside transmitter racks.
Label damage	Report damaged or missing optical safety labels to line management.
Key control	For equipment with key control, the keys should be placed under the control of a person appointed by management who should ensure their safe use, storage and overall control. Spare keys should be retained under strict control procedures by a nominated line manager.
Test Equipment	Use test equipment of the lowest class necessary and practical for the task. Do not use test equipment of a higher class than the location hazard level.
Signs	Area warning signs are required for locations exceeding hazard level 1M. Area signs may be displayed in locations of lower classification.
Alarms	System alarms, especially those indicating that the APR or any other safety system is inoperable, should be responded to so that repair takes place within specified time.

#### **D.6.2 Live working practices for hazard levels 1, 1M, 2, 2M and 3R**

When working on live/energized systems (e.g. when optical signals are being transmitted along the fibre of an OFCS) it is recommended that the working practices listed in D.6.1 be used.

#### **D.6.3 Working practices for hazard level 3B**

Working on an energized system (sometimes referred to as 'live working') in locations with hazard level 3B allocated is not recommended.

Responsible and adequate OFCS safety and training programmes should be established and maintained by management. Personnel engaged in the installation and servicing of OFCS should observe all rules, and report to management any potentially unsafe conditions or abnormal exposures to optical radiation.

If working on energized systems in locations with hazard level 3B is not permitted (as described above), then the following working practices should be used:

- all general practices defined in D.6.1;
- the equipment generating the optical radiation should be de-energized, thereby de-energizing the OFCS (as detailed in D.6.4);
- check that there is no optical power in the fibre by using an approved optical power meter capable of withstanding the highest power transmitted in the system without damage;
- cover the ends of all exposed fibres not being worked on. Always ensure unmated connectors are appropriately attenuated, using the in-built connector shutter mechanism or an end cap;
- use only indirect viewing aids (for example televised or shadow imaging splicing machines). Do not use microscopes or eye loupes without authorization;
- when using optical test cords, the optical power source should be the last to be connected and the first to be disconnected.

#### **D.6.4 Formal power-down and power-up procedure for hazard level 3B**

When de-energizing an OFCS (if working on energized systems is not permitted), the following procedure should be adopted.

- a) A nominated person at an optical power source should:
  - have been trained to an appropriate level on the type of equipment which has to be switched on and off;
  - be conversant with the instructions and safety requirements relating to the previous paragraph and with any additional local instructions and circumstances;
  - have a responsible attitude to safety.
- b) Nominated persons should be appointed by line management and be notified of their appointment.
- c) A list of nominated persons at each installation should be recorded and prominently displayed.
- d) Before starting work, the person authorized to carry out the work (the originator) should:
  - contact a nominated person at the appropriate optical power source and request that the power on the relevant fibres be switched off;
  - on duplex systems, a nominated person should be contacted at each end;
  - on being informed that the power has been switched off, complete the necessary forms, which should be retained by the originator. These forms need not be completed if the originator and the nominated person are one and the same;
  - verify (with an energized/live fibre identifier or optical power meter) that the power is off;
  - on completion of the work, inform a nominated person at the appropriate optical power source(s).

- e) On receipt of a request from an originator to switch off an optical power source, the nominated person should:
- record the time and date of the request and the details of the originator. Forms should be kept on file at the location of the optical source;
  - switch off the appropriate power source (with key control, if fitted);
  - complete the warning label and affix it to the appropriate station equipment at the point of disconnection, for example equipment rack, distribution frame; a label should be attached for each originator;
  - contact the originator and give him the job number and the time that the source was switched off;
  - on being informed that the work has been completed, record the details appropriately and remove the warning label from the equipment before re-energizing the source. When more than one originator requires the same power source to be switched off, the source should not be re-energized before all work is completed.

### D.7 Maximum output power during shutdown

Table D.14 lists the maximum output power (mW), during the shutdown time, for single mode OFCS which shut down to lower hazard level limits in 1 s for unrestricted locations and 3 s for restricted and controlled locations (see 4.8.2). Engineering requirements as outlined in Annex B should be employed as appropriate to that lower hazard level.

The equation used to derive Table D.6 was:

$$NOHD = \frac{\omega_0 \pi d}{2\sqrt{2}\lambda} \times \frac{1}{\sqrt{\ln \left( \frac{P}{P - \frac{\pi d^2 MPE}{4t}} \right)}}$$

An alternative form of this equation is:

$$P = \frac{\pi d^2 MPE}{4t} \times \frac{1}{1 - \exp \left[ -0,125 \left( \frac{\pi \omega_0 d}{\lambda NOHD} \right)^2 \right]}$$

where

$\omega_0$  is the mode field diameter ( $1/e^2$  power density) (m);

$P$  is the total power in fibre (W);

$d$  is the limiting aperture diameter (m);

$MPE$  is the maximum permissible exposure ( $Jm^{-2}$ );

$NOHD$  is the nominal ocular hazard distance (m);

$t$  is the shutdown time (s);

$\lambda$  is the wavelength (m).

**Table D.14 – Examples of power limits for optical fibre communication systems having automatic power reduction to reduce emissions to a lower hazard level**

Wavelength nm	Fibre mode field diameter $\mu\text{m}$	Maximum power output unrestricted mW	Maximum power output restricted mW	Maximum power output controlled mW	Shutdown times s	Measurement distance m
980	7	9,4	9,4	–	1	0,1
980	7	N/A	7,2	–	3	0,1
980	7	N/A	–	39	3	0,25
1 310	11	78	78	–	1	0,1
1 310	11	N/A	59	–	3	0,1
1 310	11	N/A	–	314	3	0,25
1 400 ... 1 500	11	1 598	1 598	–	0,3	0,1
1 400 ... 1 500	11	650	650	–	1	0,1
1 400 ... 1 500	11	N/A	389	–	2	0,1
1 400 ... 1 500	11	N/A	288	–	3	0,1
1 400 ... 1 500	11	N/A	–	2 403	2	0,25
1 400 ... 1 500	11	N/A	–	1 774	3	0,25
1 550	11	2 539	2 539	–	0,5	0,1
1 550	11	1 273	1 273	–	1	0,1
1 550	11	N/A	639	–	2	0,1
1 550	11	N/A	428	–	3	0,1
1 550	11	N/A	–	2 640	3	0,25

NOTE 1 The fibre parameters used are the most conservative case. Listed figures for  $\lambda = 1\ 310\ \text{nm} \dots 1\ 550\ \text{nm}$  are calculated for a fibre of 11 microns mode field diameter (MFD) and those for  $\lambda = 980\ \text{nm}$  are for 7 microns MFD.

Many systems operating at 1 550 nm with the use of erbium doped fibre amplifiers (EDFAs) pumped by 1 480 nm or 980 nm lasers use transmission fibres with smaller MFDs. For example, 1 550 nm dispersion shifted fibre cables have upper limit values of MFD of 9,1 microns. In this case, the maximum power outputs for unrestricted and restricted areas at 1 480 nm and 1 550 nm are 1,44 times the values in Table D.14, and those for controlled areas at 1 480 nm and 1 550 nm are 1,46 times the values in same table.

NOTE 2 Times given in the table are examples; shutdown at any shorter time than the maximum is permissible, and may permit the use of higher powers (the maximum times are 1 s for unrestricted locations and 3s for restricted and controlled locations, respectively.)

## **Annex E** (informative)

### **Guidance for service and maintenance**

#### **E.1 Tests and measurements**

**E.1.1** Tests, measurements and operations in cable ducts and switching centres should be considered as service or maintenance operations. Wherever possible, diagnostic tests should be carried out in such a way as not to increase the hazard level at any location. It may be necessary to have administrative controls which, in some cases, may involve a permit to work system. When connecting test equipment, due regard should be given to establishing the actual power levels introduced into the system in assessing the hazard.

**E.1.2** The operating organization should develop and maintain clearly defined conditions under which the automatic power reduction feature can be overridden.

When the automatic power reduction feature has been overridden, the hazard level should be reassessed by the operating organization. The appropriate safety precautions described in 5.2 and its associated subclauses should be taken as appropriate to the reassessed hazard level.

**E.1.3** Any viewing optics for fibre examination and splicing should be selected so that they reduce exposure to below the relevant maximum permissible exposure (MPE) and should be approved for use by the operating organization.

NOTE The marking of approved viewing optics with a label by the operating organization may be an acceptable solution.

**E.1.4** Wherever reasonably practical, servicing, maintenance and repair should be carried out with no power propagating in the fibre. Where this is not reasonably practicable, the system should be operated at the lowest power consistent with the functional need.

**E.1.5** The operating organization should establish work practices preventing human exposure to radiation in excess of the relevant MPE.

#### **E.2 Safety precautions**

##### **E.2.1 General remarks**

**E.2.1.1** In locations where, during service or maintenance, optical or laser radiation above the MPE levels may be encountered (e.g. during switching, in controlled locations), appropriate eye protection should be provided.

**E.2.1.2** Before working on any optical fibre cable or system, the end-user should check the hazard level at accessible locations. In the case of systems that are installed and activated, the hazard level should be identified at accessible locations by warning labels. Precautions appropriate to the hazard level should be taken on systems that are known to be, or could become, operational. During installation, hazard level labels may not have been provided yet and, in their absence, precautions appropriate to the classification of any transmitters or test equipment containing optical sources connected to the fibre should be used.

**E.2.1.3** During the installation or testing of an optical fibre cable or network it is recommended that only test equipment having an output designated hazard level 1, 1M, 2 or 2M per IEC 60825-2 or Class 1, 1M, 2 or 2M per IEC 60825-1 be used.

For optical fibre communications systems located in a restricted location or a controlled location it is possible to use test equipment with higher optical output powers, providing the accessible fibre ends and connectors at all locations are secured and labelled with the appropriate hazard level before testing proceeds.

**E.2.1.4** Entry points to controlled areas with a hazard level of 3B should have:

- a sign bearing the warning label according to Figure 14 in IEC 60825-1 and the explanatory label of Figure 15 of IEC 60825-1 bearing the words "Hazard level 3B";
- a sign limiting access to authorized persons only and explaining the existence of a potential hazard.

**E.2.1.5** Each person engaged in the operation, installation or service of an OFCS should:

- observe all rules, procedures and practices established for the safe operation of OFCS;
- immediately notify the supervisor of conditions or practices that have the potential to cause personnel injury or property damage;
- immediately report to the supervisor any known or suspected abnormal exposure to optical radiation.

## **E.2.2 Precautions in locations with hazard levels 1M, 2M, 3R and 3B**

**E.2.2.1** Where possible, optical transmission or test equipment should be shut down, put into a low-power state or disconnected before any work is done on exposed fibres, connectors etc. In that case, unintentional switching on should be prevented by a remote control switch or another suitable method. The status of the line (power on or off) should be clearly indicated.

**E.2.2.2** Persons having access to any energized fibre end or connector end should be instructed not to view such points directly. Under all circumstances, only those viewing aids which provide the appropriate level of attenuation should be used.

**E.2.2.3** Only staff who have attended an optical fibre safety training course should be permitted to work on OFCS in a location with hazard level 3B.

**E.2.2.4** Staff installing, operating or maintaining OFCS and any associated test equipment in locations with hazard level 3B should ensure that untrained personnel are adequately protected.

**E.2.2.5** It is possible that high loss points in the system could suffer from high temperatures when extremely high power levels (hundreds of mW to several W) are injected into the fibre.

NOTE An example of such a system is one that uses distributed Raman amplification technology.

The high temperature may lead to dangerous situations in equipment and offices. Therefore, in systems that normally transmit extremely high power the following action is recommended: connectors should be cleaned very carefully so that the loss induced by connectors, splices or bending at any point is reduced as far as possible.

### **E.2.3 Training programme**

The employer of staff installing or maintaining OFCS should establish and maintain an adequate programme for the control of fibre optic hazards. Safety and training programmes should be instituted for staff working on fibre optic communication systems with a hazard level of 3B. Such programmes should be directed by individuals competent in the field of laser and OFCS safety. The programmes should provide, as a minimum:

- background information on OFCS;
- safety information concerning the laser classification system and hazard levels.

## **Annex F** (informative)

### **Clarification of the meaning of “hazard level”**

In this annex, the difference between “laser class” defined in IEC 60825-1 and “hazard level”, defined in IEC 60825-2 is further clarified.

#### **F.1 Class**

The word “class” refers to a scheme by which, based on emission levels, a product or internal emitter can be grouped with respect to its safety. These levels are described in the accessible emission limit tables in IEC 60825-1. Classes range from Class 1, which is safe under reasonably foreseeable conditions, to Class 4, which is potentially the most hazardous case. In IEC 60825-1, the classification of products is based on reasonably foreseeable operating conditions including single fault conditions.

#### **F.2 Hazard level**

“Hazard level” is a term used in this standard which refers to the potential hazard from laser emissions at any location in an end-to-end fibre optic communication system that may be accessible during use or maintenance or in the event of a failure or fibre disconnection. The assessment of the hazard level uses the class accessible emission limit tables described in IEC 60825-1. The assessment of hazard level is described in 4.8.1. The assessment can be an actual measurement or be based upon calculation of emitting powers and known time constants.

Annex A of this standard gives the following additional clarification: “A whole OFCS will not be classified in the same way as required by IEC 60825-1. This is because, under intended operation, the optical radiation is totally enclosed and it can be argued that a rigorous interpretation of IEC 60825-1 would give a Class 1 allocation to all systems, which may not reflect the potential hazard accurately.” Based upon this statement, a complete OFCS can be regarded as a Class 1 laser product because, under normal conditions, the emissions are completely enclosed (like a laser printer) and no light should be emitting outside the protective housing. It is not until the fibre becomes broken or an optical connector is unplugged that someone might be exposed to a level of optical radiation which is potentially hazardous (if the internal emitters or amplifier outputs are of high enough power).

Therefore, for each optical output port, the hazard level must be assessed. The hazard level limits are dependent on the “dominant” wavelength range, taking into consideration that IEC 60825-1 defines different limits for different wavelength ranges. Details can be found in IEC 60825-1. Furthermore, this standard allows the use of automatic power reduction (APR) techniques to achieve a lower (less hazardous) hazard level based on the normal power in the fibre and the speed of automatic power reduction.



### **F.3 Rationale to definitions 3.1, 3.4 to 3.11 and to Clause 4**

Large portions of OFCS can sometimes be classed as "not accessible under reasonably foreseeable conditions".

### **F.4 Rationale to 4.8.1 and 4.8.2**

The philosophy of these subclauses is based on assumptions that already exist in Parts 1 and 2 of IEC 60825.

The clause requires that the MPE not be exceeded if any person is exposed to radiation emerging from the port or fracture from the instant of break or disconnection. The power is assumed to remain constant at its maximum value until the shutdown time has expired.

#### *a) Unrestricted locations:*

The 1 s shutdown for unrestricted areas is consistent with 4.8.1 of IEC 60825-2, which states that "...the assessment of the hazard level shall take place 1 s after the reasonably foreseeable event...". The 100 mm distance is consistent with Table 10 of IEC 60825-1. Even if a fibre is intentionally cut, it is highly unlikely that, within 1 s, a person can get within 100 mm and position collimating optics be adversely exposed. Also, one must keep in mind that optical signals are attenuated as they move down the fibre, so the output at the failure in the unrestricted area may be considerably lower than at the transmitter or amplifier.

#### *b) Restricted locations:*

The 3 s shutdown for restricted areas is also consistent with 4.8.1, if one assumes that any failure of the system within a restricted area would be of an accidental nature and the 3 s limit for shutdown would be an acceptable time period "after the reasonably foreseeable event". It is also highly unlikely that, in this time period, a person can get within 100 mm and position collimating optics be adversely exposed. One must also keep in mind that optical signals are attenuated as they move down the fibre, so the output at the failure in the restricted area may be considerably lower than at the transmitter or amplifier.

#### *c) Controlled locations:*

Persons working in locations with controlled access must have received adequate training in laser safety, which should include an understanding that viewing a broken fibre should not be undertaken unless the system has been properly inactivated.

### **Rationale to Clause D.5**

Annex D is informative. The use of the term "recommended" may be incorrectly construed as forbidding the use of alternative methods of analysis. The method of fault analysis and the adoption of a suitable safety level is the prerogative of the user.

## Bibliography

- [1] IEC 60812, *Analysis techniques for system reliability – Procedures for failure mode and effects analysis (FMEA)*
  - [2] *Failure Mode/Mechanism Distributions 1991*, FMD-91. Reliability Analysis Center, US Dept of Defense, 1991. [Prepared by: Reliability Analysis Center, PO Box 4700, Rome NY]
  - [3] *BT Handbook of Reliability Data for Components Used in Telecommunications Systems*, 1995, Issue 5 [Copies available from: ILI Index House, Ascot, Berkshire SL5 7EU]
  - [4] UKAS Document NIS 20: *Uncertainties of Measurement for Electrical Product Testing Draft 2*, Jan 1992
  - [5] IEC 61508 (all parts), *Functional safety of electrical/electronic/programmable electronic safety-related systems*
  - [6] IEC 60794-1-1, *Optical fibre cables – Part 1-1: Generic specification – General*
  - [7] IEC 60794-1-2, *Optical fibre cables – Part 1-2: Generic specification – Basic optical cable test procedures*
  - [8] IEC 60794-2, *Optical fibre cables – Part 2: Indoor cables – Sectional specification*
  - [9] IEC 60794-3, *Optical fibre cables – Part 3: Sectional specification – Outdoor cables*
  - [10] IEC 60794-4-1, *Optical fibre cables – Part 4-1: Aerial optical cables for high-voltage power lines*
  - [11] IEC 60794-3-10, *Optical fibre cables – Part 3-10: Outdoor cables – Family specification for duct and directly buried optical telecommunication cables*
  - [12] IEC 60794-3-20, *Optical fibre cables – Part 3-20: Outdoor cables – Family specification for optical self-supporting aerial telecommunication cables*
  - [13] IEC 60950-1:2001, *Information technology equipment – Safety – Part 1: General requirements*
  - [14] *Nonelectronic parts reliability data 1995*, NPRD-95. Reliability Analysis Center (US Dept of Defense, 1995. [Prepared by Reliability Analysis Center, PO Box 4700, Rome NY]
  - [15] ITU-T Recommendation G.664, *Optical safety procedures and requirements for optical transport systems*
  - [16] IEC 60825-12, *Safety of laser products – Part 12: Safety of free space optical communication systems used for transmission of information*
  - [17] MIL-HDBK-217F, *Reliability Prediction Of Electronic Equipment*
  - [18] COCHRANE, P. and HEATLEY, DJT. Reliability Aspects of Optical Fibre Systems & Networks. *BTTJ Special Issue on Future Telecommunication Systems & Networks*, No. 2, April 1994, Vol 12, pp. 77-92,  
[also found at: <http://innovate.bt.com/people/heatledj/papers/reliability/reliability>]
-

ISBN 2-8318-8963-4



9 782831 889634

---

**ICS 31.260; 33.180.01**

---

Typeset and printed by the IEC Central Office  
GENEVA, SWITZERLAND