



BRIGHT TECHNOLOGY INDUSTRIAL LTD

深圳必锐科技有限公司

ABOUT US



COMPANY PROFILE

Shenzhen Bright Technology Industrial Limited is an innovative enterprise established in 2010. Our factory is 3000 square meters with more than 150 employees.

We are specialized in R&D, producing, selling and after-sell service of flexible LED strip, LED grow light, LED neon light, LED UV light, LED bar light, etc.

We are located in Longhua district, the center of Shenzhen city, which has very strong infrastructure for raw material supply, factory production, technical consulting and logistics service.

Our staff are all good trained and have rich experience in LED business. We are dedicated in providing "professional, high quality, innovative and perfect" products and one-stop customer service, and available to offer products according to the customers' requirements at any time to ensure superior customer satisfaction.

We have obtained a serial certificate for our products and company, including CE, RoHS, TUV, UL, BIS, ISO9001, etc. A variety of payment methods and shipping methods are available to meet different demands of customers all over the world. We are highly trusted and praised by our customers.

In addition to the regular products, we also provide OEM and ODM service. Besides selling the products in our catalog, we are looking forward to your good new idea and expecting jointly developing new products with you.

We sincerely hope that with our good reputation at home and abroad, we can establish long-term partner relation and mutually beneficial cooperation, and achieve substantial development with you. Looking forward to your visit at any time.

公司介绍

深圳必锐科技有限公司是专业从事新型半导体LED电光源与LED照明应用相结合的高新技术企业，集研发、生产、销售、服务为一体。公司拥有一批专业、精干、务实、精通LED半导体新光源的一流技术开发团队和国际视野市场的开拓人才。公司秉承“诚信、创新、共赢”的经营理念，积极进取，稳步发展，为用户提供高品质的LED照明产品和优质的售后服务。

实现节能降耗，技术进步是关键。目前必锐仍在不懈的努力，以诚信、务实、创新的精神不断的研发适用各种场所的LED系列新产品。公司依照ISO9001国际质量标准体系管理运作，建立了一套严谨的品质管理和保证体系。为国内外客商提供技术支持、产品配套、备品配件及相关服务。

必锐科技有限公司在LED半导体照明领域内拥有多项自主知识产权的技术，结合最新的电子科技推出了一系列的LED照明产品，功率从1W-200W广泛用于城市景观、公司办公楼、工业厂房、机场、车站、地铁、学校、医院、商场、超市、居民小区、街道、园林公园、消防警示、户外旅游等各种场合中使用。目前公司的核心产品主要是植物灯、线条灯、灯带、杀菌灯、智能化LED照明等产品，该系列产品已经在国内外广泛应用，并得到一致的好评。

必锐科技秉承着技术是生命、质量是市场、交期是信用、成本是能力、服务是绩效的经营理念。用优质的产品满足社会对绿色节能光电产品的新需求，立志成为中国LED照明产业的领跑者。我们热切希望与国内外伙伴建立长期合作的伙伴关系，共创多赢市场。

ABOUT US



CE RoHS ISO9001:2015 SGS



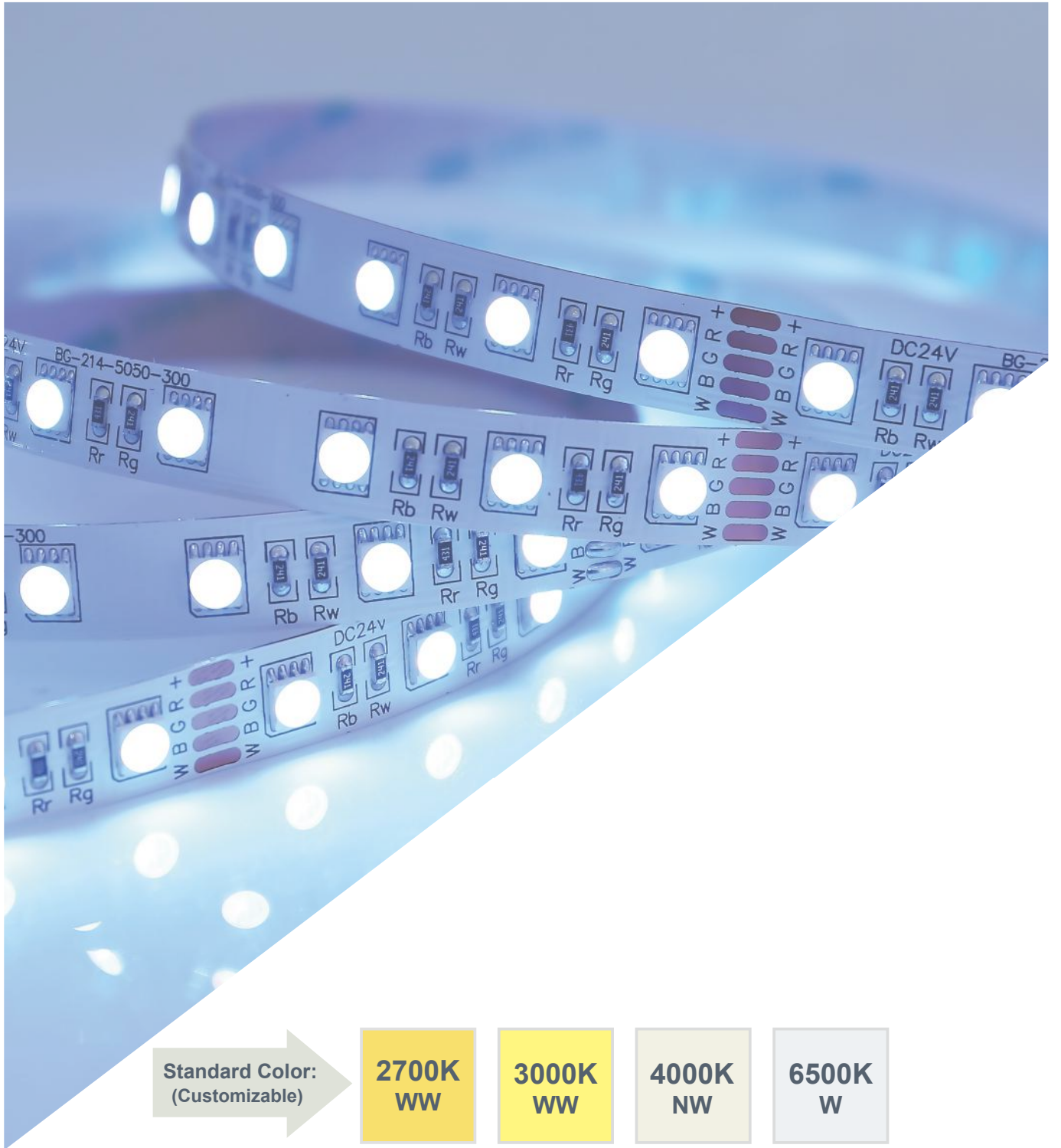





Standard Color: (Customizable)	2700K WW	3000K WW	4000K NW	6500K W
	CCT	RGB	RGBW	RGB CCT
IP Grade:	IP20	IP65	IP66	IP68

LED Strip:	High Efficiency	01-02
	SMD2835	03-04
	SMD5050	05-06
	RGB(W/WW)	07-08
	SMD3014	09-10
	SMD3528	11-12
	SMD2220	13-14
	SMD2110	15-16
	SMD3535	17-18
	Addressable	19-20
	DMX512	21-22
	Constant Current	23-24
	Narrow	25-26
	High Voltage	27-28
	UV	29-30
	Kit	31-32
FCOB LED Strip:	Roll To Roll	33-34
	Narrow	35-36
	Single Color	37-38
	Tunable White	39-40
	RGB(W/WW)	41-42
	Constant Current	43-44
	Mini Cutting	45-46
	Free Cutting	47-48
	Addressable	49-50
	Side View	51-52
	High Voltage	53-54
LED Neon Light:	Side View	55-56
	Top View	57-58
	Round View	59-60
	Free Style	61-62
	Super Long	63-64
	Mini Size	65-66
LED Sheet:	Long Style	67-68
	Square Style	69-70
	Lens Style	71-72
Flex LED Wall Wash Light	73-74
LED Grow Light:	Flowing Gold Series	75-76
	Eagle Series	77-78
	Gold Eagle Series	79-80
	Cobra Series	81-82
	Tube Series	83-84
	Downlight Series	85-86
	Spotlight Series	87-88
	Pendant Light Series	89-90
Accessories	91-94

High Efficiency



SMD2835

	1800
	2200
	2700
	3000
	4000
	5000
	6000
	8000
	10000
	20000
	Red
	Green
	Blue

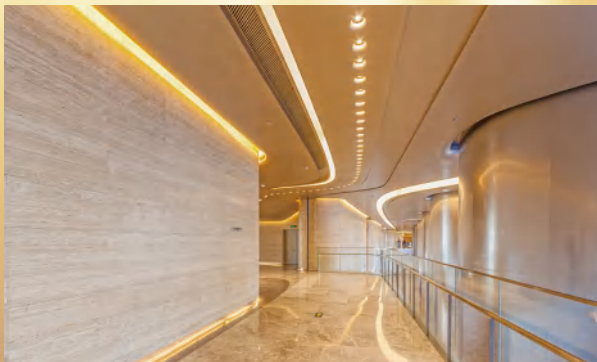
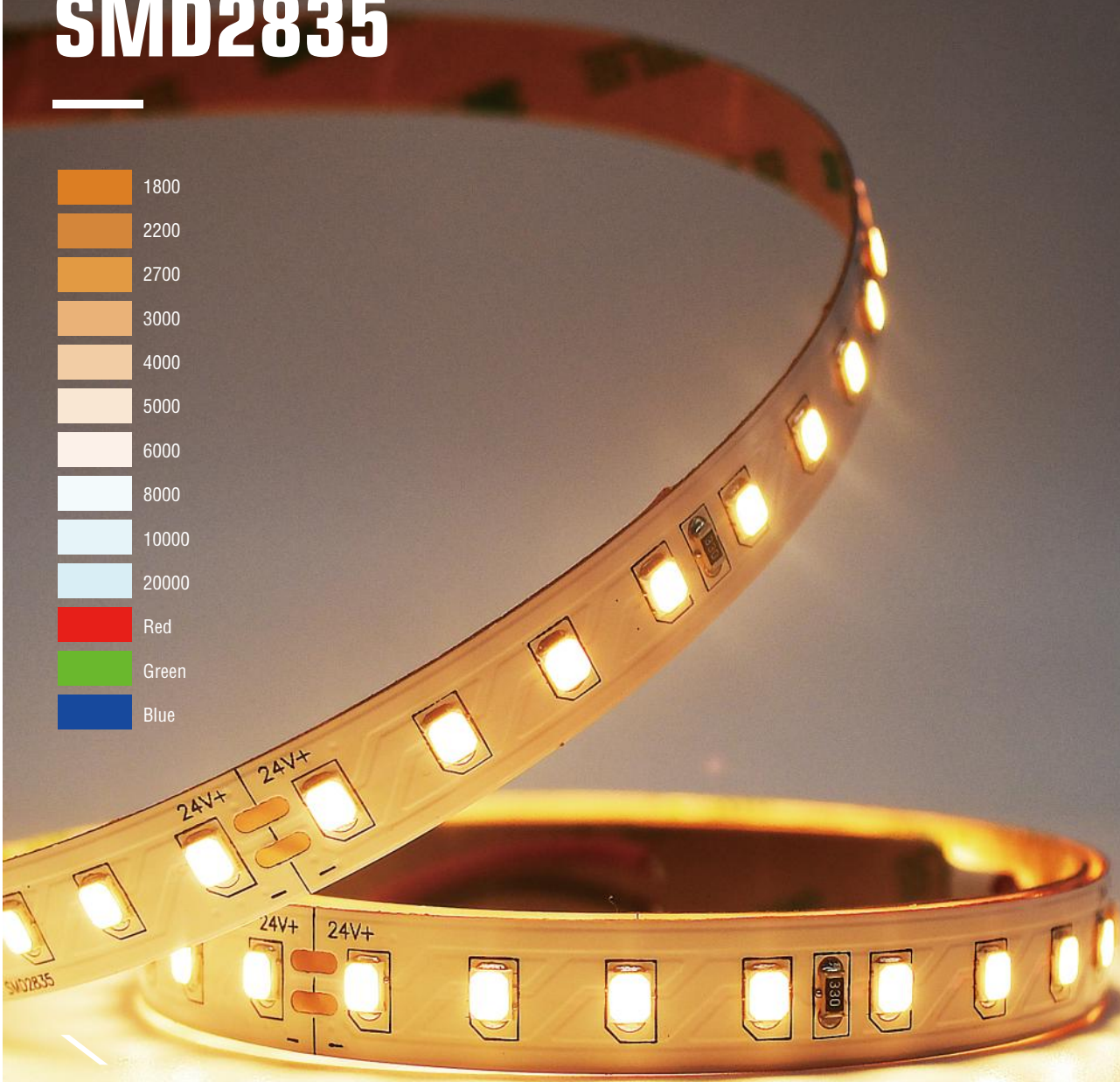













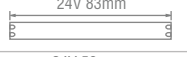



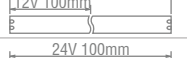

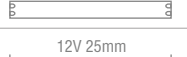
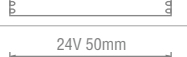
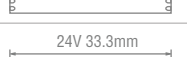

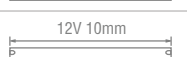

Application:

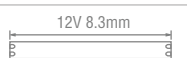
Interior design / 室内设计

Architectural design / 建筑设计

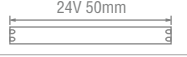
Advertisement project / 广告项目

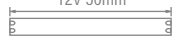
Display design / 展示设计

NO. 型号	VOLTAGE 电压(DC)	POWER 功率	LED QTY. 灯珠数量	PCB Width 板宽	CRI 显指	LUMEN FLUX 流明	Light Efficiency 光效	DIMENSIONS 剪切长度
BG-240-2835-300-S	12V	7.2 W	60 pcs/m	6mm	>90	590 Lm	86 Lm/w	
BG-240-2835-300	12V/24V	14.4 W	60 pcs/m	8mm	>90	1150 Lm	86 Lm/w	
BG-310-2835-350	DC24V	8 W	70 pcs/m	8mm	>90	960 Lm	120 Lm/w	
BG-249-2835-420	DC24V	9 W	84 pcs/m	6mm	>90	830 Lm	92 Lm/w	
BG-241-2835-600	12V/24V	19.2 W	120 pcs/m	10mm	>90	1570 Lm	86 Lm/w	
BG-256-2835-600	12V/24V	14.4 W	120 pcs/m	8mm	>90	1180 Lm	86 Lm/w	
BG-257-2835-600	24V	7.2 W	120 pcs/m	6mm	>90	610 Lm	86 Lm/w	
BG-311-2835-700	24V	14 W	140 pcs/m	8mm	>90	1680 Lm	120 Lm/w	
BG-242-2835-300-CCT	12V/24V	14.4 W	60 pcs/m	10mm	>90	1150 Lm	86 Lm/w	
BG-244-2835-600-CCT	12V/24V	19.2 W	120 pcs/m	12mm	>90	1570 Lm	86 Lm/w	
BG-224-2835-300	24V	12W	60 pcs/m	10mm	>90	1080 Lm	90 Lm/w	
BG-225-2835-600	12V	9W	120 pcs/m	6mm	>90	855 Lm	95 Lm/w	
BG-226-2835-600	12V	12W	120 pcs/m	8mm	>90	1080 Lm	90 Lm/w	
BG-227-2835-600	24V	18 W	120 pcs/m	10mm	>90	1550 Lm	85 Lm/w	
BG-267-2835-900	24V	20W	180 pcs/m	10mm	>90	1800 Lm	90 Lm/w	
BG-268-2835-1200	24/48V	20W	240 pcs/m	10mm	>90	1900 Lm	95 Lm/w	
BG-243-2835-1200	24V	24 W	240 pcs/m	12mm	>90	1920 Lm	86 Lm/w	
BG-245-2835-1200	24V	24 W	240 pcs/m	12mm	>90	1920 Lm	86 Lm/w	
BG-228-2835-500	12V	12W	100 pcs/m	8mm	>90	1032 Lm	86 Lm/w	
BG-229-2835-500	24V	12W	100 pcs/m	8mm	>90	1032 Lm	86 Lm/w	
BG-254-2835-600	12V	14.4 W	120 pcs/m	8mm	>90	1220 Lm	86 Lm/w	
BG-255-2835-600	24V	14.4 W	120 pcs/m	8mm	>90	1220 Lm	86 Lm/w	
BG-291-2835-600-RGB	24V	18 W	120 pcs/m	10mm	/	/	/	
BG-292-2835-600-RGB	24V	10 W	120 pcs/m	8mm	/	/	/	
BG-241-2835-600-SNA	24V	8 W	120 pcs/m	10mm	>90	840 Lm	100 Lm/w	
BG-311-2835-140-EC1	24V	14 W	140 pcs/m	8mm	>90	1260 Lm	90 Lm/w	
BG-311-2835-140-G2	24V	14 W	140 pcs/m	8mm	>80	1680 Lm	100 Lm/w	
BG-241-2835-600-SWM	24V	8 W	120 pcs/m	10mm	>90	840 Lm	100 Lm/w	
BG-240-2835-300-CAR	12V	5 W	60 pcs/m	8mm	>90	589 Lm	118 Lm/w	

SMD5050

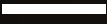



SMD5050 LED STRIP/5050软灯条

Dimensions: 5m/roll
 产品尺寸: 5米/卷
 Led type: SMD5050, high brightness led
 灯珠型号: SMD5050, 高亮LED
 PCB material: FPC double sides copper
 PCB材质: FPC双面铜
 Life Span: >36000hours
 产品寿命: >36000小时
 IP grade: IP20/IP65/IP66/IP68
 防水等级: IP20 / IP65 / IP66 / IP68

Application:

Interior design / 室内设计
 Architectural design / 建筑设计
 Advertisement project / 广告项目
 Outdoor illuminated signs / 户外照明标志
 Billboard decoration / 广告牌装饰
 Display design / 展示设计
 Underwater lighting engineering / 水下照明工程
 Car decoration / 汽车装饰

CCT Range/色温范围

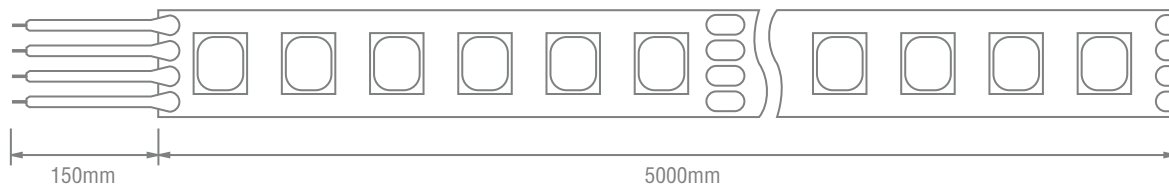
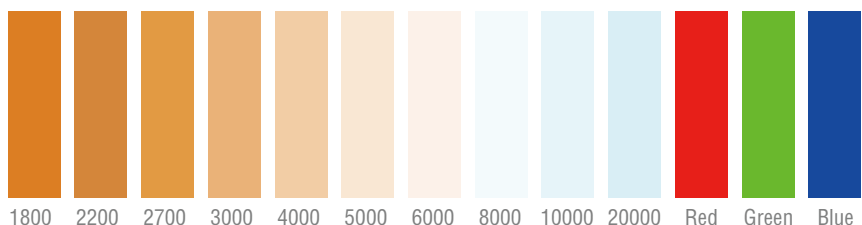

NO. 型号	VOLTAGE 电压(DC)	POWER 功率	LED QTY. 灯珠数量	PCB Width 板宽	CRI 显指	LUMEN FLUX 流明	Light Efficiency 光效	DIMENSIONS 剪切长度
BG-112-5050-150	12V/24V	7.2 W	30 pcs/m	10mm	>80	650 Lm	90 Lm/w	<div style="display: flex; justify-content: space-between; align-items: center;"> 24V 200mm </div>
BG-113-5050-300	12V/24V	14.4 W	60 pcs/m	10mm	>80	1300 Lm	90 Lm/w	<div style="display: flex; justify-content: space-between; align-items: center;"> 24V 100mm </div>
BG-278-5050-300-CCT	12V	12W	60 pcs/m	8mm	>80	1080 Lm	90 Lm/w	<div style="display: flex; justify-content: space-between; align-items: center;"> 12V 50mm </div>
BG-115-5050-300-CCT	12V/24V	14.4W	60 pcs/m	10mm	>80	1300 Lm	90 Lm/w	<div style="display: flex; justify-content: space-between; align-items: center;"> 24V 100mm </div>
BG-300-5050-300	24V	14.4W	60 pcs/m	10mm	/	/	/	<div style="display: flex; justify-content: space-between; align-items: center;"> 24V 17mm </div>
BG-119-5050-480	12V/24V	18 W	96 pcs/m	10mm	/	/	/	<div style="display: flex; justify-content: space-between; align-items: center;"> 24V 62.5mm </div>
BG-114-5050-600	12V/24V	24 W	120 pcs/m	15mm	>80	2160 Lm	90 Lm/w	<div style="display: flex; justify-content: space-between; align-items: center;"> 12V/24V 50mm </div>
BG-279-5050-600	12V/24V	18W	120 pcs/m	10mm	>80	/	/	<div style="display: flex; justify-content: space-between; align-items: center;"> 24V 50mm </div>

RGB(W/WW)



SMD3014



SMD3528



SMD2220

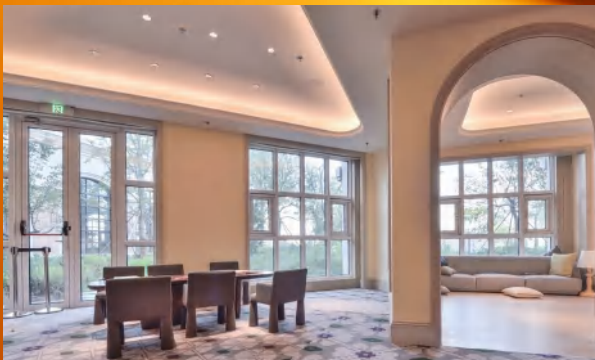
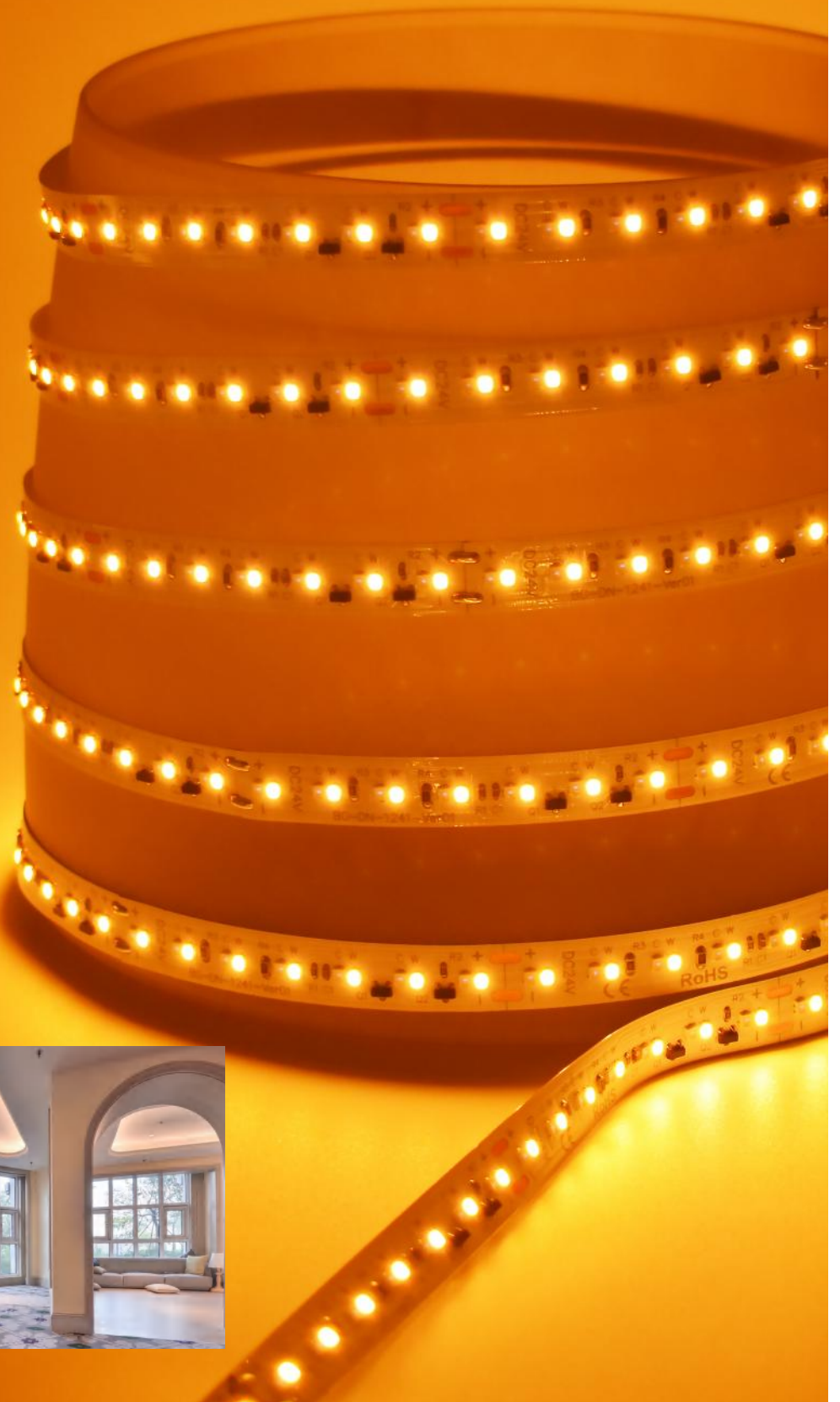

SMD2110



SMD3535

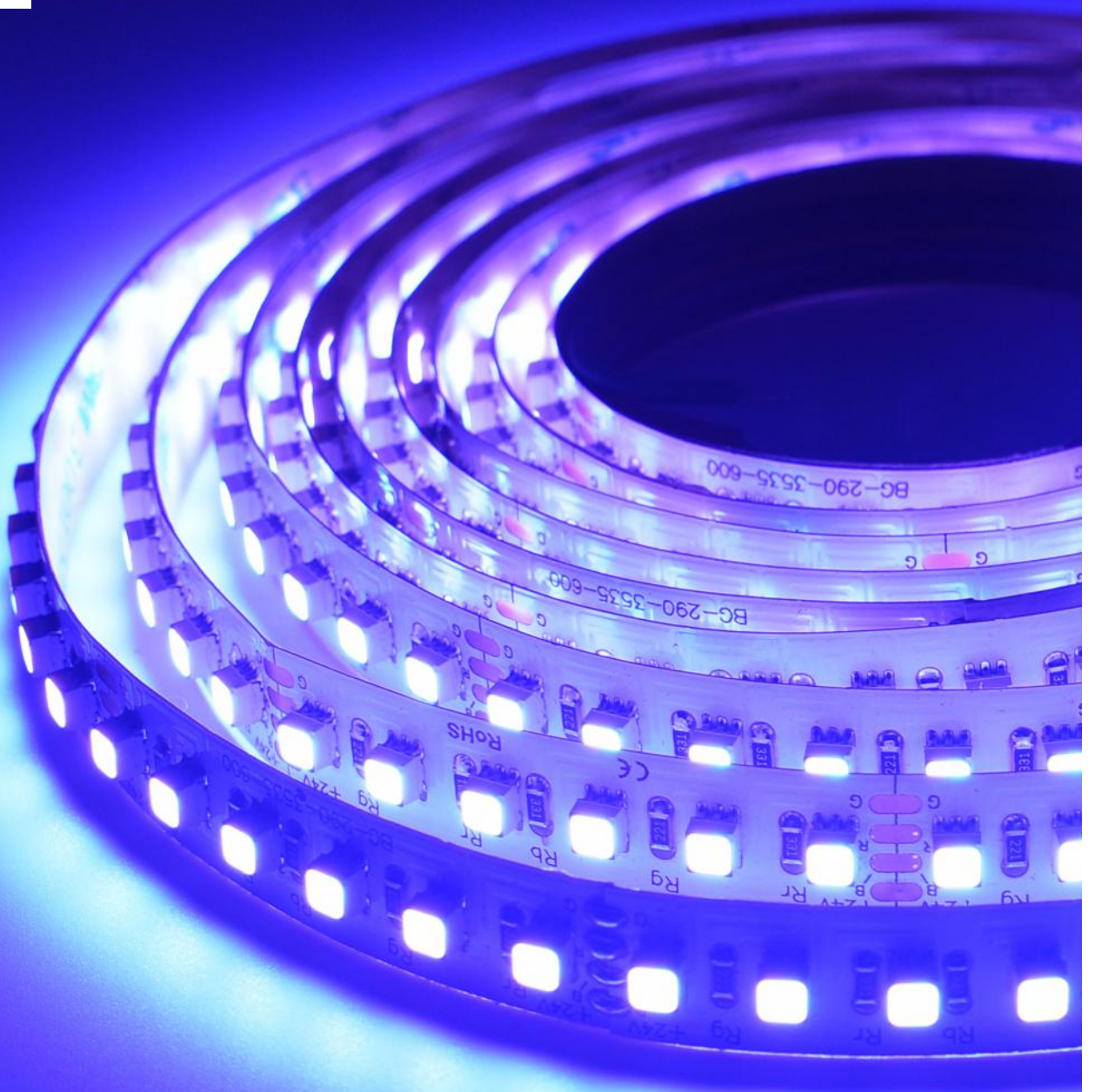

Addressable





Digital LED Strip/ 幻彩点控灯条

Addressable - 可寻址 -

PCB material: FPC double sides copper
 PCB材质: FPC 双面铜
 Life Span: >36000hours
 产品寿命: >36000小时
 IP grade: IP20/IP65/IP66/IP68
 防水等级: IP20 / IP65 / IP66 / IP68

Application:

- Interior design / 室内设计
- Architectural design / 建筑设计
- Advertisement project / 广告项目
- Outdoor illuminated signs / 户外照明标志
- Billboard decoration / 广告牌装饰
- Display design / 展示设计
- Underwater lighting engineering / 水下照明工程
- Car decoration / 汽车装饰

CCT Range/ 色温范围

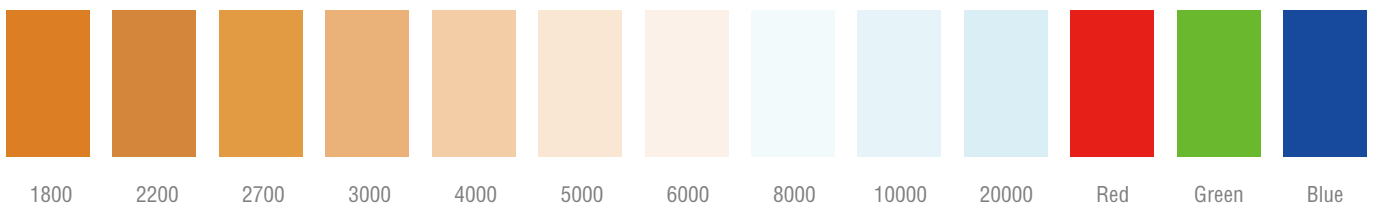

NO. 型号	VOLTAGE 电压 (DC)	POWER 功率	LED QTY. 灯珠数量	PCB Width 板宽	IC TYPE IC型号	Pixel Per Meter 每米像素	DIMENSIONS 剪切长度
BG-280-2835-600-IC White	24V	18 W	120 pcs/m	10mm	SM16703	20 Pixels	24V 50mm
BG-210B-5050-150-IC	12V	7.2 W	30 pcs/m	10mm	WS2811	10 Pixels	12V 100mm
BG-210B-5050-210-IC	12V	9.6 W	42 pcs/m	12mm	WS2811	14 Pixels	12V 71.4mm
BG-285B-5050-300-IC	12V	12 W	60 pcs/m	12mm	WS2811	20 Pixels	12V 50mm
BG-235B-5050-300-IC	24V	12 W	60 pcs/m	12mm	WS2811	10 Pixels	24V 100mm
BG-289-2835-600-IC	24V	24 W	120 pcs/m	8mm	WS2811	20 Pixels	24V 50mm
BG-230C-5050-150-IC	5V	6 W	30 pcs/m	10mm	BG6812	30 Pixels	5V 33.3mm
BG-230B-5050-150-IC	12V	3.6 W	30 pcs/m	10mm	BG6811	30 Pixels	12V 33.3mm
BG-231C-5050-300-IC	5V	12 W	60 pcs/m	12mm	BG6812	60 Pixels	5V 16.7mm
BG-231B-5050-300-IC	12V	7.2 W	60 pcs/m	12mm	BG6811	60 Pixels	12V 16.7mm
BG-232B-5050-150-IC	12V	3.6 W	30 pcs/m	10mm	BG6815	30 Pixels	12V 33.3mm
BG-233B-5050-300-IC	12V	7.2 W	60 pcs/m	10mm	BG6815	60 Pixels	12V 16.7mm
BG-234A-5050-300-IC RGBW	12V	16.8 W	60 pcs/m	12mm	WS2814	20 Pixels	12V 50mm
BG-234B-5050-300-IC RGBW	12V	16.8 W	60 pcs/m	12mm	UCS2904	20 Pixels	12V 50mm
BG-236A-5050-300-IC RGBW	24V	16.8 W	60 pcs/m	12mm	WS2814	10 Pixels	24V 100mm
BG-236B-5050-300-IC RGBW	24V	16.8 W	60 pcs/m	12mm	UCS2904	10 Pixels	24V 100mm
BG-307-5050-300-IC RGB+CCT	24V	23 W	60 pcs/m	10mm	FW1808	10 Pixels	24V 100mm
BG-308-1515-100-IC	5V	8 W	100 pcs/m	4mm	FW1808	100 Pixels	5V 10mm

DMX512



DMX512 LED Strip/DMX512 灯条



DMX512 standard protocol
- DMX512 标准协议 -

PCB material: FPC double sides copper
 PCB 材质: FPC 双面铜
 Life Span: >36000hours
 产品寿命: >36000 小时
 IP grade: IP20/IP65/IP66/IP68
 防水等级: IP20 / IP65 / IP66 / IP68

Application:

- Interior design / 室内设计
- Architectural design / 建筑设计
- Advertisement project / 广告项目
- Outdoor illuminated signs / 户外照明标志
- Billboard decoration / 广告牌装饰
- Display design / 展示设计
- Underwater lighting engineering / 水下照明工程
- Car decoration / 汽车装饰

CCT Range/色温范围

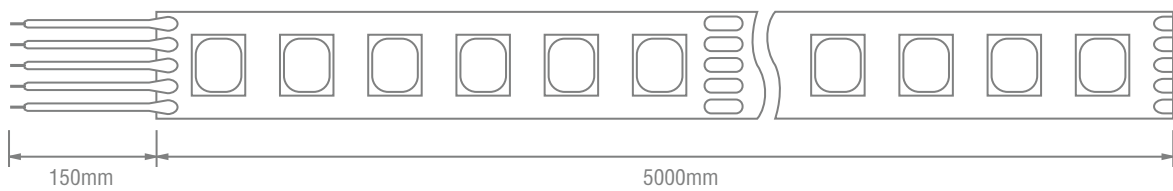
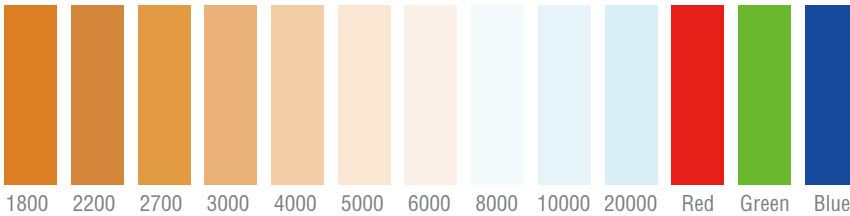

NO. 型号	VOLTAGE 电压(DC)	POWER 功率	LED QTY. 灯珠数量	PCB Width 板宽	IC TYPE IC 型号	Pixel Per Meter 每米像素	DIMENSIONS 剪切长度
BG-286-2835-350-DMX White	24V	17 W	70 pcs/m	10mm	UCS512	10 Pixels	24V 100mm
BG-288-5050-280-DMX CCT	24V	14 W	56 pcs/m	12mm	UCS512	8 Pixels	24V 100mm
BG-238-5050-300-DMX RGB	24V	13 W	60 pcs/m	12mm	UCS512	10 Pixels	24V 100mm
BG-239-5050-300-DMX RGBW	24V	17W	60 pcs/m	12mm	UCS512	10 Pixels	24V 100mm
BG-237-5050-300-DMX RGBW	24V	17W	60 pcs/m	12mm	UCS512	10 Pixels	24V 100mm

Constant Current



Narrow



Narrow LED Strip/超窄灯条

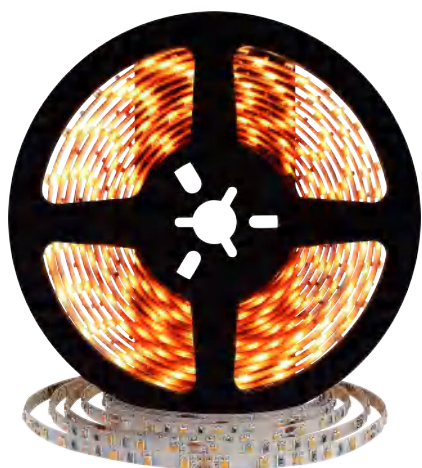

PCB Width: 3mm

— 最窄板宽3mm —

PCB material: FPC double sides copper

PCB材质: FPC双面铜

Life Span: >36000hours

产品寿命: >36000小时

IP grade: IP20/IP65/IP66/IP68

防水等级: IP20 / IP65 / IP66 / IP68

Application:

Interior design / 室内设计

Architectural design / 建筑设计

Advertisement project / 广告项目

Outdoor illuminated signs / 户外照明标志

Billboard decoration / 广告牌装饰

Display design / 展示设计

Underwater lighting engineering / 水下照明工程

Car decoration / 汽车装饰

CCT Range/色温范围

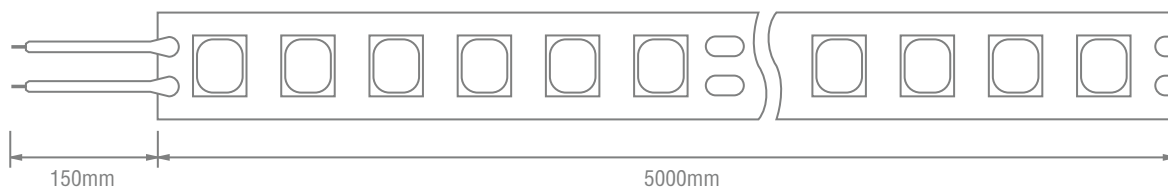
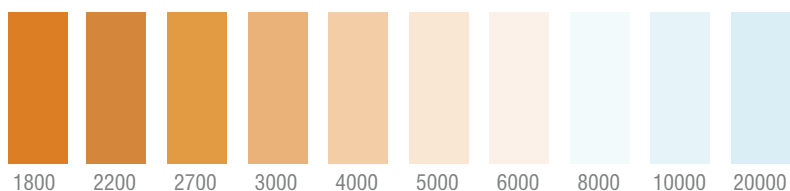

NO. 型号	VOLTAGE 电压(DC)	POWER 功率	LED QTY. 灯珠数量	PCB Width 板宽	CRI 显指	LUMEN FLUX 流明	Light Efficiency 光效	DIMENSIONS 剪切长度
BG-259-2835-600	12V/24V	6 W	120 pcs/m	3mm	>90	600 Lm	100 Lm/w	
BG-262-2220-600	24V	6 W	120 pcs/m	4mm	>90	600 Lm	100 Lm/w	
BG-264-2220-1200	24V	7.2 W	240 pcs/m	4mm	>90	720 Lm	100 Lm/w	
BG-284-2110-1200	24V	7.2 W	240 pcs/m	4mm	>90	720 Lm	100 Lm/w	
BG-120-3528-300	12V/24V	4.8 W	60 pcs/m	5mm	>80	960 Lm	100 Lm/w	
BG-121-3528-600	12V/24V	9.6 W	120 pcs/m	5mm	>80	960 Lm	100 Lm/w	
BG-252-3014-600	12V/24V	9.6 W	120 pcs/m	5mm	>80	960 Lm	100 Lm/w	
BG-258-2835-600	12V	9.6 W	120 pcs/m	5mm	>90	960 Lm	100 Lm/w	

High Voltage

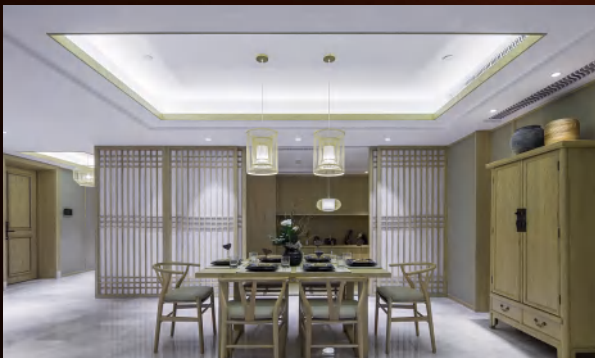
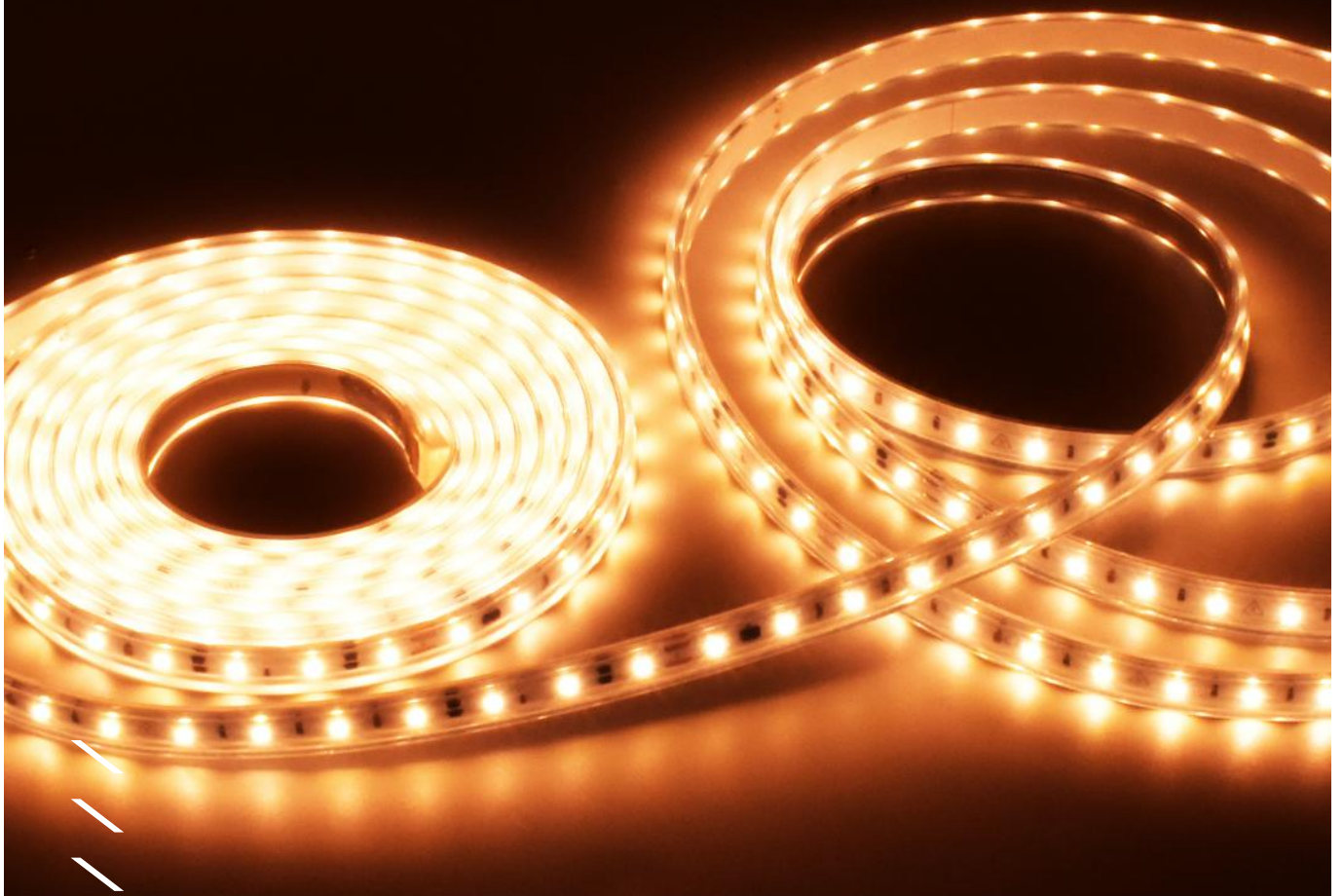

High Voltage LED Strip/高压灯条



Voltage/电压
- AC110V/230V -

PCB material: FPC double sides copper

PCB材质: FPC双面铜

Life Span: >36000hours

产品寿命: >36000小时

IP grade: IP66/IP68

防水等级: IP66 / IP68

Application:

Interior design / 室内设计

Architectural design / 建筑设计

Advertisement project / 广告项目

Outdoor illuminated signs / 户外照明标志

Billboard decoration / 广告牌装饰

Display design / 展示设计

Underwater lighting engineering / 水下照明工程

Car decoration / 汽车装饰

CCT Range/色温范围

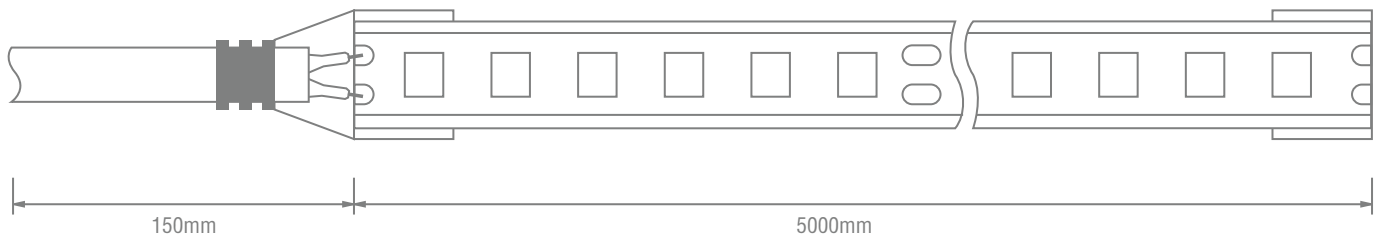
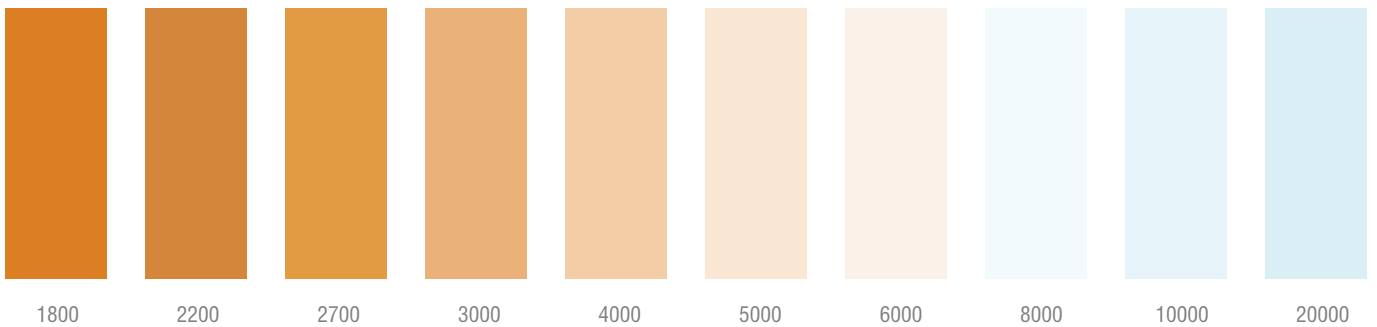

NO. 型号	VOLTAGE 电压(AC)	POWER 功率	LED QTY. 灯珠数量	PCB Width 板宽	CRI 显指	LUMEN FLUX 流明	Light Efficiency 光效	DIMENSIONS 剪切长度
BG-400-2835-300	230V	10 W	60 pcs/m	10mm	>80	910 Lm	90 Lm/w	AC230V 200mm
BG-401-2835-600	230V	18 W	120 pcs/m	10mm	>80	1620 Lm	90 Lm/w	AC230V 100mm
BG-401-2835-600-S	230V	18 W	120 pcs/m	10mm	>80	2350 Lm	130 Lm/w	AC230V 100mm

UVA/C



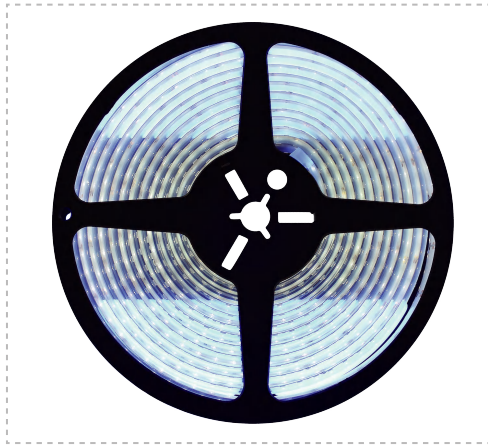

UV LED STRIP/UV软灯条

Dimensions: 5m/roll

产品尺寸: 5米/卷

PCB material: FPC double sides copper

PCB材质: FPC双面铜

IP grade: IP20

防水等级: IP20

Application:

Welding

固化

Disinfection

消毒杀菌

Anti-counterfeiting verification

防伪验证



Health
健康



Environmental Protection
环保



Sterilization
杀菌



Energy Saving
节能



Convenient
便携

NO. 型号	VOLTAGE 电压 (DC)	POWER 功率	LED QTY. 灯珠数量	PCB Width 板宽	Wave Length 波长	DIMENSIONS 剪切长度
SMD2835 UVA LED Strip						
BG-240-2835-300	12V/24V	10 W	60 pcs/m	8mm	365-375nm 380-390nm	
BG-241-2835-600	12V/24V	15 W	120 pcs/m	10mm	390-400nm 400-410nm	

NO. 型号	LED TYPE 灯珠型号	VOLTAGE 电压 (DC)	POWER 功率	Padiant Power 辐射功率	LED QTY. 灯珠数量	PCB Width 板宽	Wave Length 波长	DIMENSIONS 剪切长度
SMD3535 UVC LED Strip								
BG-302-3535-120-UVC-A	3535+2835	12V	6 W	30 mW	UVC 12 pcs UVA 12 pcs	8mm	UVC 270-280 NM UVA 395-405 NM	
BG-304-3535-150-UVC-A	3535	12V	10 W	160 mW	UVC 30 pcs (2 in 1)	8mm	UVC 270-280 NM UVA 395-405 NM	
SMD3535 UVC LED Bar Light								
BG-1732C-3535-12-A	3535	12V	6 W	30 mW	UVC 12 pcs (2 in 1)	12mm	UVC: 270-280 NM UVA: 395-405 NM	
BG-1732A-3535-12-A	3535	24V	6 W	30 mW	UVC 12 pcs	12mm	270-280 NM	
BG-1732B-3535-12-A	3535	24V	10W	80 mW	UVC 12 pcs	12mm	270-280 NM	
UVC Sterilize Lamp								
BG-DN-3535-UVC-20W-A	3535+2835	24V	20W	120 mW	UVC 18 pcs UVA 18 pcs	29mm	270-280 NM 395-405 NM	500x35x14mm

Kit





Kit LED Strip/套装灯条

Box/盒子
DC connector/连接器
5m led strip/5米灯带
Power supply/电源

PCB material: FPC double sides copper
 PCB材质: FPC 双面铜
 Life Span: >36000hours
 产品寿命: >36000小时
 IP grade: IP20/IP65/IP66/IP68
 防水等级: IP20 / IP65 / IP66 / IP68

Application:

- Interior design / 室内设计
- Architectural design / 建筑设计
- Advertisement project / 广告项目
- Outdoor illuminated signs / 户外照明标志
- Billboard decoration / 广告牌装饰
- Display design / 展示设计
- Car decoration / 汽车装饰

Connection Diagram/连接图

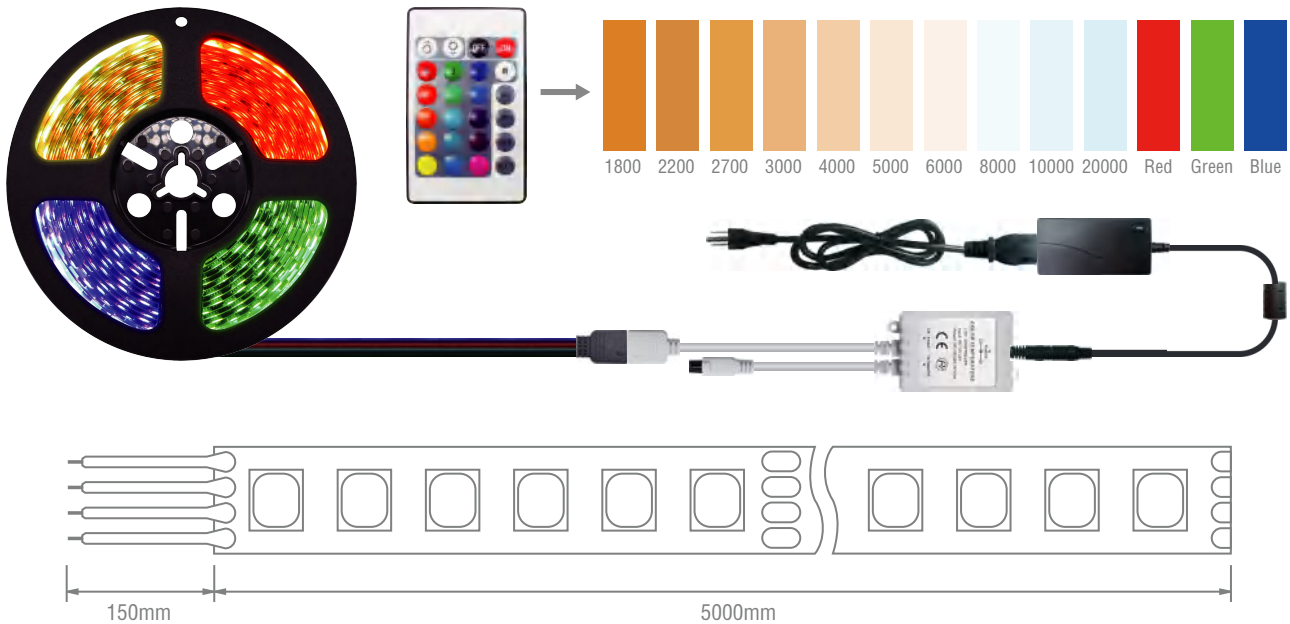

NO. 型号	VOLTAGE 电压 (DC)	POWER 功率	LED QTY. 灯珠数量	PCB Width 板宽	CRI 显指	DIMENSIONS 剪切长度
BG-240-2835-300-K	12V/24V	14.4 W	60 pcs/m	10mm	>80	
BG-112-5050-150-K	12V/24V	7.2 W	30 pcs/m	10mm	>80	
BG-113-5050-300-K	12V/24V	14.4 W	60 pcs/m	10mm	>80	
BG-112-5050-150-RGB-K	12V/24V	7.2 W	30 pcs/m	10mm	/	
BG-113-5050-300-RGB-K	12V/24V	14.4 W	60 pcs/m	10mm	/	
BG-213-5050-300-RGB+W-K	24V	14.4 W	60 pcs/m	10mm	/	
BG-216-5050-150-RGBW-K	24V	8 W	30 pcs/m	12mm	/	
BG-214-5050-300-RGBW-K	12V/24V	16 W	60 pcs/m	12mm	/	

FCOB LED STRIP

Roll To Roll

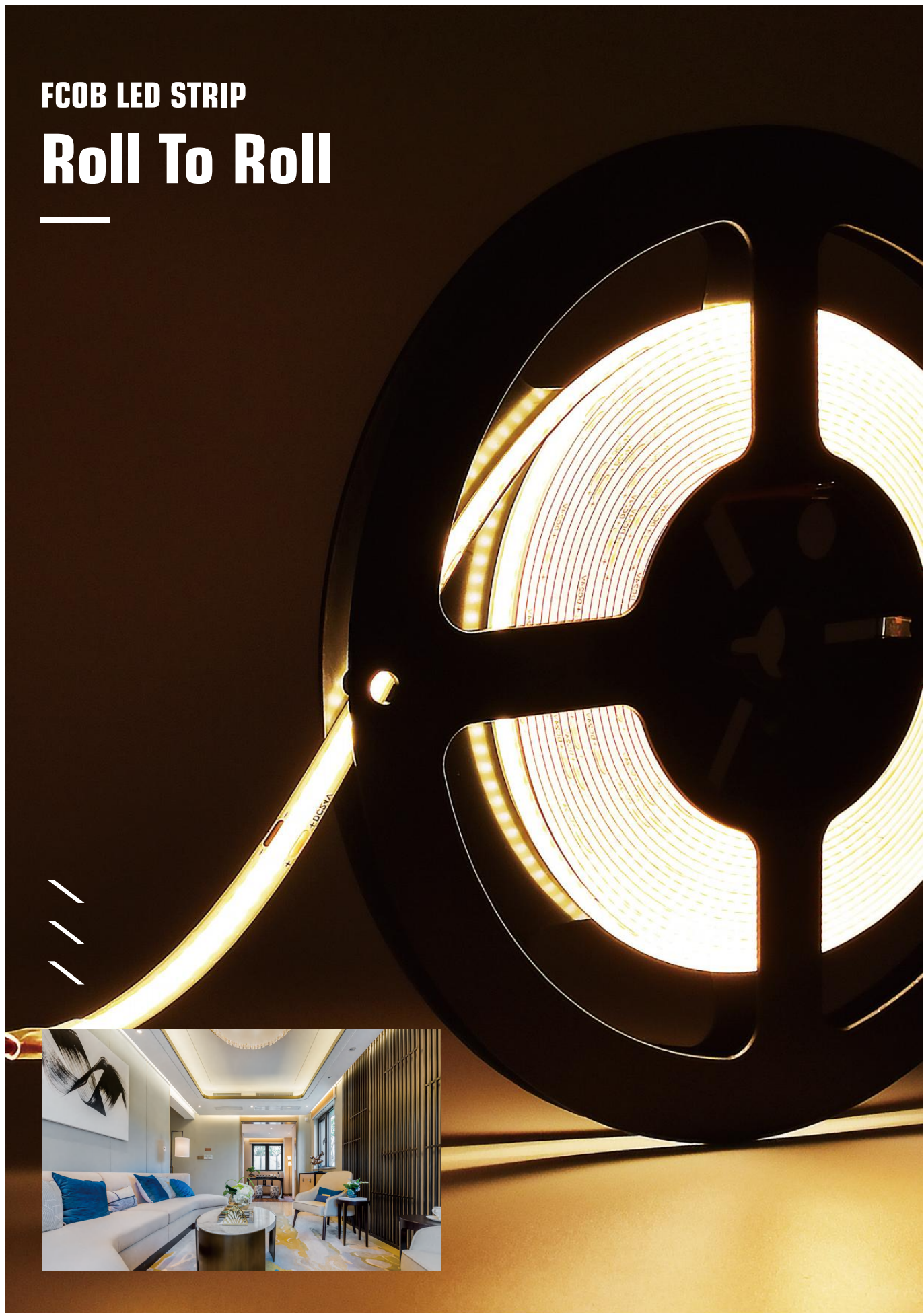

FCOB LED STRIP

Narrow



FCOB LED STRIP

Single Color



FCOB LED STRIP

Tunable White



CCT COB Strip/双色COB灯条

Tunable White series

- 白光可调系列 -

Application:

Interior design / 室内设计

Architectural design / 建筑设计

Advertisement project / 广告项目

Outdoor illuminated signs / 户外照明标志

Billboard decoration / 广告牌装饰

Display design / 展示设计

PCB material: FPC double sides copper

PCB材质: FPC双面铜

Life Span: >36000hours

产品寿命: >36000小时

IP grade: IP20/IP65/IP66/IP68

防水等级: IP20 / IP65 / IP66 / IP68

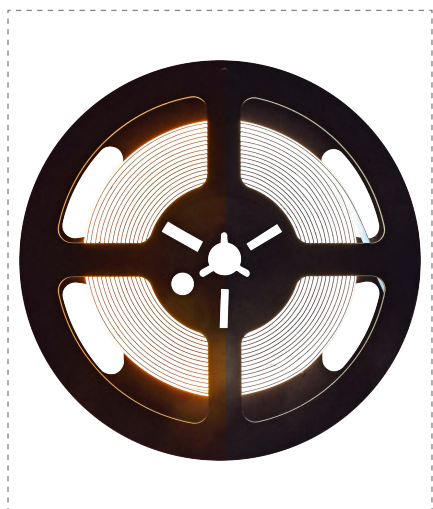

CCT Range/色温范围

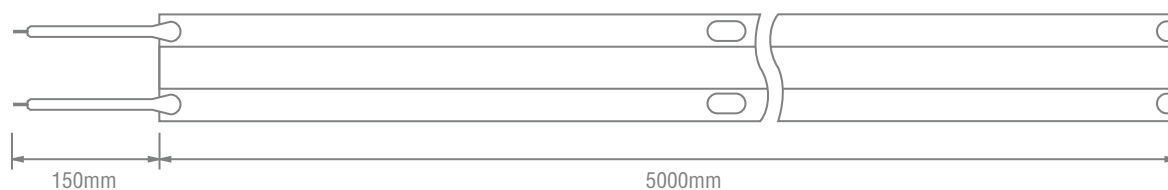
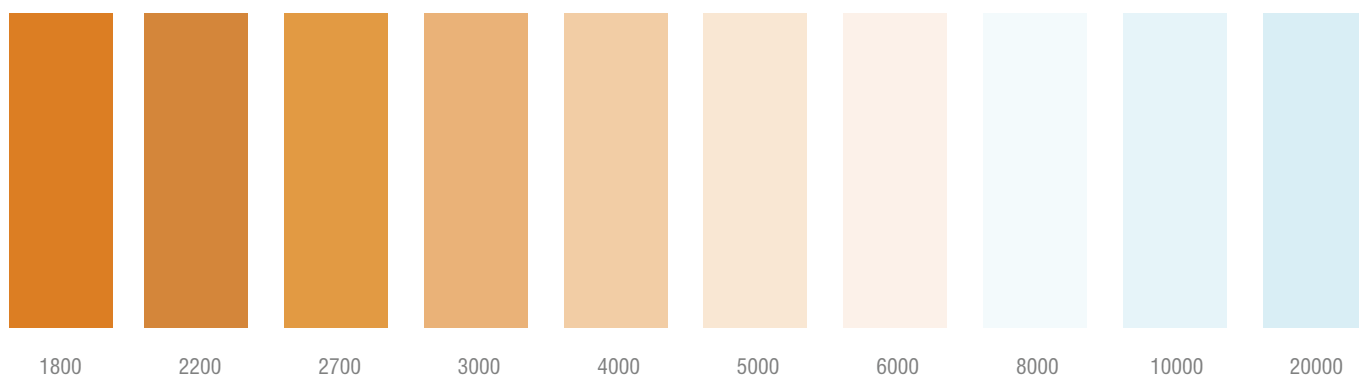

NO. 型号	VOLTAGE 电压(DC)	POWER 功率	Chip QTY. 灯数	PCB Width 板宽	CRI 显指	LUMEN FLUX 流明	Efficiency 光效	DIMENSIONS 剪切长度
BG-3050-600-A	24V	14 W	600 Chip/m	5 mm	>90	1190 Lm/m	85 Lm/w	24V 20mm
BG-3051-512-A	24V	18 W	512 Chip/m	8 mm	>90	2160 Lm/m	120 Lm/w	24V 31.3mm
BG-3052-608-A	12V/24V	22 W	608 Chip/m	10 mm	>90	2640 Lm/m	120 Lm/w	24V 26.3mm 12V 13.2mm
BG-3025-640-A	24V	22 W	640 Chip/m	10 mm	>90	2640 Lm/m	120 Lm/w	24V 50mm

FCOB LED STRIP

RGB(W/WW)



RGB COB Strip/RGB COB灯条

RGB/RGBW/RGBWW

- RGB系列 -

PCB material: FPC double sides copper

PCB材质: FPC双面铜

Life Span: >36000hours

产品寿命: >36000小时

IP grade: IP20/IP65/IP66/IP68

防水等级: IP20 / IP65 / IP66 / IP68

Application:

Interior design / 室内设计

Architectural design / 建筑设计

Advertisement project / 广告项目

Outdoor illuminated signs / 户外照明标志

Billboard decoration / 广告牌装饰

Display design / 展示设计

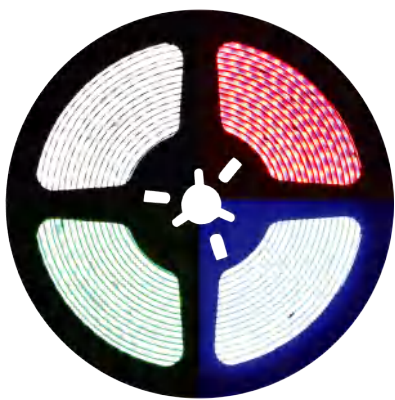

CCT Range/色温范围

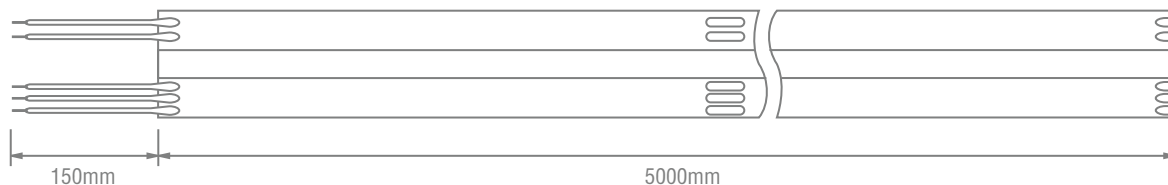
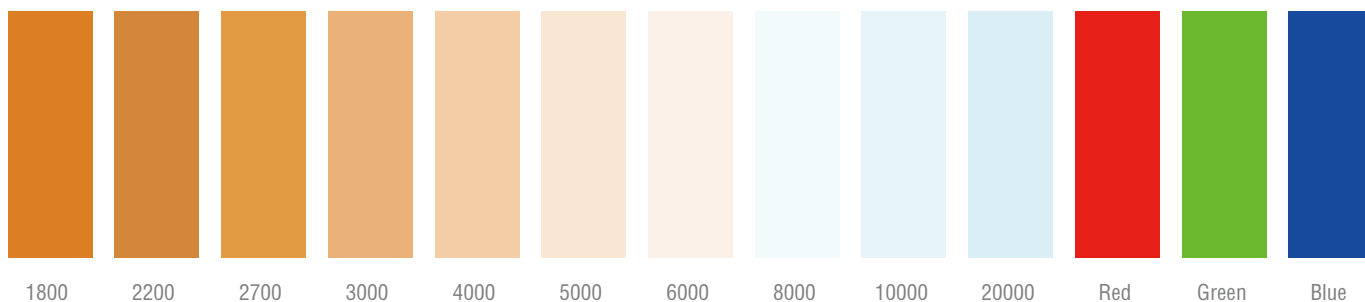

NO. 型号	VOLTAGE 电压(DC)	POWER 功率	Chip QTY. 灯数	PCB Width 板宽	CRI 显指	DIMENSIONS 剪切长度
BG-3061-450	12V	15 W	450 Chip/m	10 mm	/	12V 20mm
BG-3062-480	24V	15 W	480 Chip/m	10 mm	/	24V 50mm
BG-3026-810	12V	20 W	810 Chip/m	10 mm	/	12V 11mm
BG-3027-840	24V	25 W	840 Chip/m	10 mm	/	24V 25mm
BG-3029-816 RGBW	12V	16 W	816 Chip/m	12 mm	>90	12V 29.4mm
BG-3029-896-A RGBW	24V	16 W	896 Chip/m	12 mm	>90	24V 31.3mm
BG-3028-840-A RGB CCT	24V	16 W	840 Chip/m	12 mm	>90	24V 41.6mm

FCOB LED STRIP

Constant Current

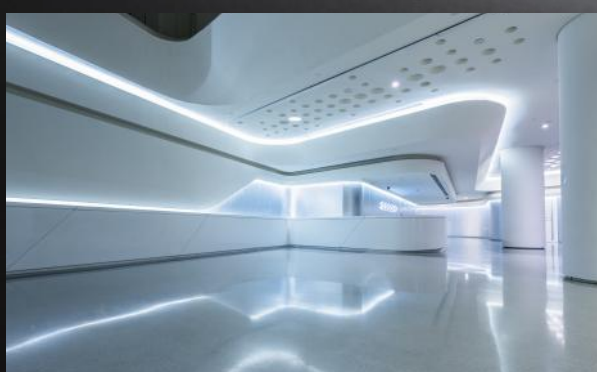
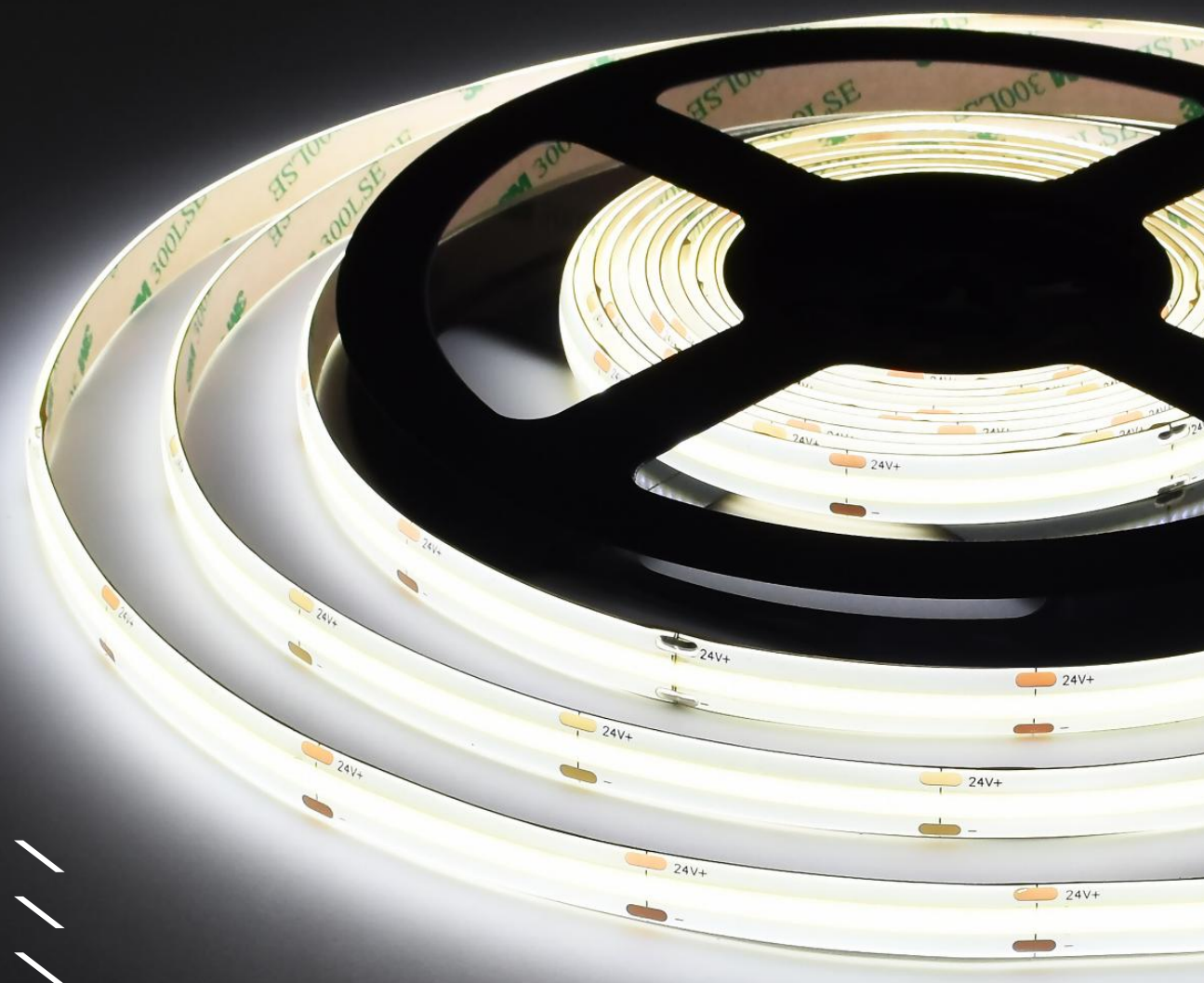

FCOB LED STRIP

Mini Cutting

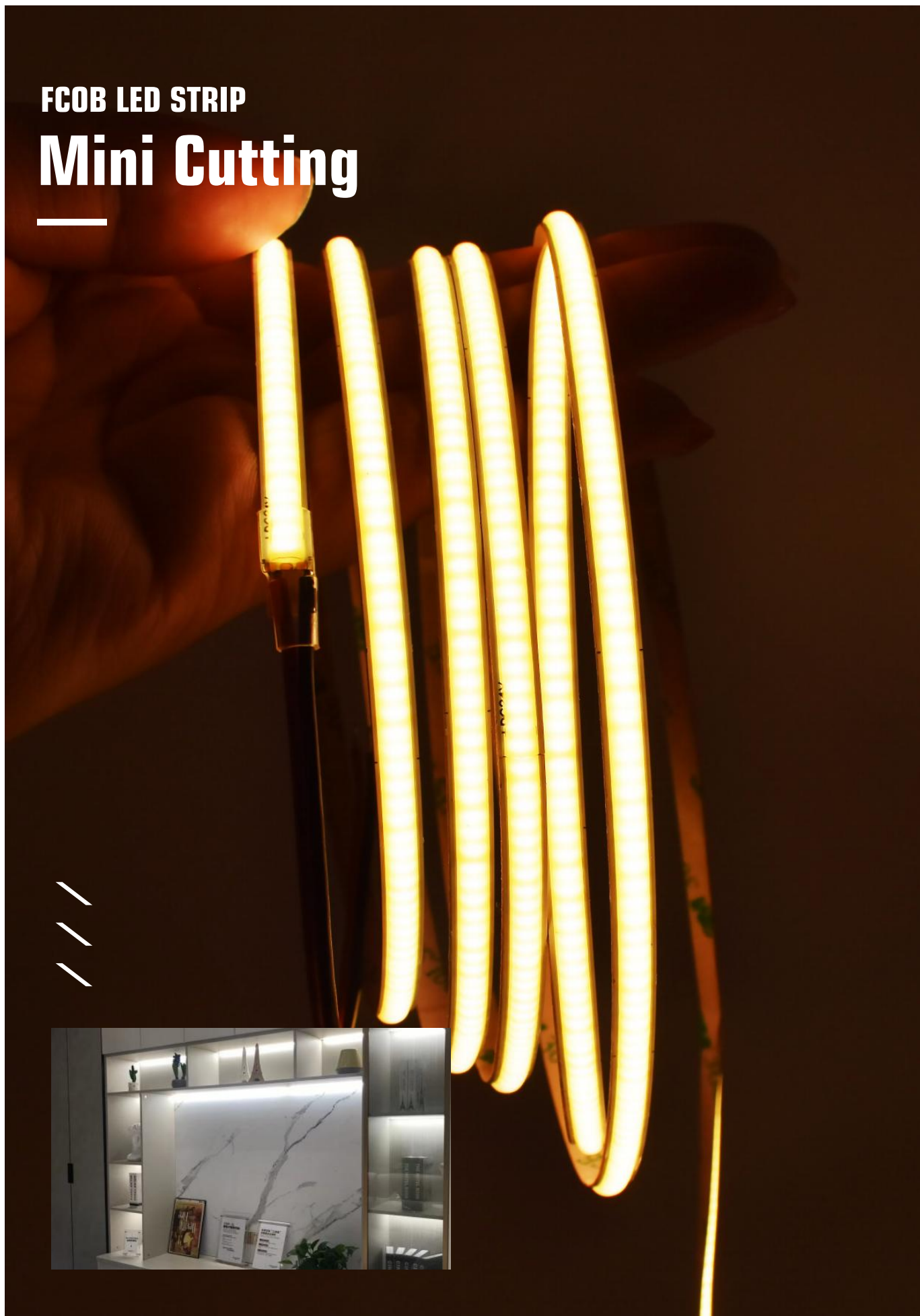

FCOB LED STRIP

Free Cutting

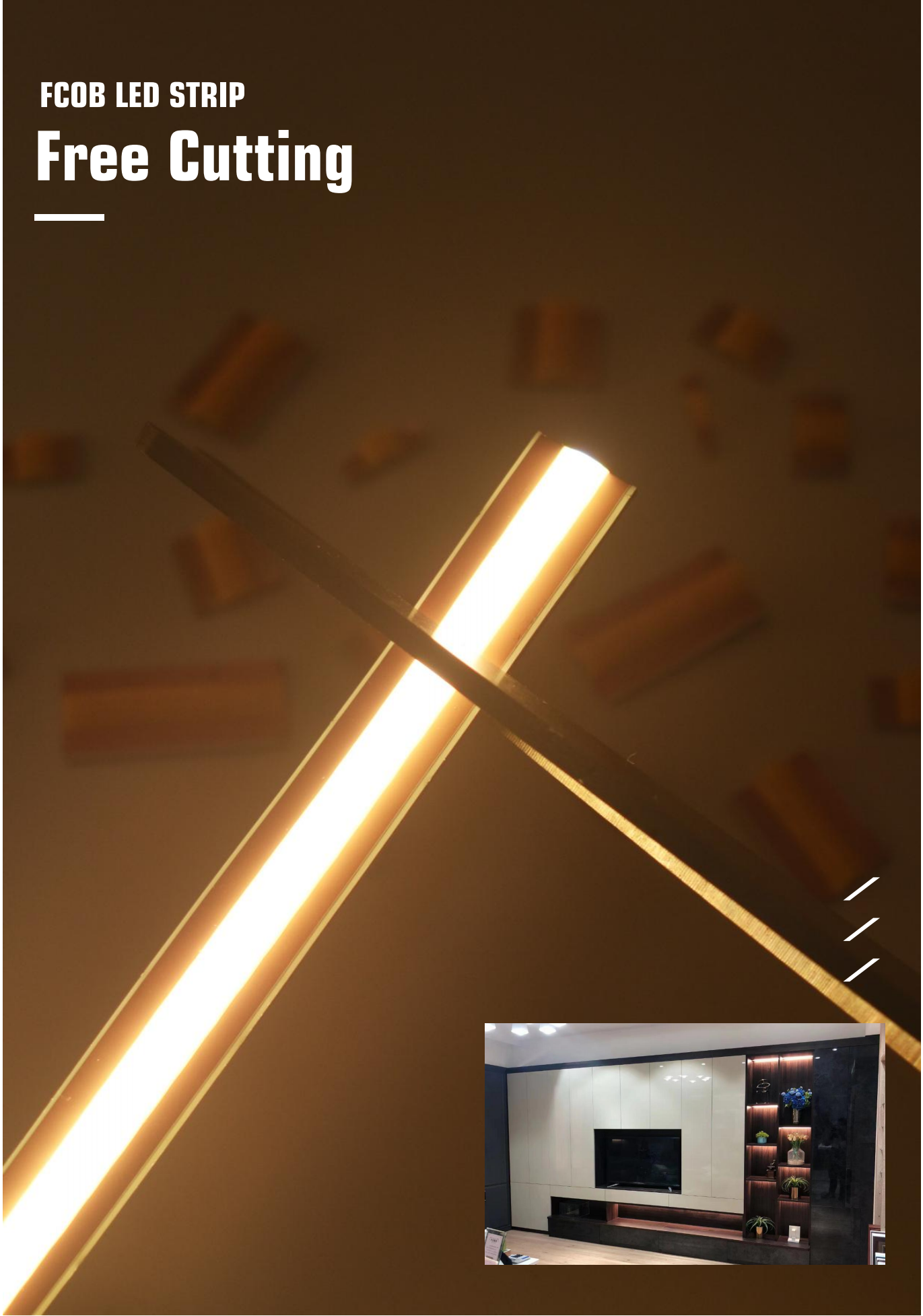

FCOB LED STRIP

Addressable



Digital COB Strip/幻彩COB灯条

Addressable

- 可寻址 -

PCB material: FPC double sides copper

PCB 材质: FPC 双面铜

Life Span: >36000hours

产品寿命: >36000 小时

IP grade: IP20/IP65/IP66/IP68

防水等级: IP20 / IP65 / IP66 / IP68

Application:

Interior design / 室内设计

Architectural design / 建筑设计

Advertisement project / 广告项目

Outdoor illuminated signs / 户外照明标志

Billboard decoration / 广告牌装饰

Display design / 展示设计



CCT Range/色温范围

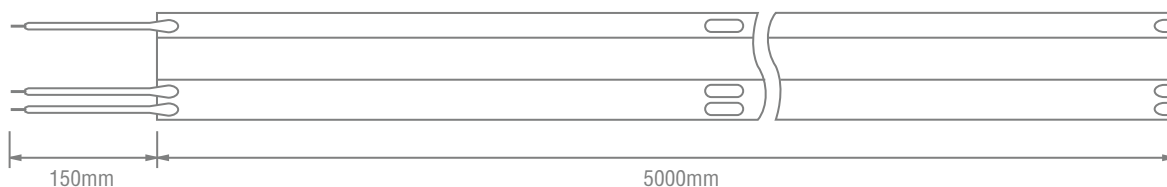
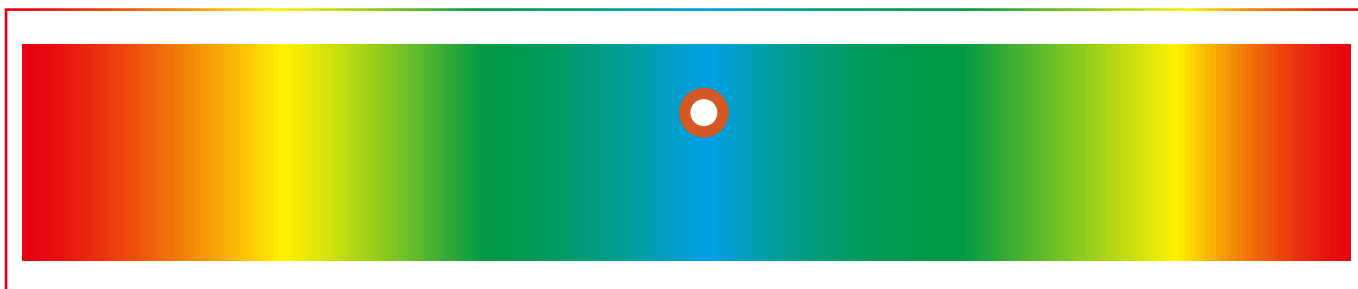

NO. 型号	VOLTAGE 电压 (DC)	POWER 功率	Chip QTY. 灯数	PCB Width 板宽	Pixels Per Meter 像素	DIMENSIONS 剪切长度
BG-3092-420-B White	24V	10 W	420 Chip/m	10 mm	10 Pixels	24V 100mm
BG-3094-560 CCT	24V	9 W	560 Chip/m	10 mm	10 Pixels	24V 100mm
BG-3091-432 RGB	12V	7 W	432 Chip/m	10 mm	10 Pixels	12V 100mm
BG-3091-420 RGB	24V	15 W	420 Chip/m	10 mm	10 Pixels	24V 100mm
BG-3095-576 RGB	12V/24V	13 W	576 Chip/m	10 mm	10 Pixels	12V/24V 100mm
BG-3093-840 RGBW	24V	16 W	840 Chip/m	12 mm	10 Pixels	24V 100mm

FCOB LED STRIP
Side View

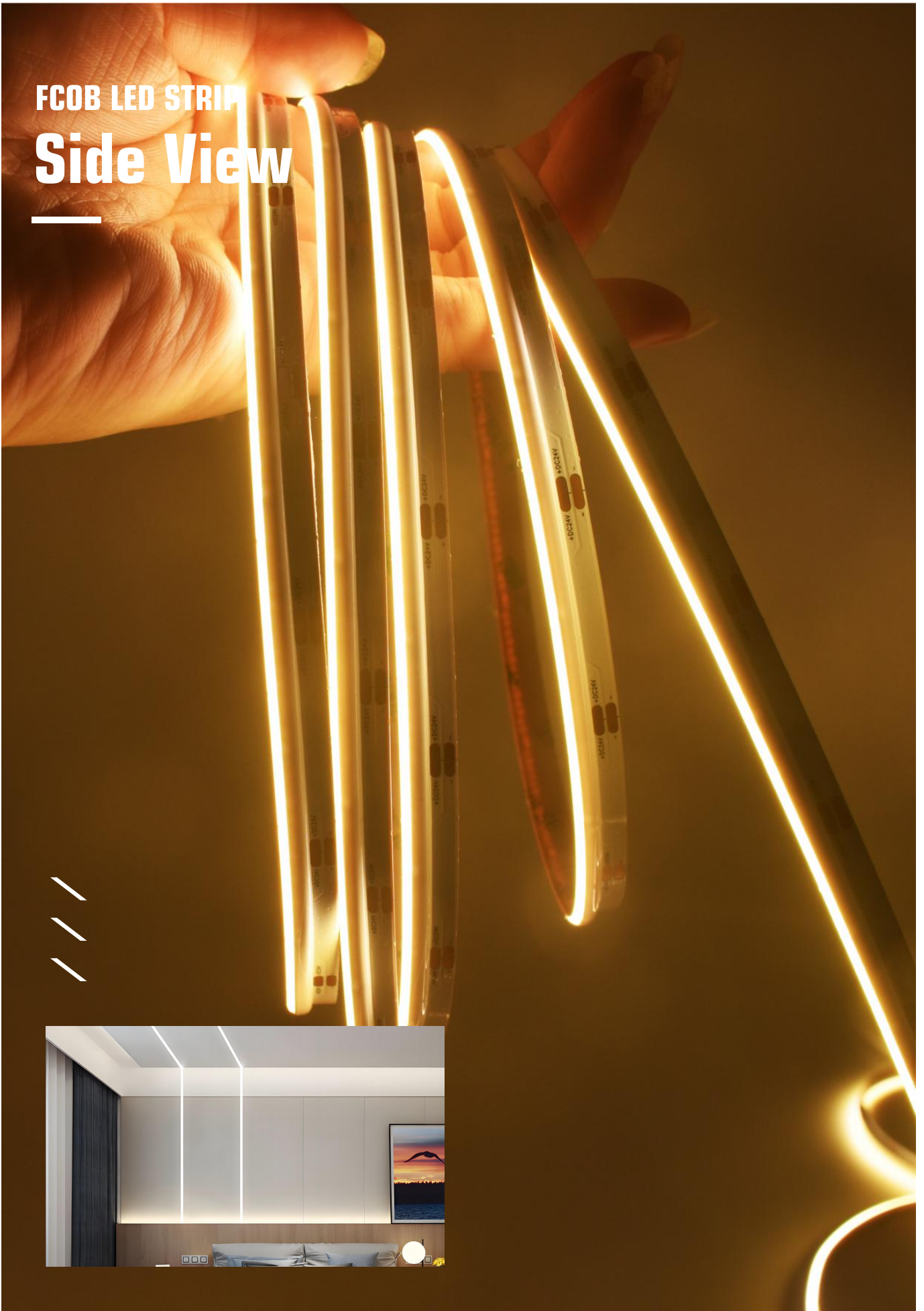

COB Strip/COB 灯条

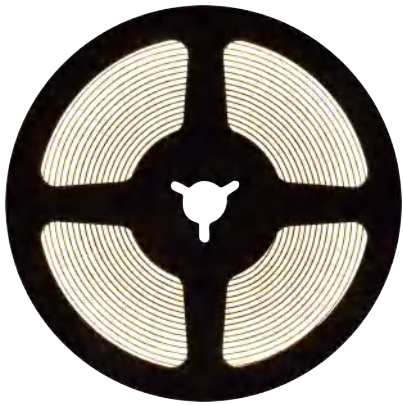

Side View Series - 侧发光系列 -

PCB material: FPC double sides copper

PCB 材质: FPC 双面铜

Life Span: >36000hours

产品寿命: >36000 小时

Application:

Interior design / 室内设计

Architectural design / 建筑设计

Advertisement project / 广告项目

Outdoor illuminated signs / 户外照明标志

Billboard decoration / 广告牌装饰

Display design / 展示设计

CCT Standard/标准色温

2700

3000

4000

6000

CCT Range/色温范围

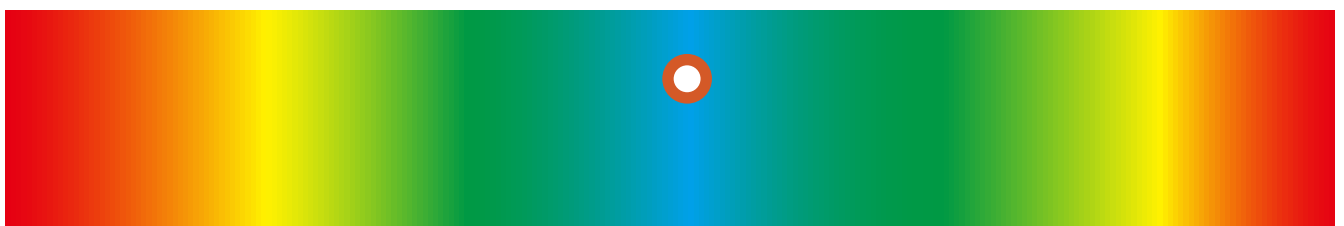

NO. 型号	VOLTAGE 电压 (DC)	POWER 功率	Chip QTY. 灯数	PCB Width 板宽	CRI 显指	LUMEN FLUX 流明	Efficiency 光效	DIMENSIONS 剪切长度
BG-3101-420 White	24V	10 W	420 Chip/m	8 mm	>90	600 Lm/m	60 Lm/w	24V 33.3mm
BG-3102-630 RGB	24V	9 W	630 Chip/m	10 mm	/	/	/	24V 100mm

NO. 型号	VOLTAGE 电压 (DC)	POWER 功率	Chip QTY. 灯数	PCB Width 板宽	Pixels Per Meter 像素	DIMENSIONS 剪切长度
BG-3104-630 RGB	24V	11 W	630 Chip/m	10 mm	10 Pixels	24V 100mm

FCOB LED STRIP

High Voltage



LED NEON LIGHT

Side View

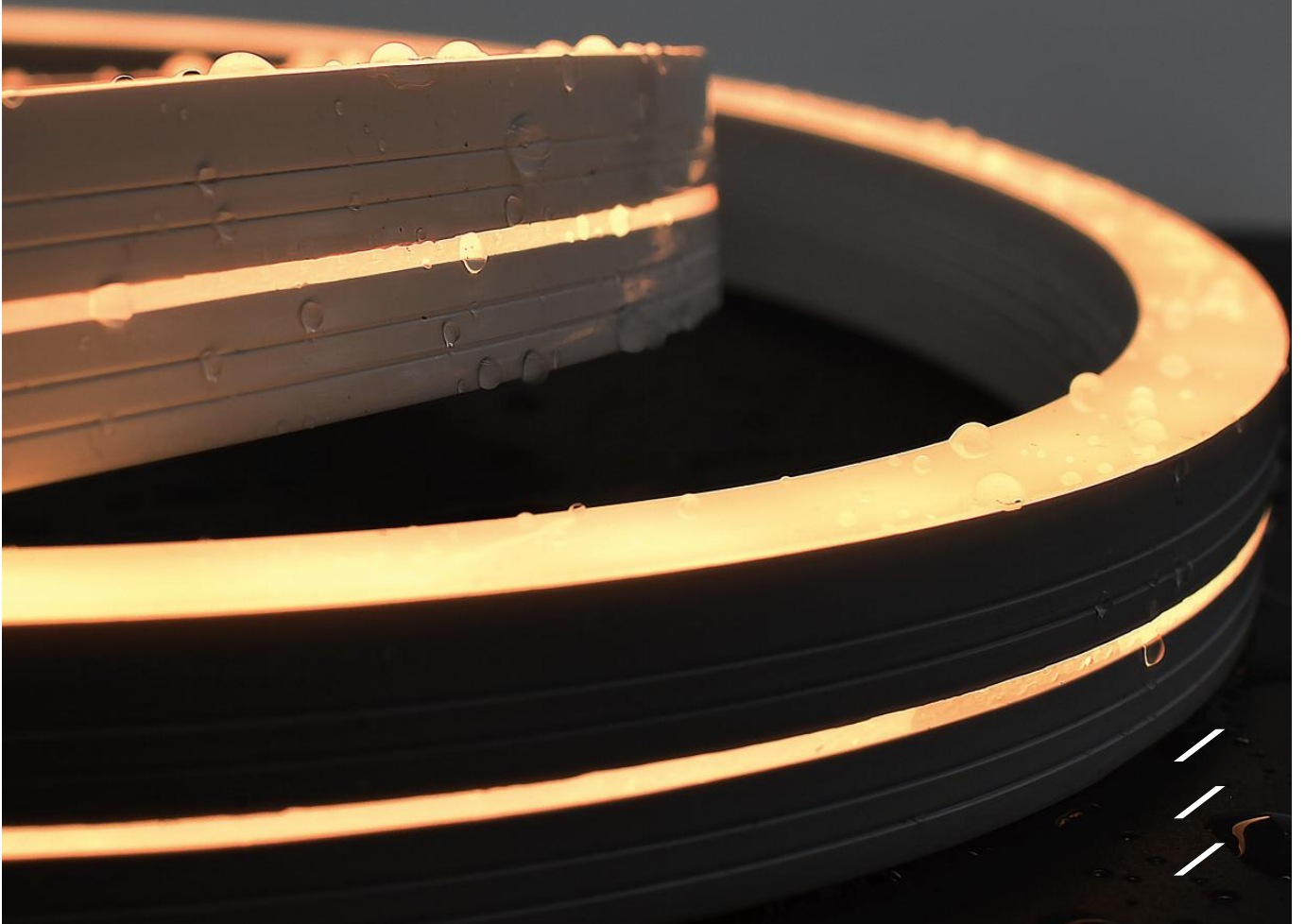

LED NEON LIGHT

Top View



LED NEON LIGHT

Round View



LED NEON LIGHT

Free Style



LED NEON LIGHT

Super Long



LED NEON LIGHT

Mini Size

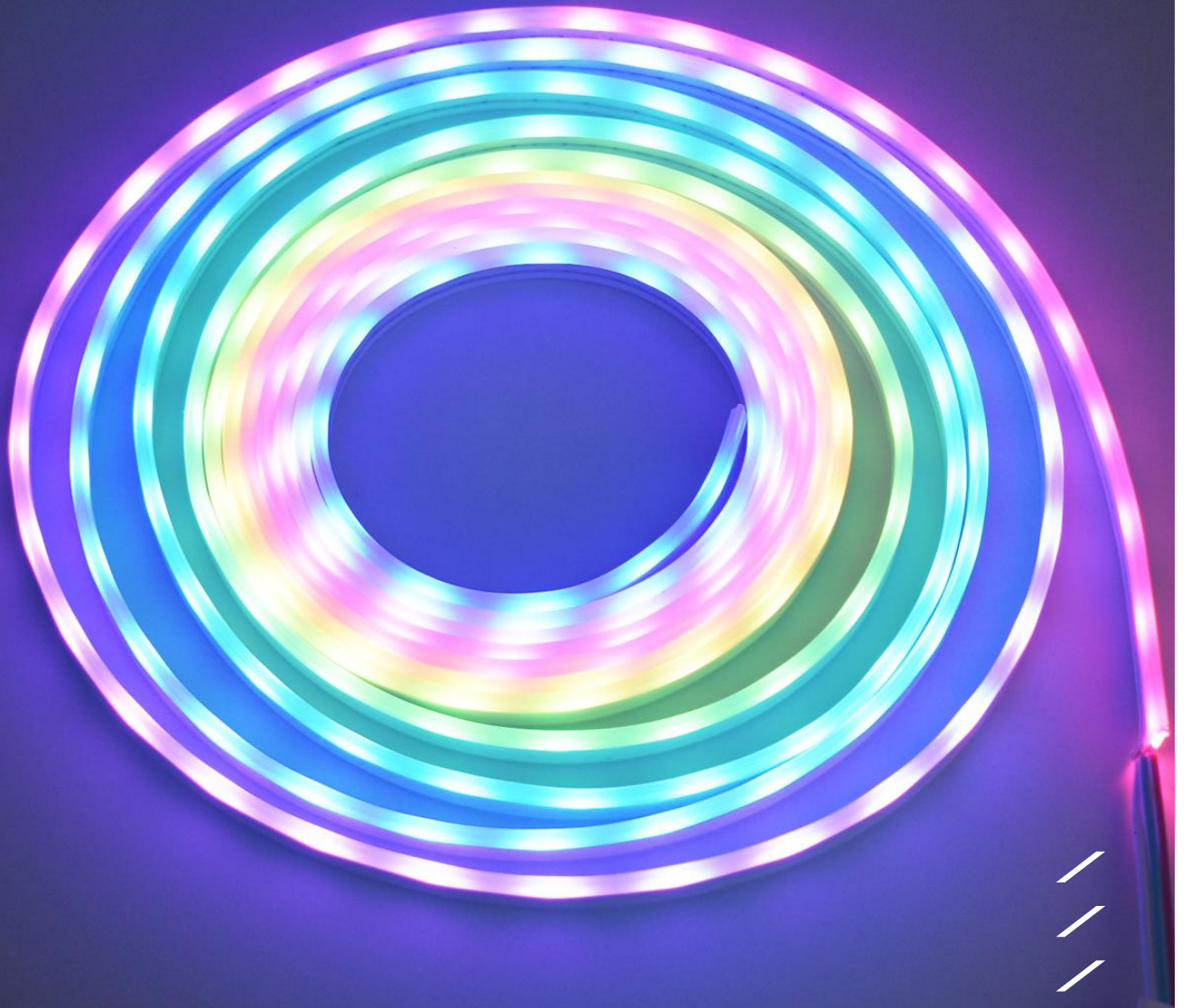

LED SHEET

Long Style

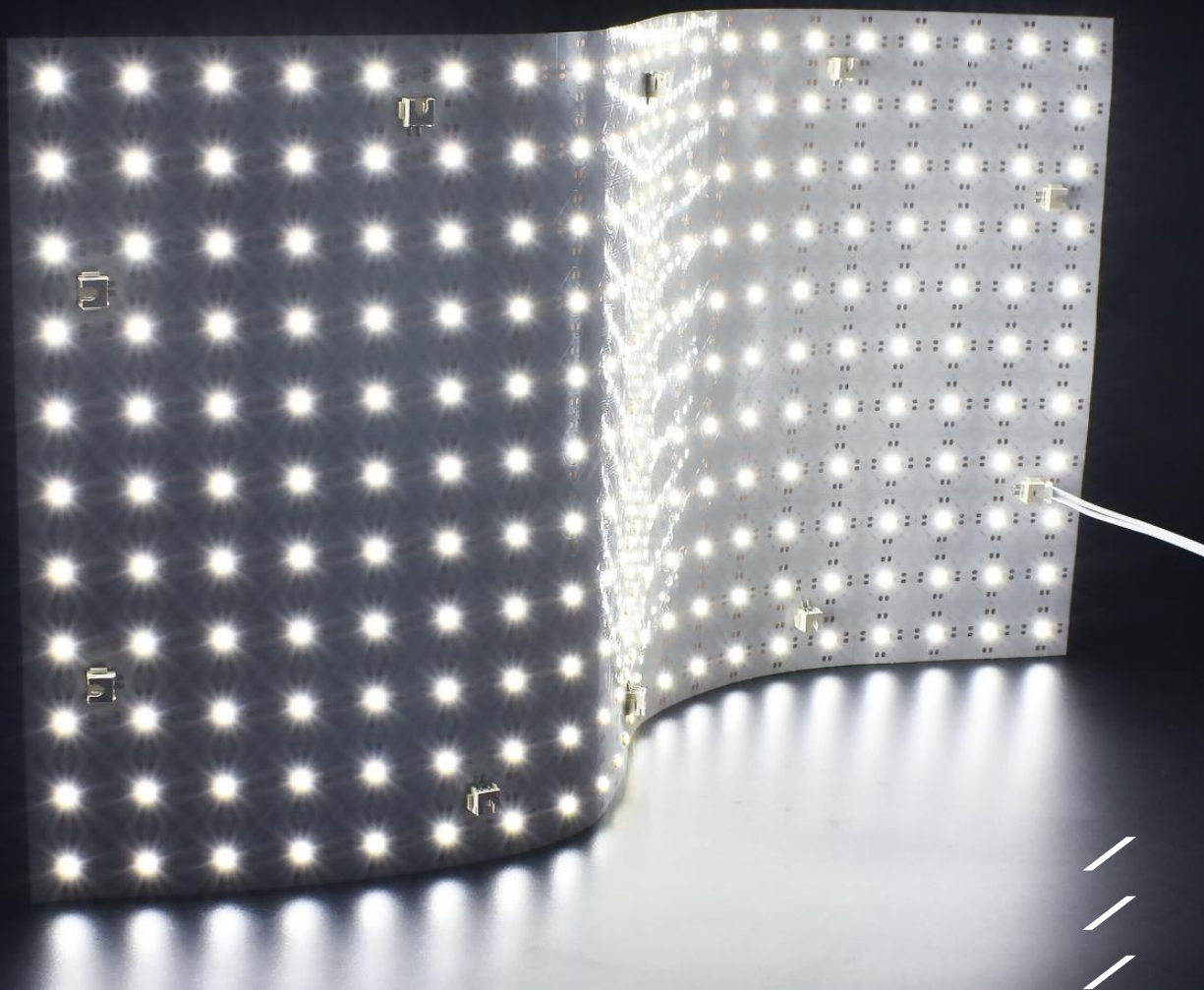

LED SHEET

Square Style

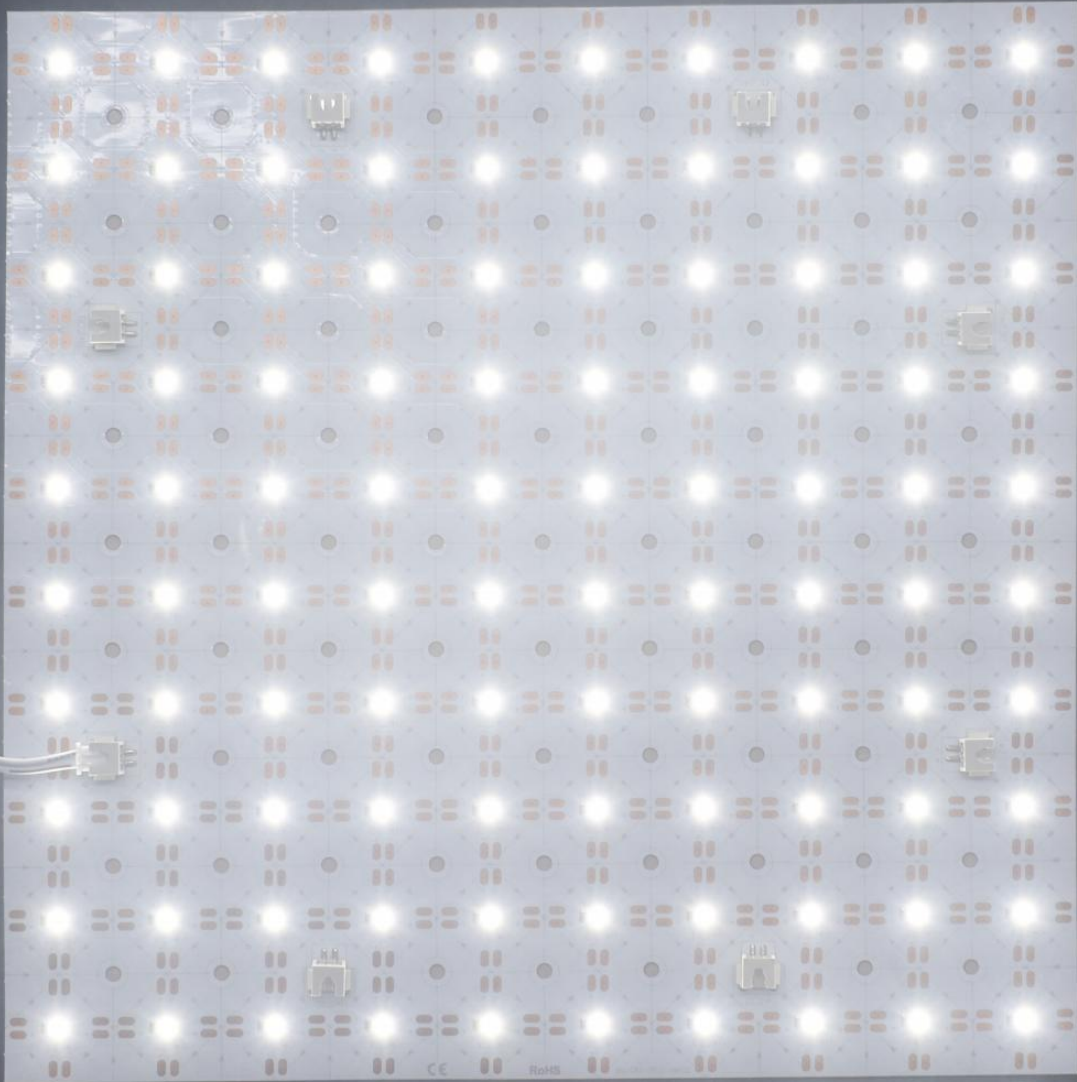

LED SHEET

Lens Style

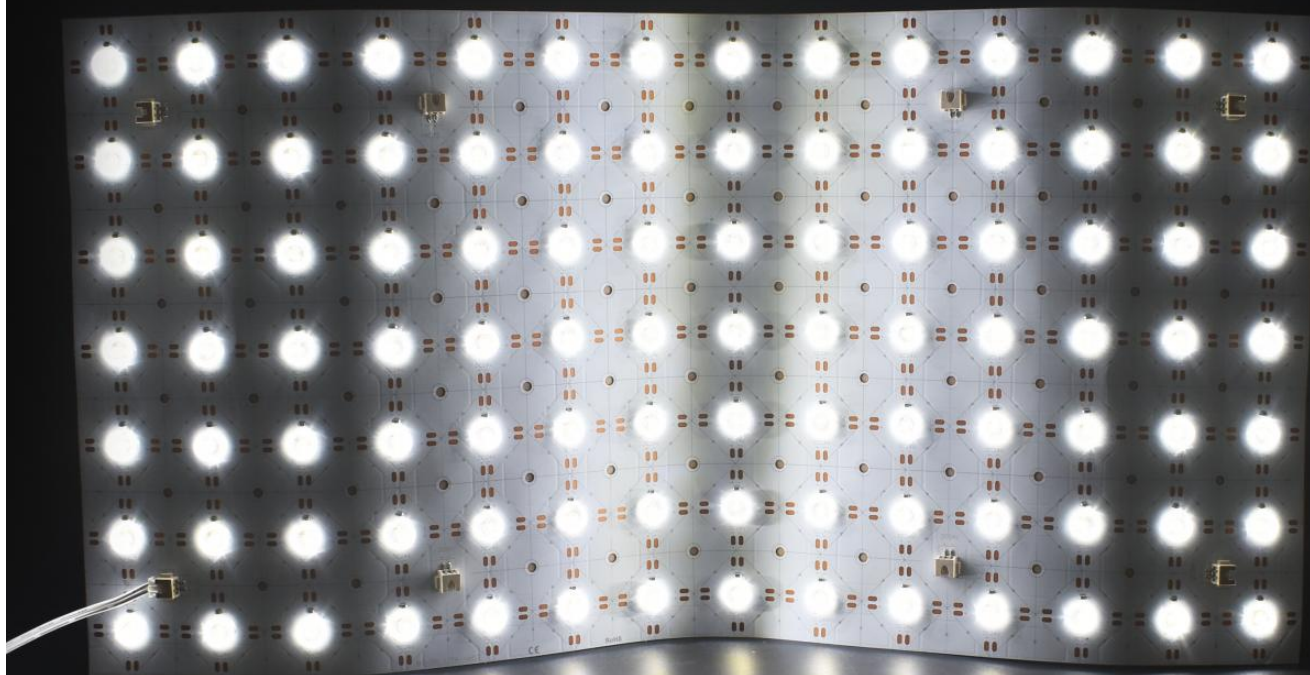

Lens Style LED Sheet/透镜款灯片



DIY Styling - 自由造型 -

PCB material: FPC double sides copper

PCB材质: FPC双面铜

Life Span: >36000hours

产品寿命: >36000小时

Warranty: 3 years

质保时间: 3年

Application:

Home decoration lighting

家居装饰照明

Light box lighting stage lighting

灯箱照明舞台照明

Decoration of entertainment places

娱乐场所装修

Other auxiliary lighting

其他辅助照明

CCT Range/色温范围

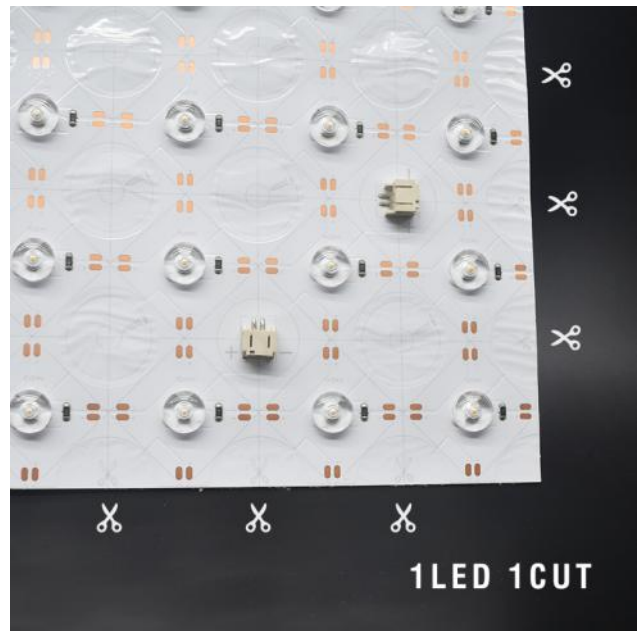
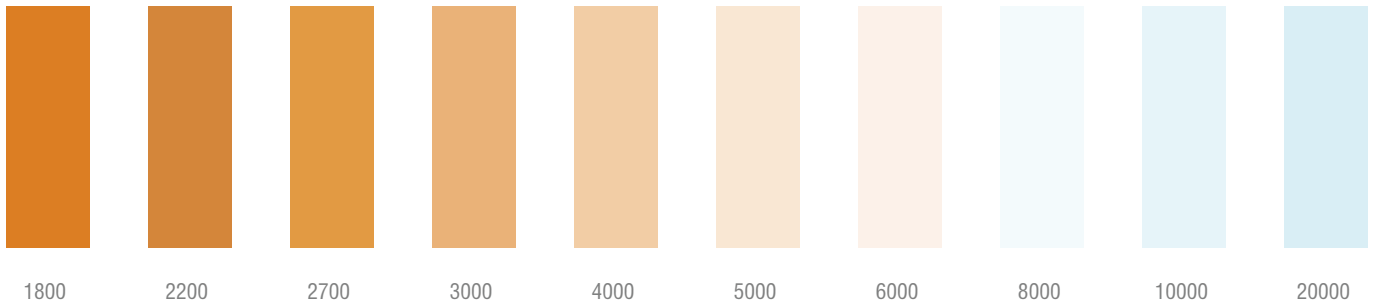

NO. 型号	VOLTAGE 电压(DC)	POWER 功率	LED QTY. 灯珠数量	LED TYPE 灯珠型号	Cut Length 剪切长度	SIZE 尺寸	IP Grade 防水等级	Color 颜色
BG-298-2835-98	24V	20 W	98 pcs	SMD2835	22.3x22.3mm	500x250mm	IP20/IP54	2200-6500K

Flex Wall Washer light

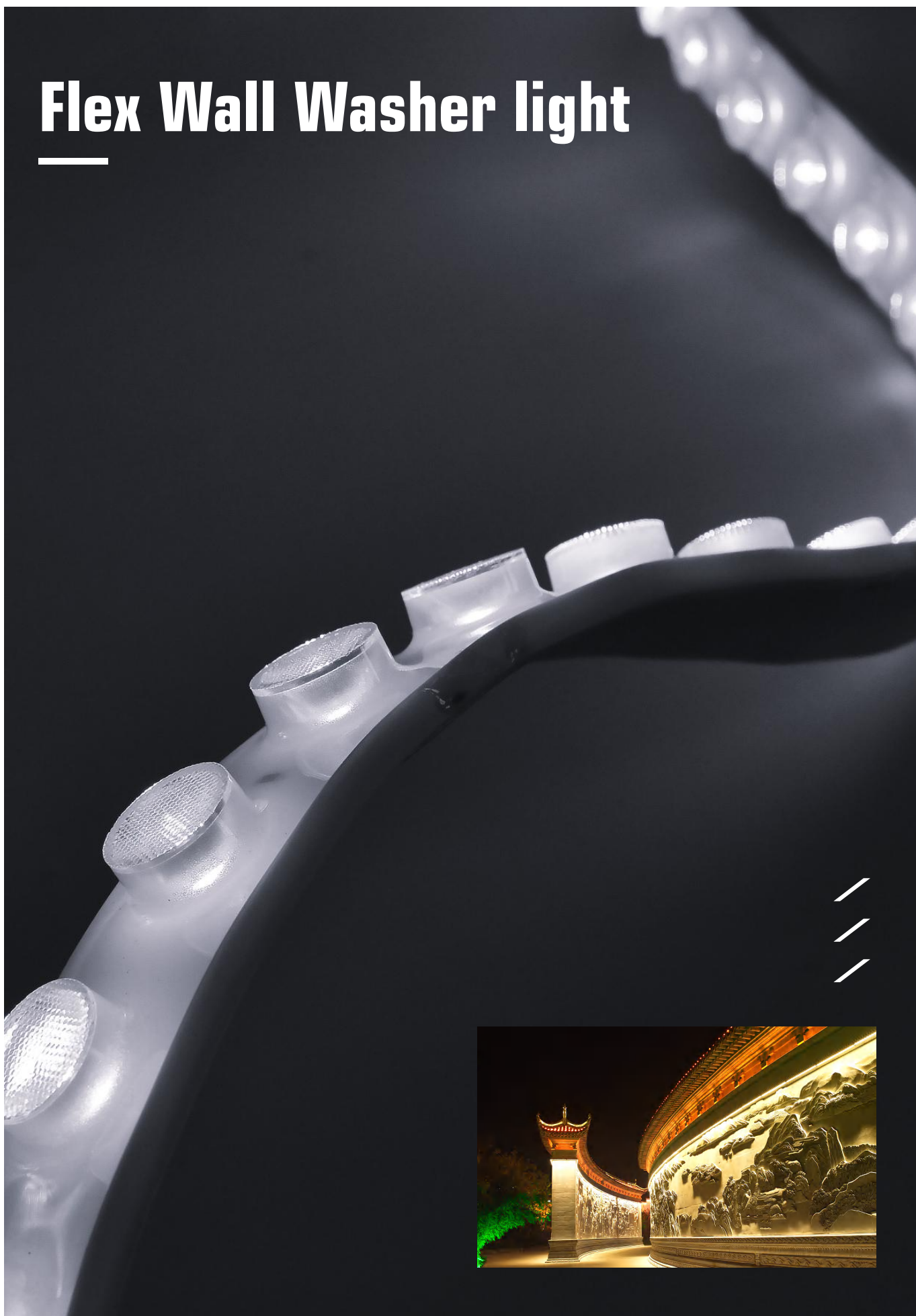

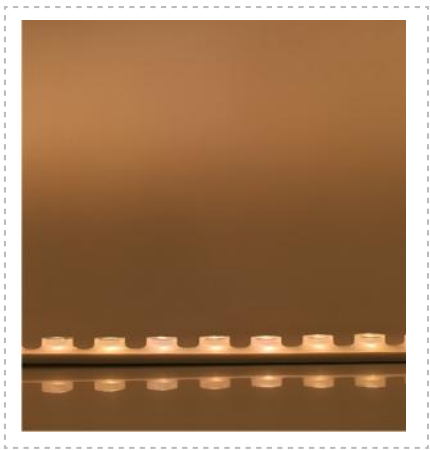

Flex LED Wall Wash Light/柔性洗墙灯

Multi-angle lens optional

- 多角度透镜可选 -

PCB material: FPC double sides copper

PCB 材质: FPC 双面铜

Life Span: >36000hours

产品寿命: >36000小时

Warranty: 3 years

质保时间: 3年

Application:

Interior design

室内设计

Architectural decoration

建筑装饰

Billboard decoration

广告牌装饰

Display design

展示设计

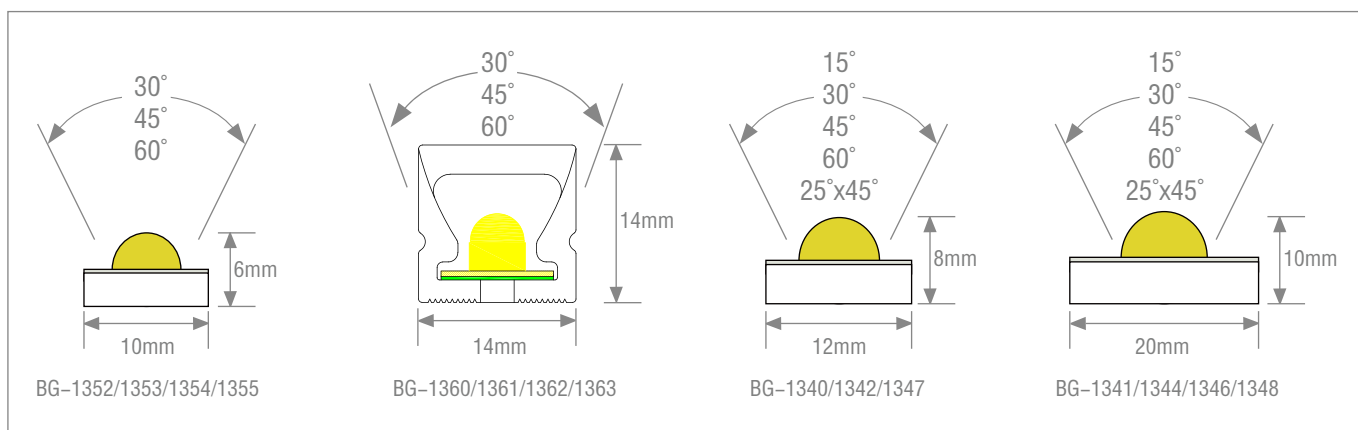

NO. 型号	VOLTAGE 电压(DC)	POWER 功率	LED QTY. 灯珠数量	SIZE 尺寸	CRI 显指	IP Grade 防水等级	Illuminated Height 照射高度	Beam Angle 光束角度	Color 颜色
BG-1352-90	24V	18 W	90 pcs/m	10x6mm	>90	IP 20	≤3M	30°/60°	White
BG-1353-60	12V/24V	18 W	60 pcs/m	10x6mm	>80	IP 20	≤3M	30°	White
BG-1354-60	12V/24V	18 W	60 pcs/m	10x6mm	/	IP 20	≤4M	45°	RGB
BG-1355-60	24V	14 W	60 pcs/m	10x6mm	/	IP 20	≤4M	45°	RGB Pixels
BG-1360-90	24V	18 W	90 pcs/m	14x14mm	>90	IP 66	≤3M	30°/60°	White
BG-1361-60	12V/24V	18 W	60 pcs/m	14x14mm	>80	IP 66	≤3M	30°	White
BG-1362-60	12V/24V	18 W	60 pcs/m	14x14mm	/	IP 66	≤4M	45°	RGB
BG-1363-60	24V	14 W	60 pcs/m	14x14mm	/	IP 66	≤4M	45°	RGB Pixels
BG-1340-56	24V	14.4 W	56 pcs/m	12x8mm	>90	IP 67	≤5M	15°/30°/45°/60° 25°x45°	White
BG-1341-24	24V	18 W	24 pcs/m	20x10mm	>80	IP 67	≤5M	15°/30°/45°/60° 25°x45°	White
BG-1346-48	24V	18 W	48 pcs/m	20x10mm	>80	IP 67	≤5M	15°/30°/45°/60° 25°x45°	White
BG-1342-56	24V	19.2 W	56 pcs/m	12x8mm	>80	IP 67	≤5M	15°/30°/45°/60° 25°x45°	CCT
BG-1344-28	24V	18 W	28 pcs/m	20x10mm	>80	IP 67	≤5M	15°/30°/45°/60° 25°x45°	RGBW
BG-1347-56	24V	18 W	56 pcs/m	12x8mm	>90	IP 67	≤5M	15°/30°/45°/60° 25°x45°	White Pixels
BG-1348-28	24V	18 W	28 pcs/m	20x10mm	/	IP 67	≤5M	15°/30°/45°/60° 25°x45°	RGBW Pixels



LED Grow Light (Flowing Gold Series) 2.7–3.0 $\mu\text{mol}/\text{J}$

Planting Environment:

Mainly glass greenhouses and plastic greenhouses.

Planting Range:

1. Large-scale planting of medicinal materials
2. Large-scale vegetables cultivation
3. Flower plants cultivation
4. Large-scale fruits planting
5. Large-scale cannabis cultivation

Irradiation Distance:

About 0.5–1m away from the plant.

Knob + 0–10V Dimmable

Multi channel optional

5 Years warranty

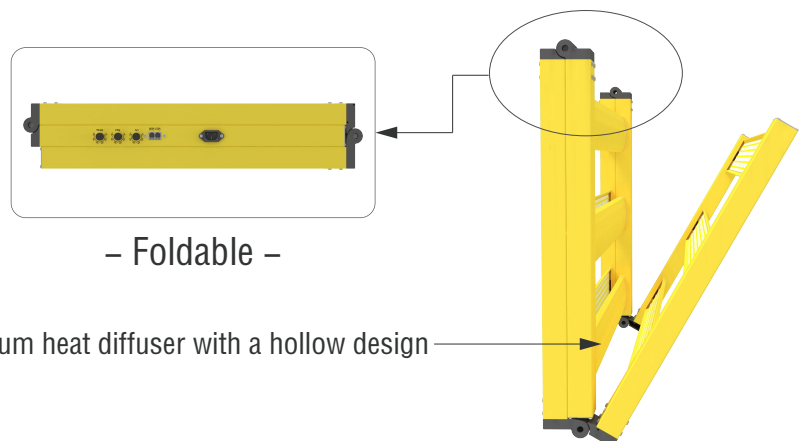

– Foldable –

Pure aluminum heat diffuser with a hollow design

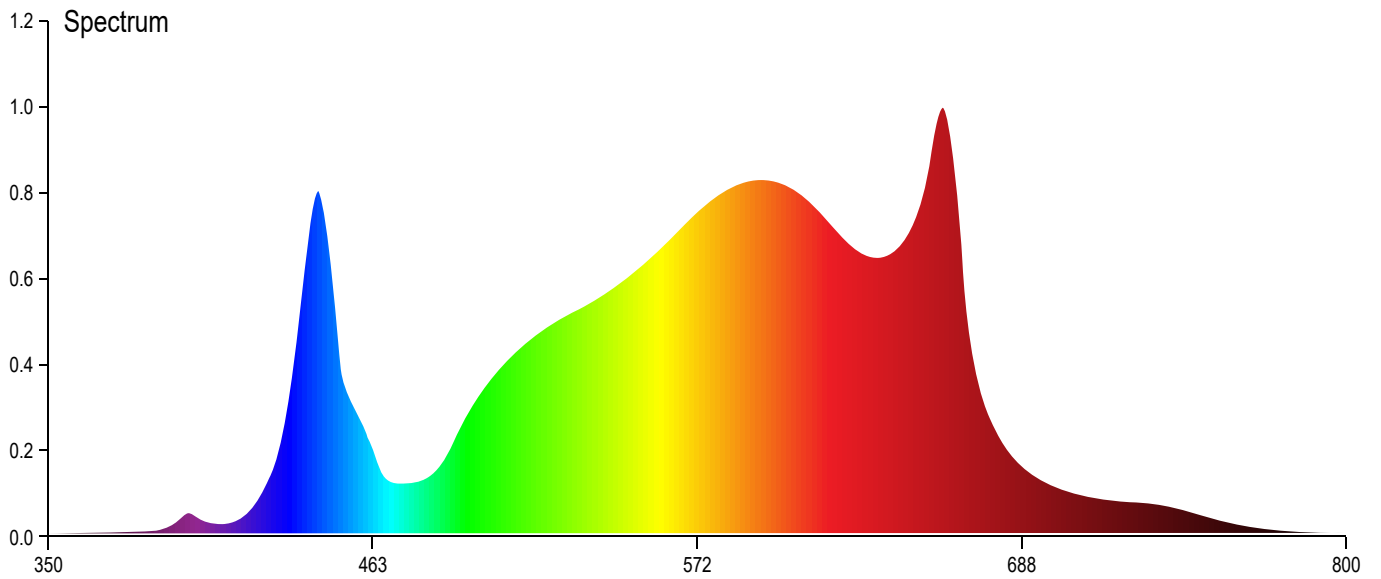

NO.	PPF (umol/s)	IP Grade	Voltage (Vac)	Power (W)	Product Size (mm)	LED QTY:
Flowing Gold-C1-1500	3500-3800	IP65	100-277	1500	1868*1105*42	Full spectrum LED
Flowing Gold-C2-1500	3500-3800	IP65	100-277	1500	1868*1105*42	Full spectrum LED +660nm+730nm LED
Flowing Gold-C3-1500	3500-3800	IP65	100-277	1500	1868*1105*42	Full spectrum LED +660nm+730nm+U385nm LED



LED Grow Light (Eagle Series) 2.7–2.9 $\mu\text{mol}/\text{J}$

Original Samsung (LM301B/ LM301H) LED/ OSRAM LED

Planting Environment:

Mainly glass greenhouses and plastic greenhouses.

Planting Range:

1. Large-scale planting of medicinal materials
2. Large-scale vegetables cultivation
3. Flower plants cultivation
4. Large-scale fruits planting
5. Large-scale cannabis cultivation

Irradiation Distance:

About 0.5–1m away from the plant.

Knob + 0–10V Dimmable

Multi channel optional

5 Years warranty

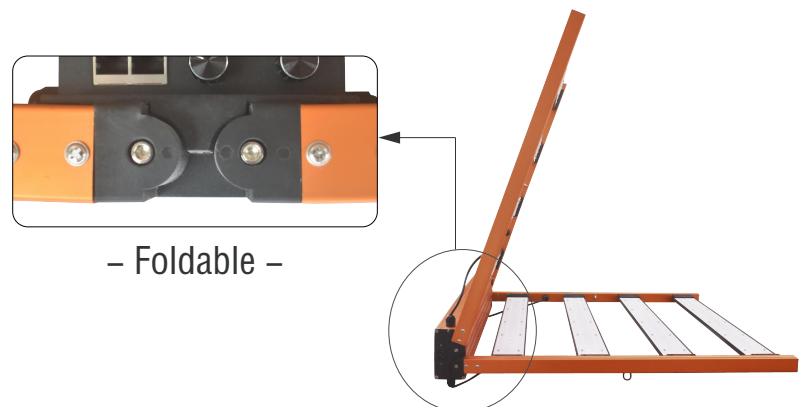

– Foldable –

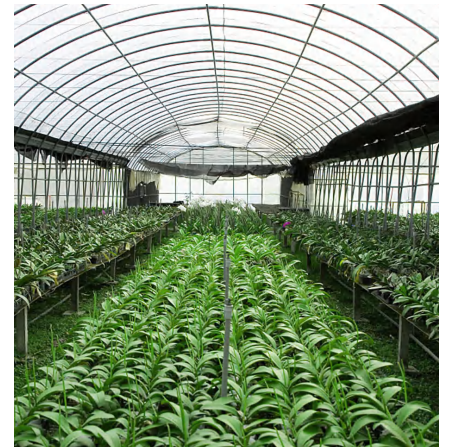
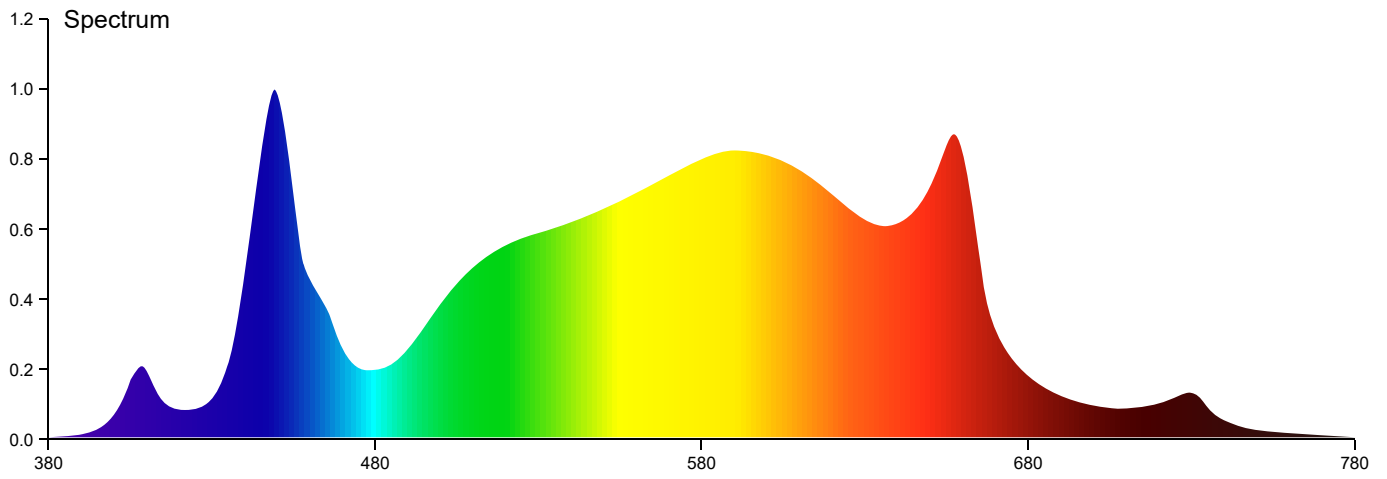

NO.	PPF (umol/s)	IP Grade	Voltage (Vac)	Power (W)	Product Size (mm)	LED QTY:
Eagle-C1-600	1620-1800	IP65	100-277	600	1194*1026*68	Full spectrum LED
Eagle-C1-1000	2700-3000	IP65	100-277	1000	1498*1026*68	Full spectrum LED
Eagle-C2-1000	2700-3000	IP65	100-277	1000	1498*1087*68	Full spectrum LED +660nm+730nm LED
Eagle-C3-1000	2700-3000	IP65	100-277	1000	1498*1087*68	Full spectrum LED +660nm+730nm+U385nm LED



LED Grow Light (Gold Eagle Series) 2.9–3.0 $\mu\text{mol}/\text{J}$

Planting Environment:

Mainly glass greenhouses and plastic greenhouses.

Planting Range:

1. Large-scale planting of medicinal materials
2. Large-scale vegetables cultivation
3. Flower plants cultivation
4. Large-scale fruits planting
5. Large-scale cannabis cultivation

Irradiation Distance:

About 0.5–1m away from the plant.

Knob + 0–10V Dimmable

Multi channel optional

5 Years warranty

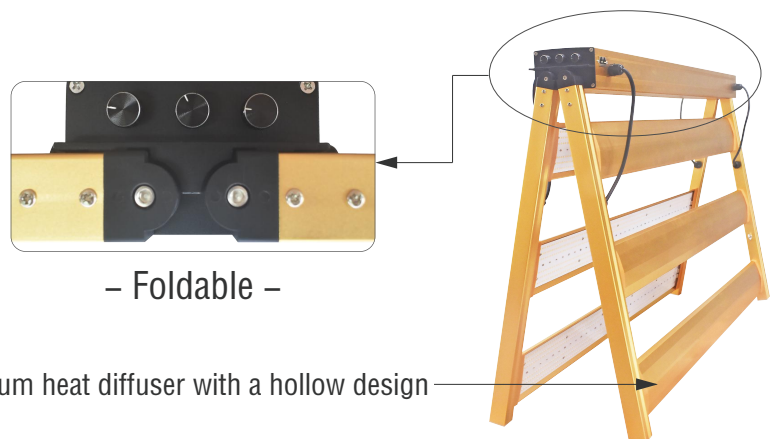

– Foldable –

Pure aluminum heat diffuser with a hollow design

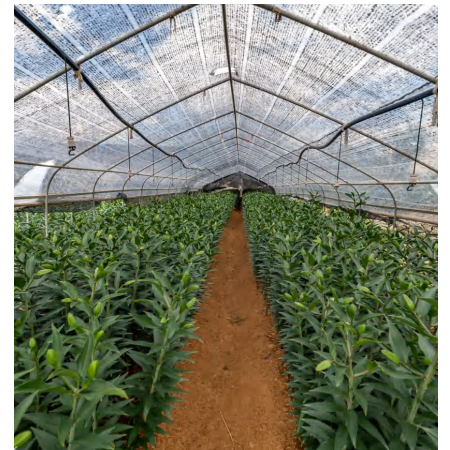
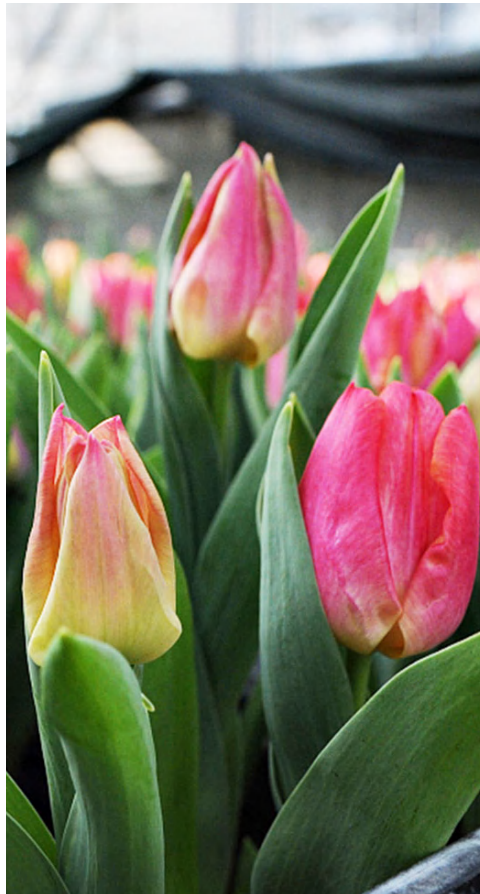
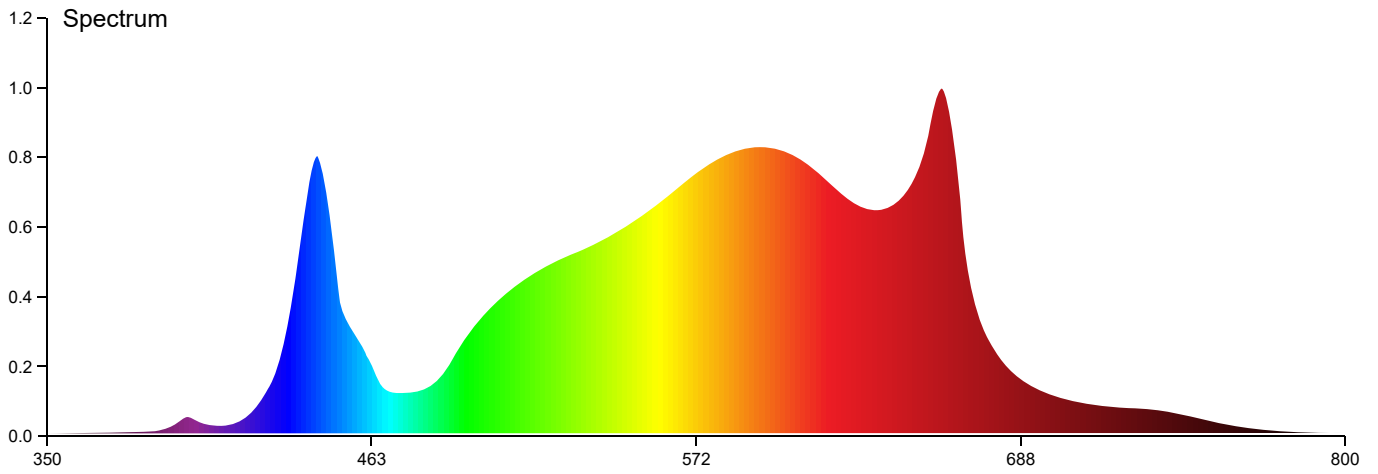

NO.	PPF (umol/s)	IP Grade	Voltage (Vac)	Power (W)	Product Size (mm)	LED QTY:
Gold Eagle-C1-600	1620-1800	IP65	100-277	600	1255*1087*68	Full spectrum LED
Gold Eagle-C1-1000	2700-3000	IP65	100-277	1000	1255*1087*68	Full spectrum LED
Gold Eagle-C2-1000	2700-3000	IP65	100-277	1000	1255*1087*68	Full spectrum LED +660nm+730nm LED
Gold Eagle-C3-1000	2700-3000	IP65	100-277	1000	1255*1087*68	Full spectrum LED +660nm+730nm+U385nm LED



LED Grow Light (Cobra Series) 2.7–3.0 $\mu\text{mol}/\text{J}$

Planting Environment:

Mainly glass greenhouses and plastic greenhouses.

Planting Range:

1. Large-scale planting of medicinal materials
2. Large-scale vegetables cultivation
3. Flower plants cultivation
4. Large-scale fruits planting
5. Large-scale cannabis cultivation

Irradiation Distance:

Close to plant.

PMW/0–10V Dimmable

3 Years warranty

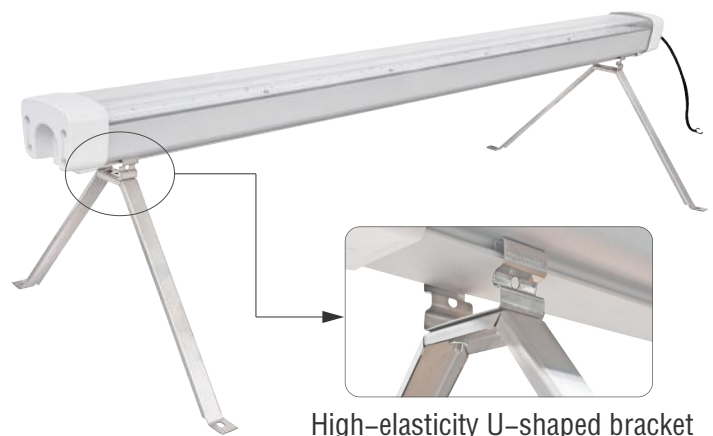

High-elasticity U-shaped bracket

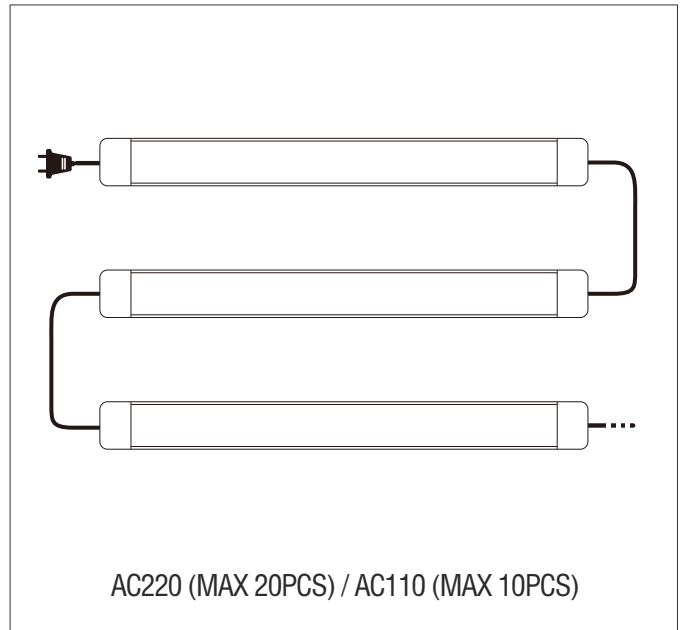
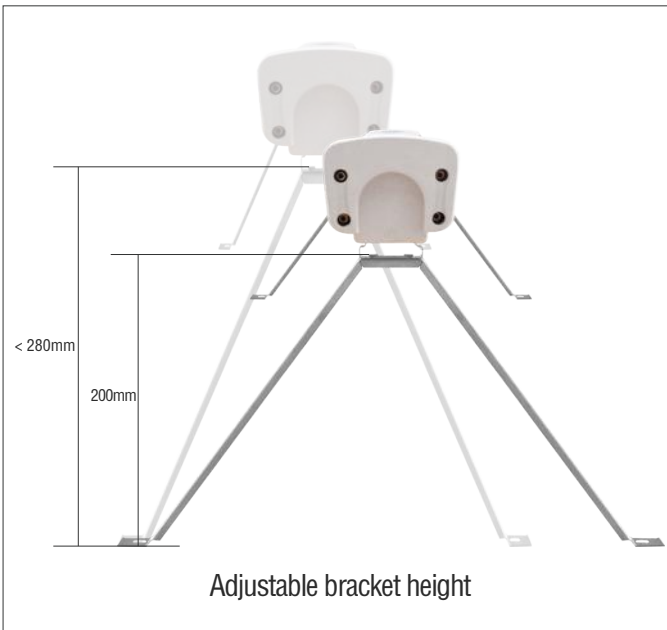
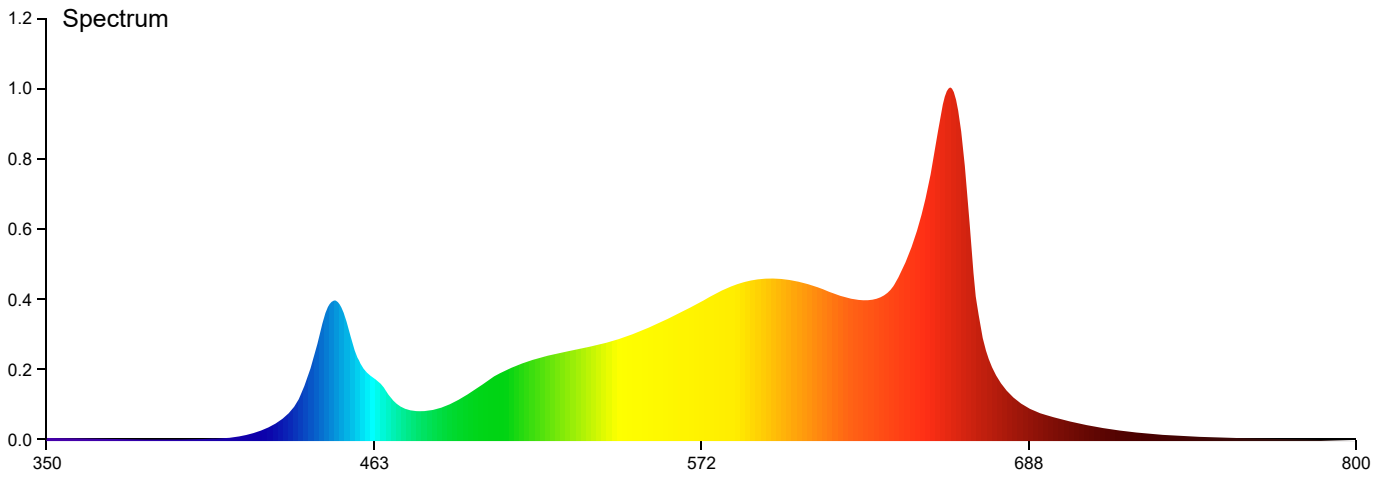

NO.	PPF (umol/s)	IP Grade	Voltage (Vac)	Power (W)	Product Size (mm)	LED QTY:
Cobra-A-100	2700-3000	IP65	108-305	100	1145*85*68	Full spectrum LED + 600nm LED



LED Grow Light (Tube Series) 2.0–2.2 $\mu\text{mol}/\text{J}$

Planting Environment:

Mainly glass greenhouses and plastic greenhouses.

Planting Range:

1. Large-scale planting of medicinal materials
2. Large-scale vegetables cultivation
3. Flower plants cultivation
4. Large-scale fruits planting
5. Large-scale cannabis cultivation

Irradiation Distance:

Close to plant.

3 Years warranty

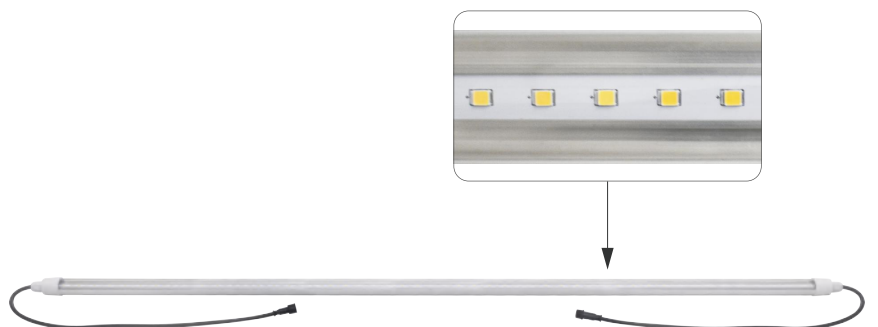

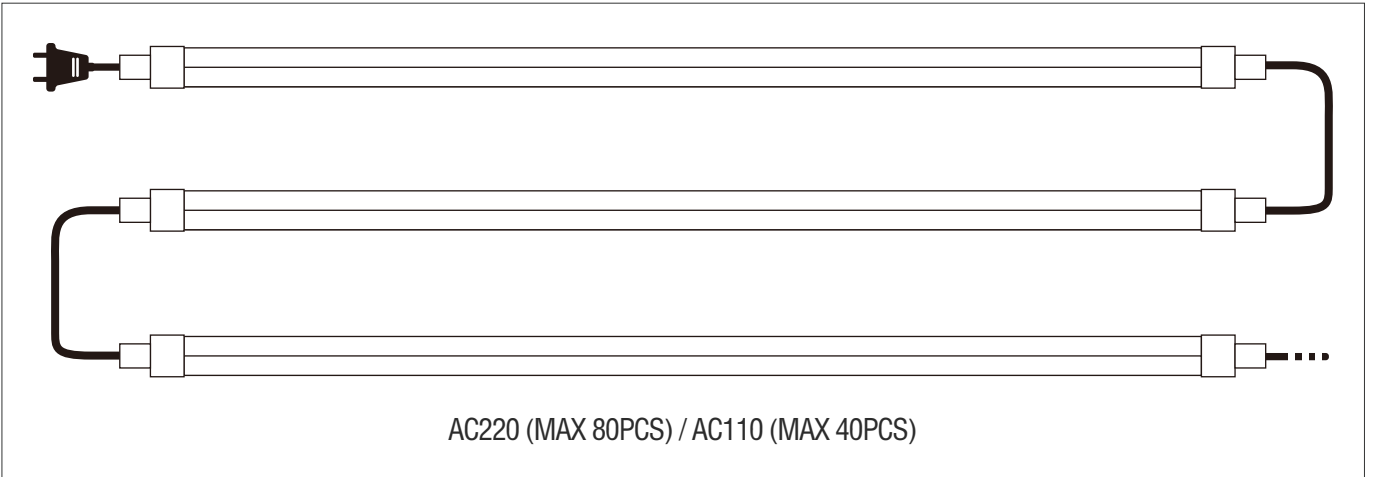
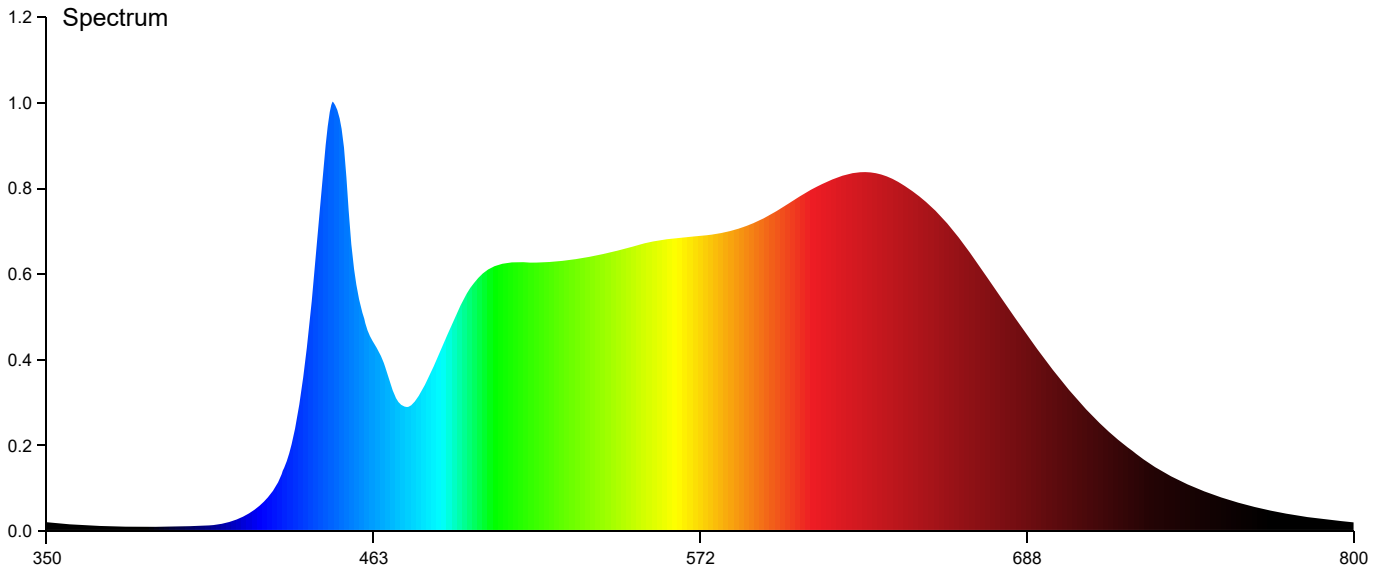

NO.	Power (W)	PPF (umol/s)	Voltage (Vac)	Light Efficiency (lm/W)	CRI	IP Grade	Product Size (mm)	LED QTY:
BG-T8-15	15	22-26	200-240	118	>98	IP65	φ 26 x L890	3000K/4000K/5000K/6000K
BG-T8-18	18	35-38	220-240	112	>98	IP65	φ 28 x L1145	3000K/4000K/5000K/6000K

LED Grow Light (Downlight Series)



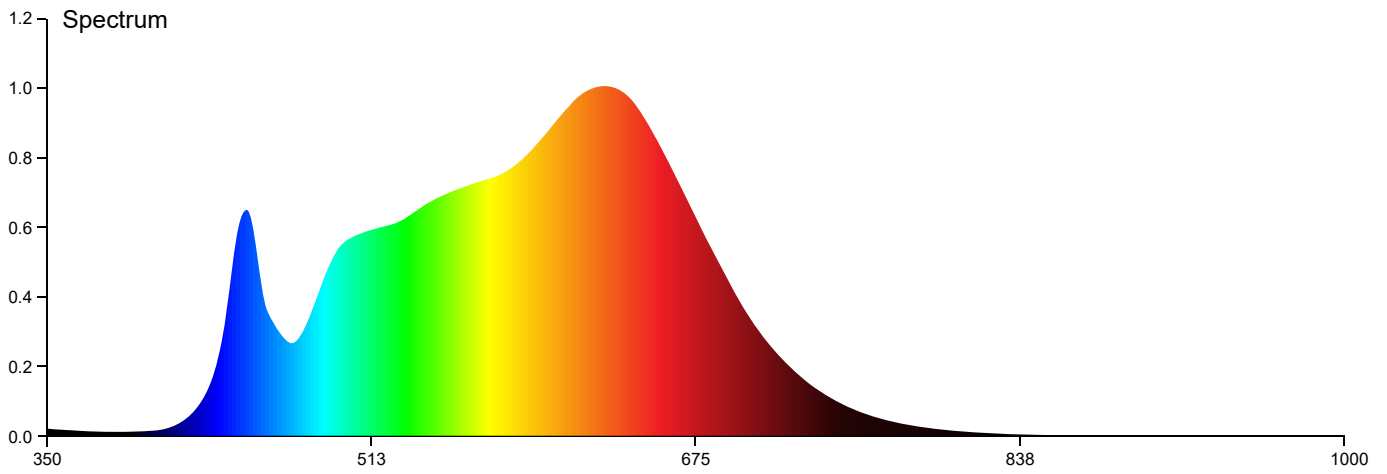

NO.	PPF (umol/s)	Product Size (mm)	Hole Size (mm)	Power (W)	Light Efficiency (lm/W)	CRI	Voltage (Vac)	LED QTY:
BG-CL8WA77	11-13	φ 77 x H65	φ 65 - 70	8	>75	>98	200-240	3000K/3500K/5000K
BG-CL15WA88	18-22	φ 88 x H80	φ 75 - 80	15	>75	>98	200-240	3000K/3500K/5000K
BG-CL15WA110	18-22	φ 110 x H80	φ 95 - 100	15	>80	>98	200-240	3000K/3500K/5000K
BG-CL32WA170	55-65	φ 170 x H120	φ 145 - 155	32	>95	>98	200-240	3000K/3500K/5000K

LED Grow Light (Spotlight Series)



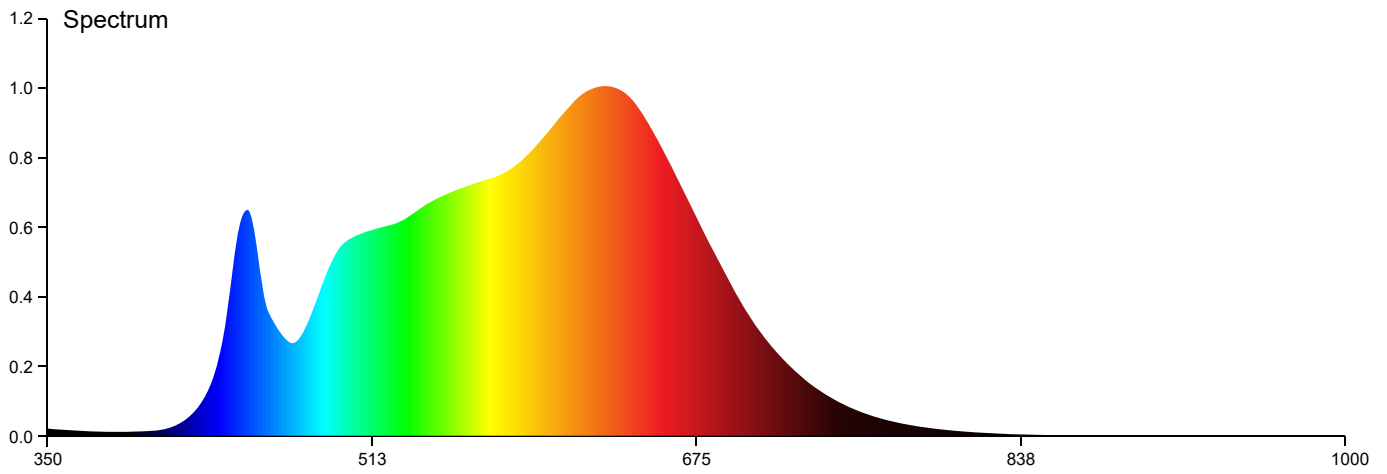

NO.	PPF (umol/s)	Product Size (mm)	Power (W)	Light Efficiency (lm/W)	CRI	Voltage (Vac)	LED QTY:
BG-TL15WEC55	20-24	φ 55 x L120	15	>75	>98	200-240	3000K/3500K/5000K
BG-TL36WEC88	62-74	φ 88 x L160	36	>85	>98	200-240	3000K/3500K/5000K

LED Grow Light (Pendant Light Series)



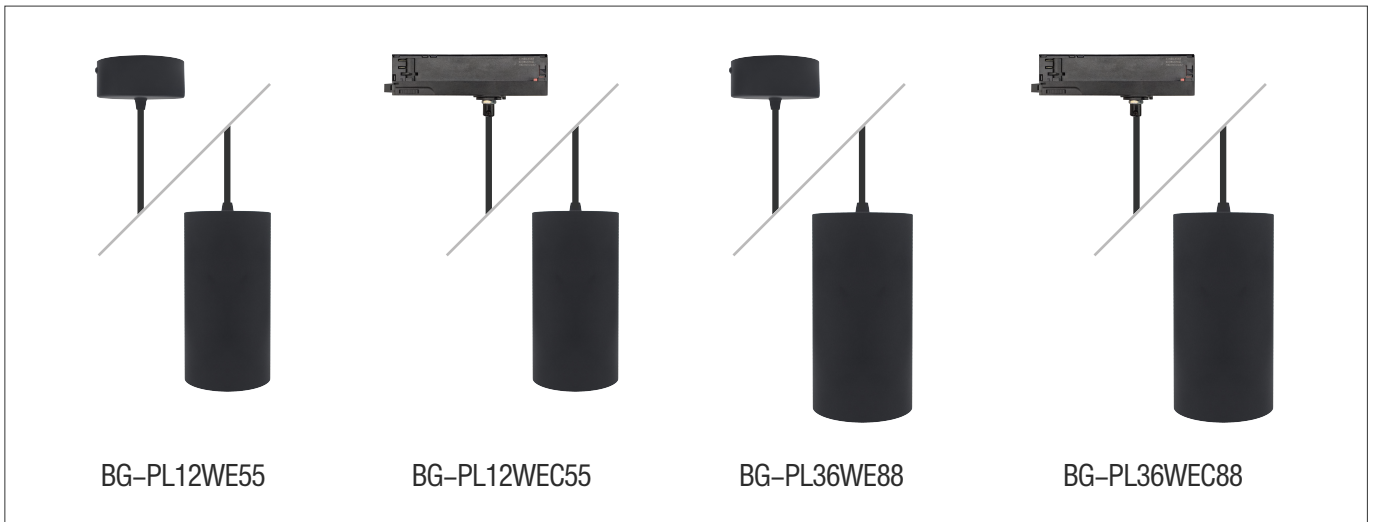
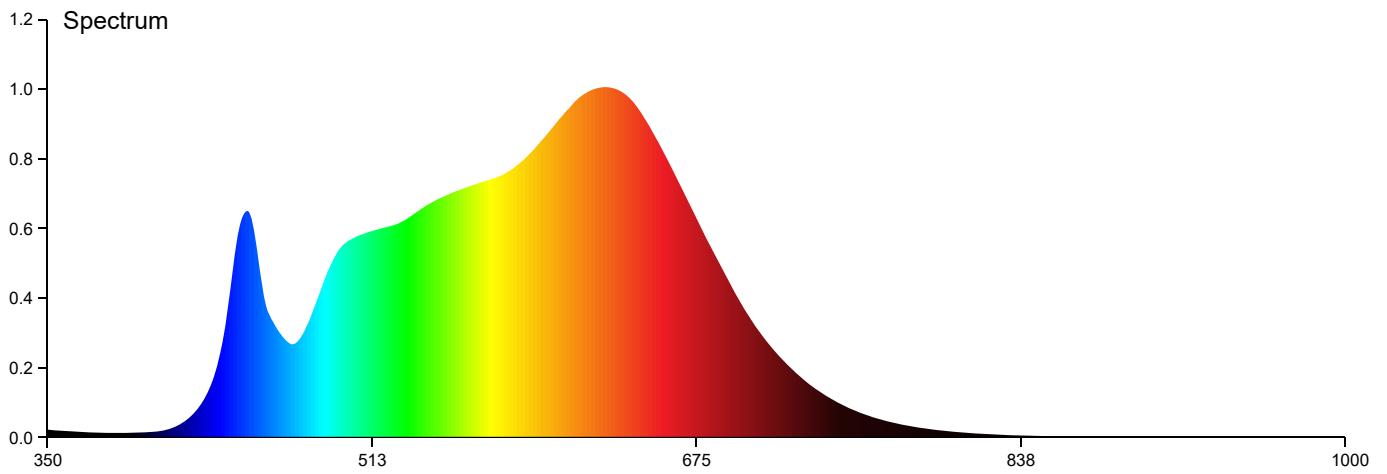

NO.	PPF (umol/s)	Product Size (mm)	Power (W)	Light Efficiency (lm/W)	CRI	Voltage (Vac)	LED QTY:
BG-PL12WE55	16-20	φ 55 x H150	12	>85	>98	200-240	3000K/3500K/5000K
BG-PL12WEC55	15-18	φ 55 x H150	12	>80	>98	200-240	3000K/3500K/5000K
BG-PL36WE88	60-70	φ 88 x H175	36	>85	>98	200-240	3000K/3500K/5000K
BG-PL36WEC88	58-68	φ 88 x H175	36	>85	>98	200-240	3000K/3500K/5000K



POWER SUPPLY

— 电源 —

120W

240W

320W

480W

640W

960W



CONNECTOR/连接器

CONTROLLER/控制器

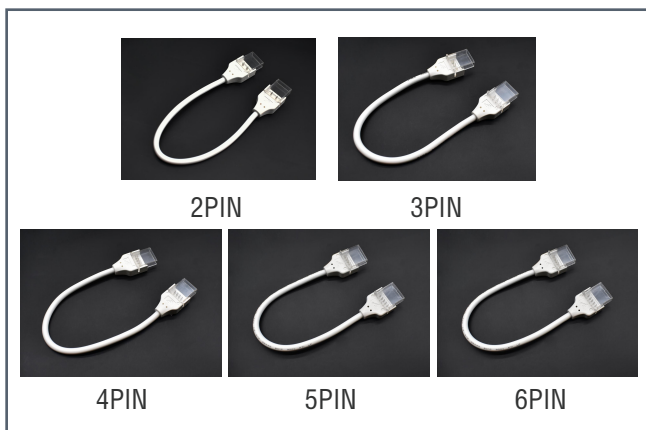
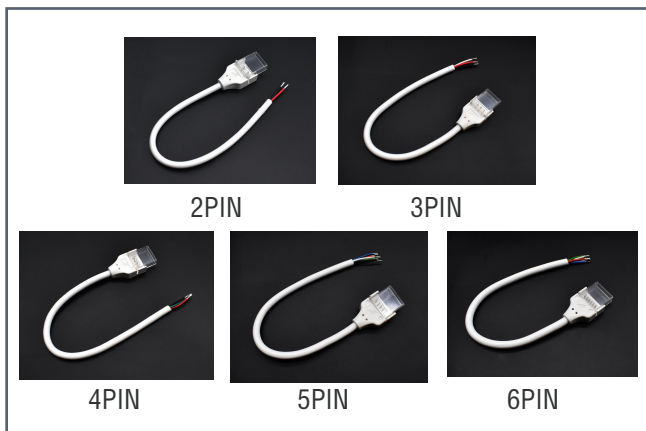
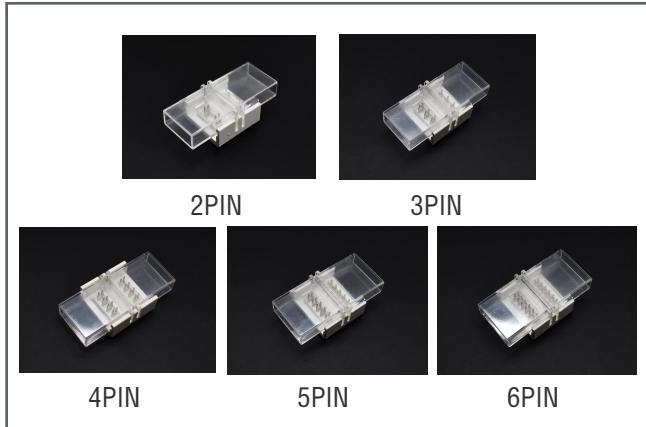

Accessories/配件



Aluminium Profiles/铝型材

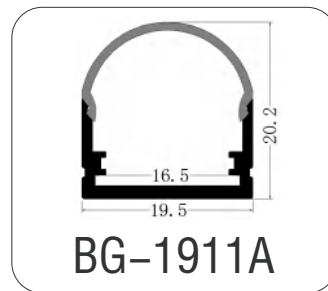
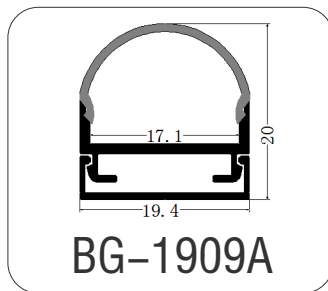
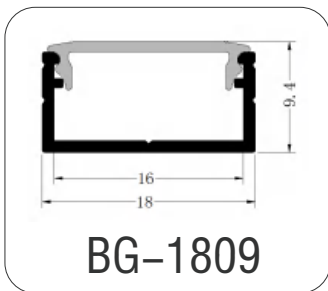
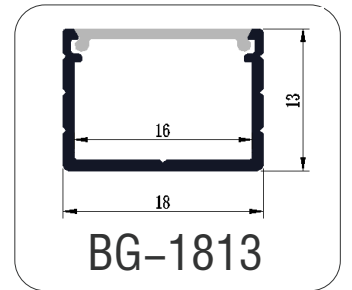
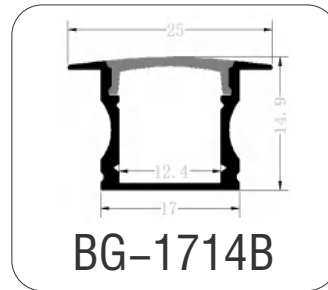
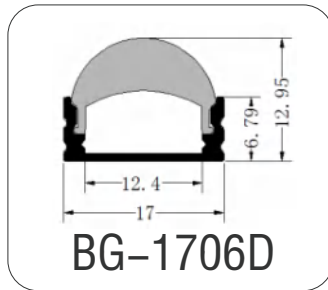
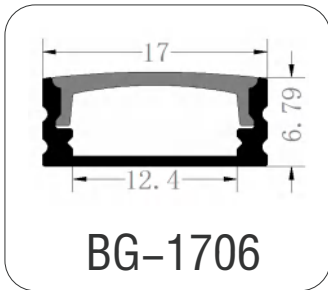
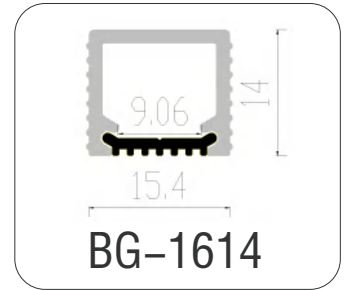
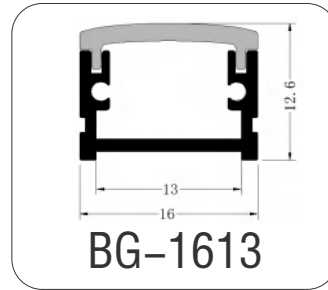
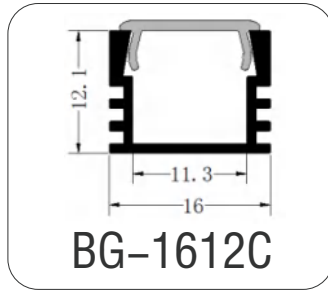
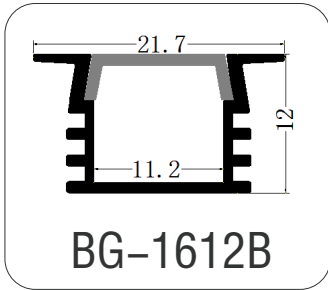
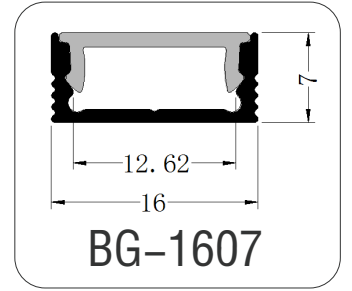
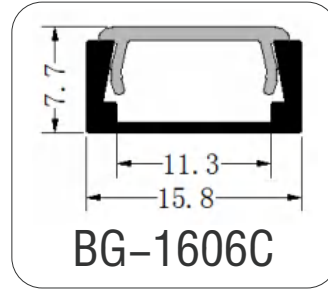
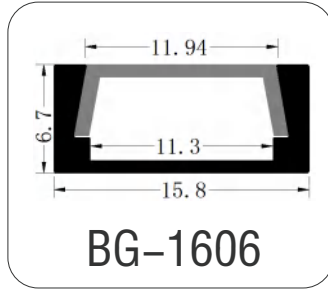
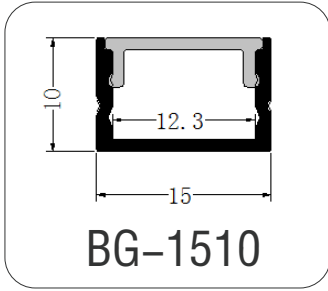
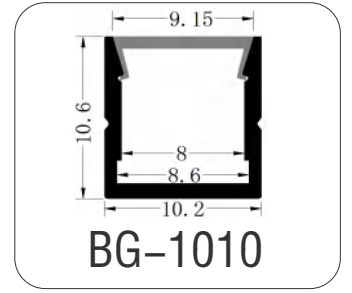
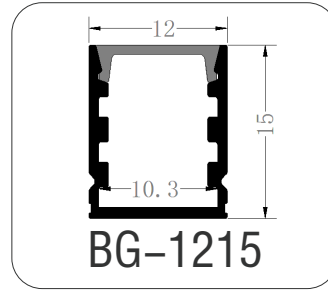
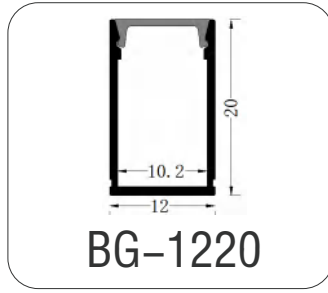
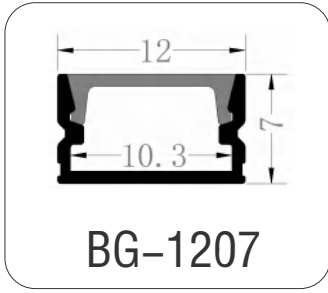
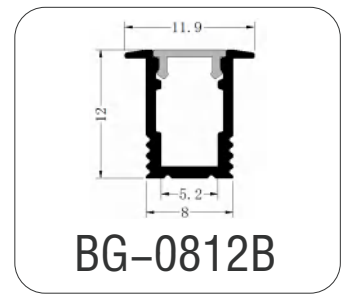
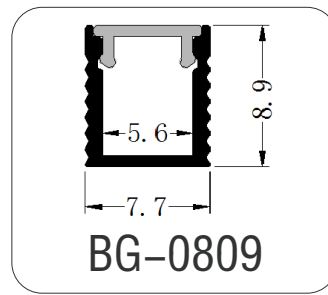
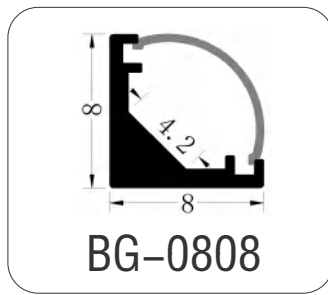
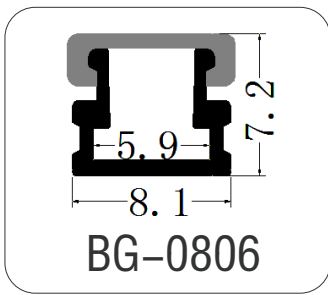

Aluminium Profiles/铝型材

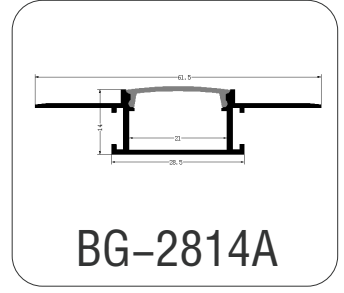
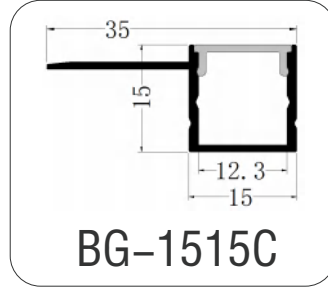
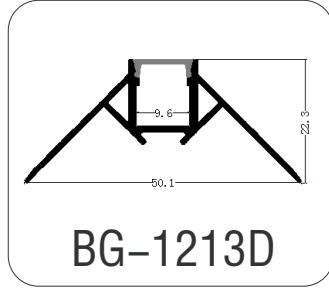
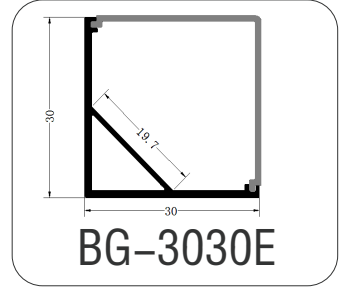
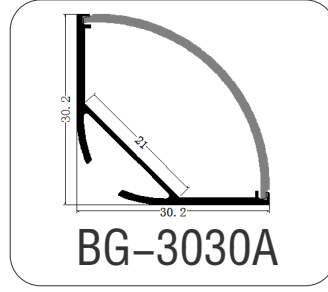
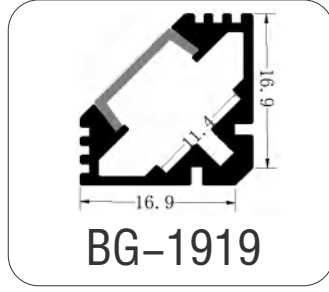
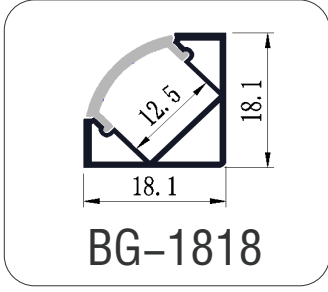
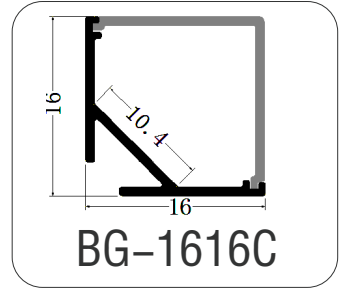
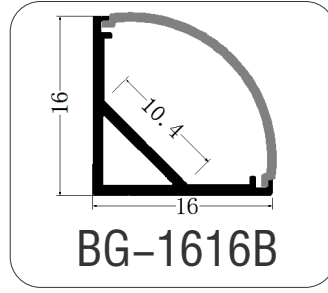
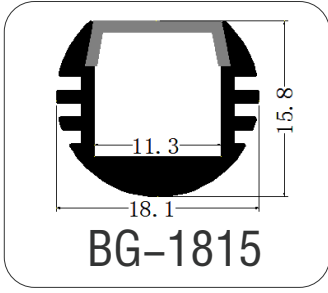
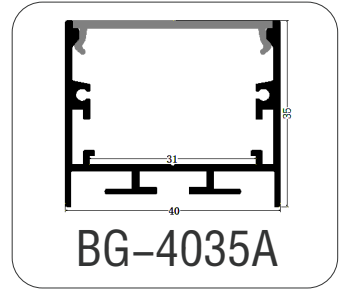
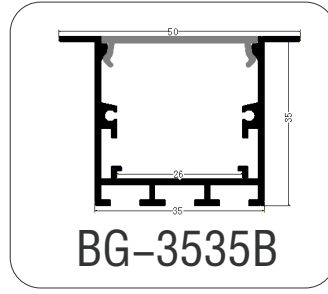
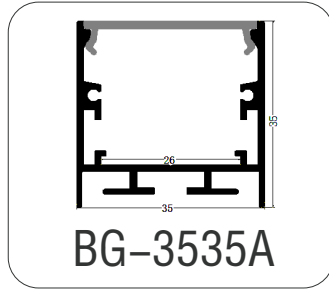
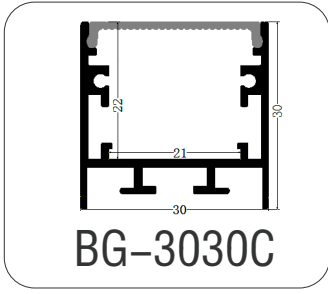
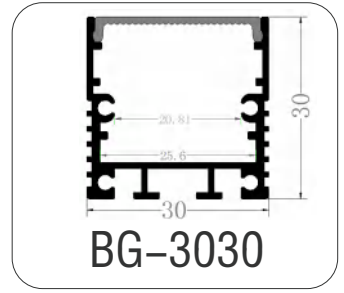
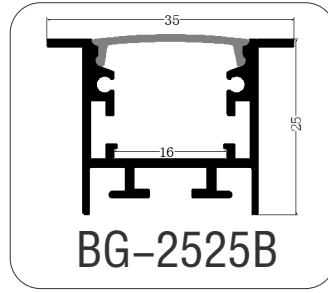
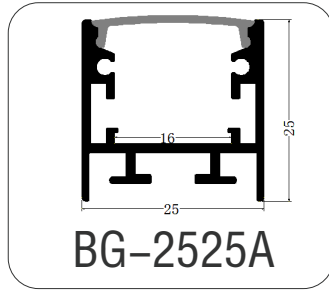
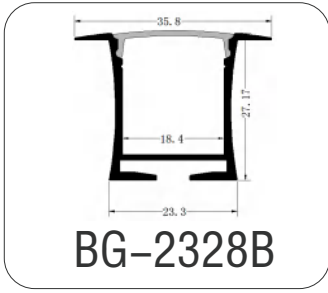
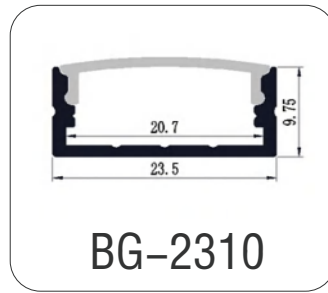
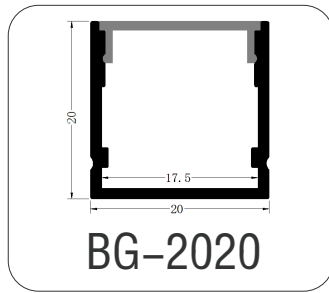
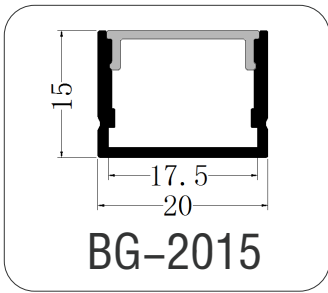



www.bright-est.com

Bright Technology Industrial Limited

Professional LED strip designer and manufacturer

Tel: (+86)755 3689 2679/(+86)755 3686 2182

Fax: (+86)755 3686 2183

E-mail: info@bright-est.com

Add: Building A, Baifuli Industrial Area, Huahui Road, Dalang, Longhua District,
Shenzhen City, Guangdong Province, China