



YOU LI CARBURETOR BUILDING LOBBY PROJECT

Project Introduction and Construction Overview

You-All Corporation was established in June 1996 and is a leading manufacturer in China for motorcycle carburetors and general gasoline engine carburetors. The company has the capacity to produce 16 million units per year of motorcycle carburetors, general gasoline engine carburetors, and electronic fuel injection systems. Yoyu Corporation has introduced 28 advanced "Sukiki" carburetor processing lines from Japan, as well as FANUC robot processing lines and assembly automation production lines. The company is equipped with 25 models of "Brother" machining centers, 30 units of "STAR" and "Seiki" CNC machine tools, and a Swiss "Micron" special machine capable of high precision and integration for multiple hole machining.

After several time meetings, You-All decided to give this task to PRANCE. Completing a high-end and demanding interior lobby project requires comprehensive planning, creativity, meticulous execution, and close collaboration with the client in order to meet our client expectations and create stunning interior design works.



Project Time:

January 2021

The Products We Provide:

Interior ceiling and wall cladding in anodized finished

Application Scope:

All area

Services We Provide:

Original Design, detailed the design, production, technical support





Challenge

The challenge lies in how to ensure the perfect implementation of the project. Therefore, in addition to having thorough communication and clearly defining the requirements in the initial stage, our PRANCE team also goes to the site with samples to discuss product details with the client. We also assist in selecting all the materials to ensure that the project can be perfectly executed. Because this project involves us providing original designs, we also offer tiles, doors, logo letters, and other materials to the client, aiming to provide our clients with meticulous service, which has always been the essence and mission of PRANCE.





Solution

The PRANCE team also arranged colleagues to be present at the site to address all client inquiries and finalize material selections. Additionally, based on the site conditions, we provided installation node diagrams and installation process schedules for each location. We established a dedicated project team to address all client pain points and ensure that every detail, big or small, is resolved. Whether the project is in China or overseas, based on our team's years of experience, clients can expect an excellent project experience.



Solution

Panel Pattern Direction

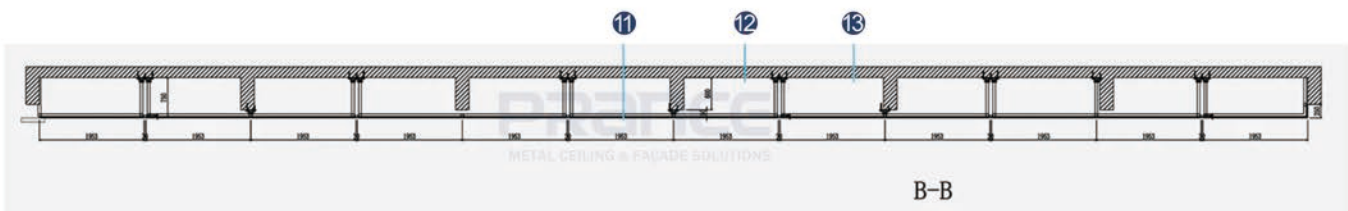
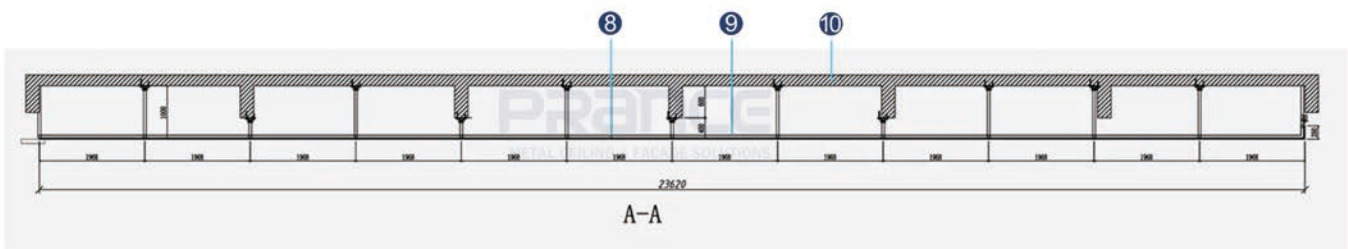
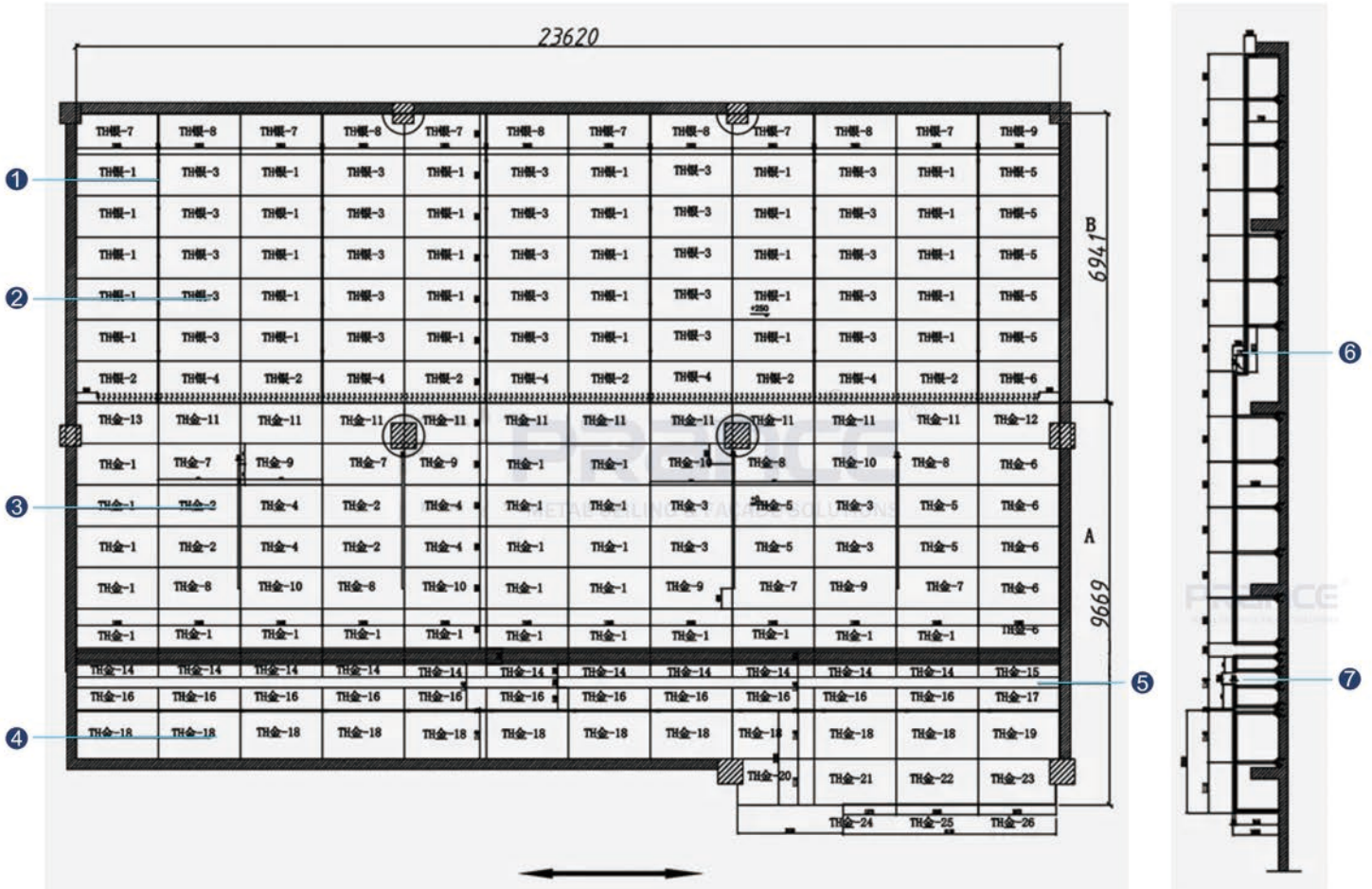

- | | |
|---|--|
| 1. Raise the corner codes around the light trough by 60mm | 2. TH银 means 2.5mm thick Silver Anodized Panel |
| 3. TH金 means 2.5mm thick Gold Anodized Panel | 4. TH金 means 2.5mm thick Gold Anodized Panel |
| 5. 250mm wide Return Air Vent | 6. 170mm wide Return Air Vent |
| 7. 250mm wide Return Air Vent | 8. 2.5mm thick Gold Anodized Panel |
| 9. 50*50 Steel Round Tube | 10. Concrete |
| 11. 2.5mm thick Silver Anodized Panel | 12. 50*50 Steel Round Tube |
| 13. Concrete | |

Solution

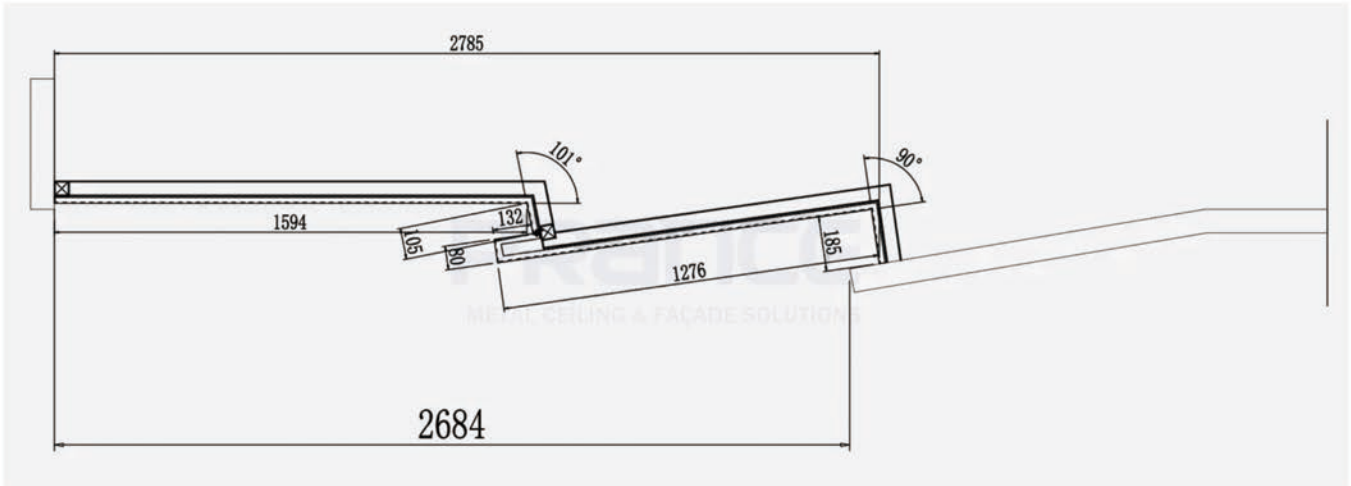

D金 means 2.5mm thick GoldAnodized Panel

Panel Pattern Direction

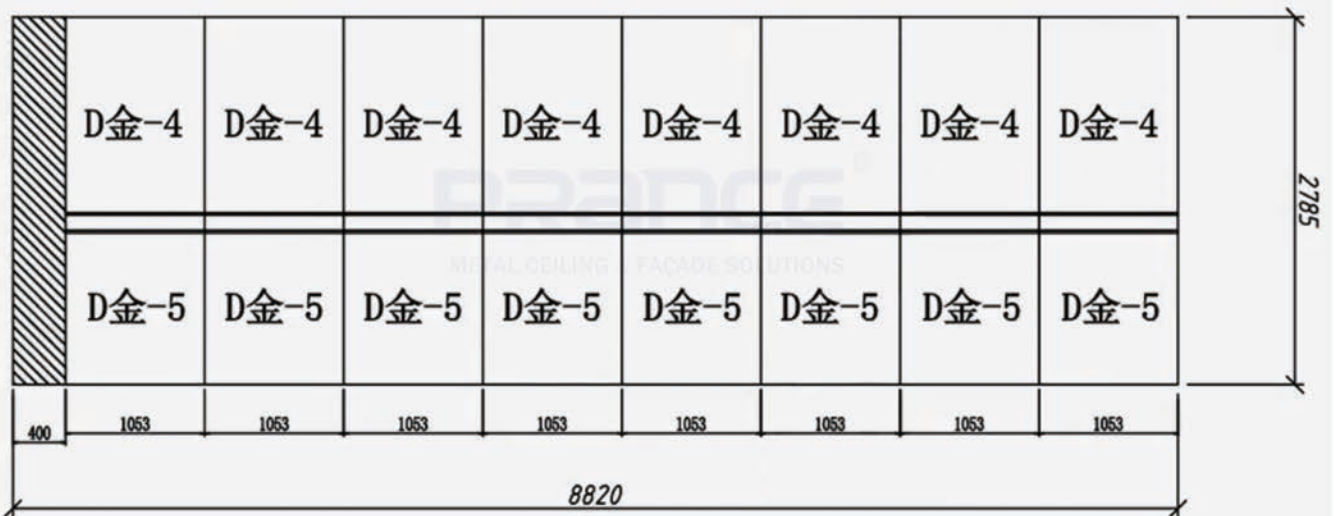

Production Process And Technical Services

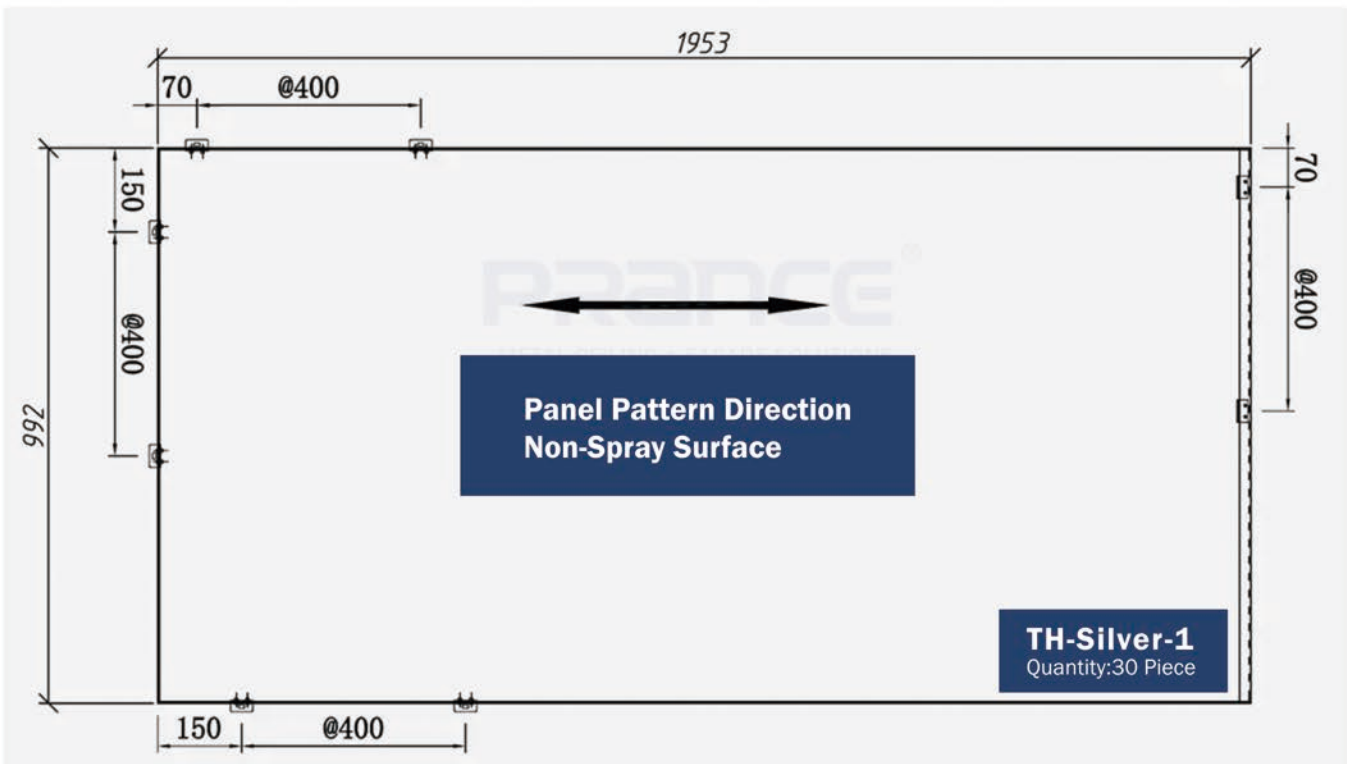
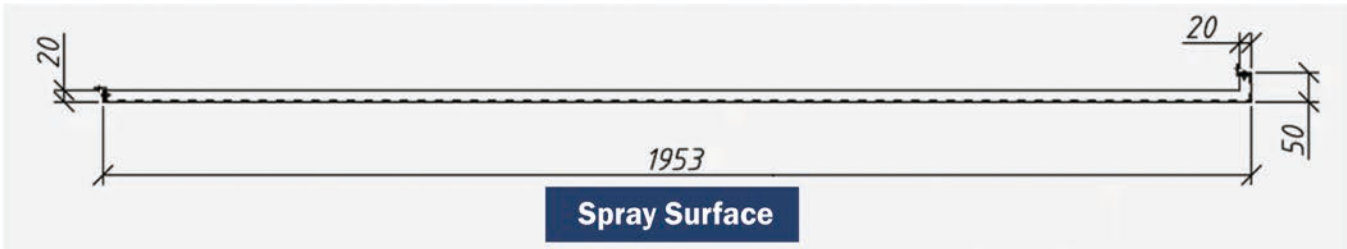
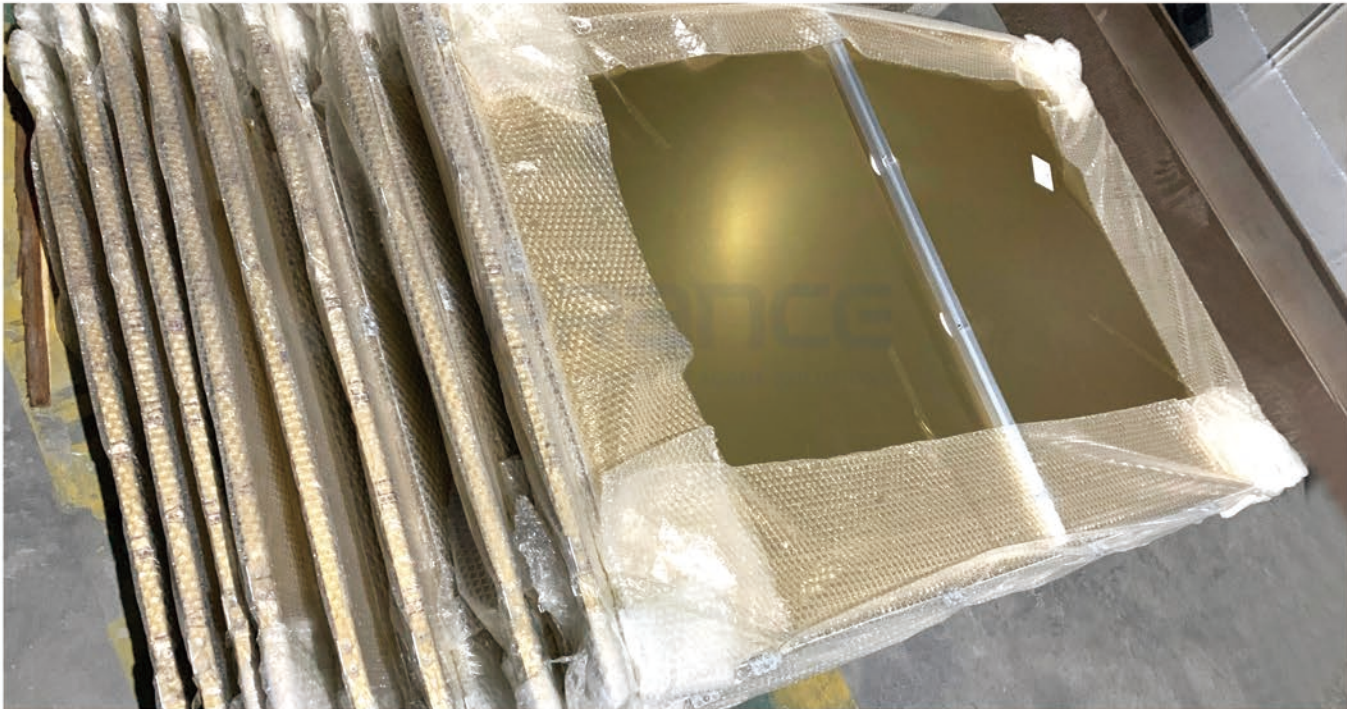





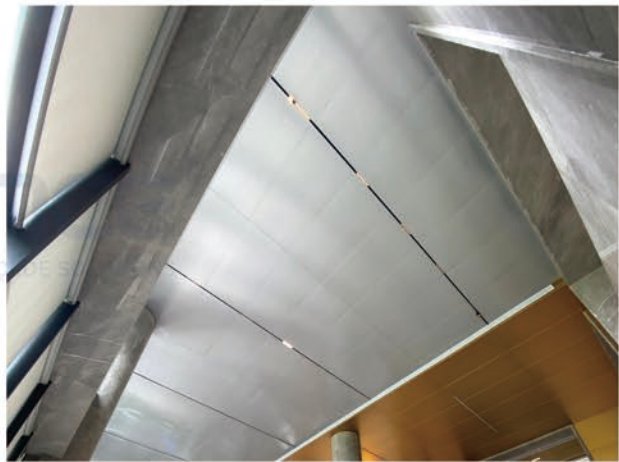

Project Completed





PRANCE METALWORK BUILDING MATERIAL CO.,LTD

Facebook  / LinkedIn  : Prance Metalwork Building Material

Instagram  / YouTube  / Pinterest  : prance_metalwork

Http: [//www.prancebuilding.com](http://www.prancebuilding.com)

Tel: +86-757-83138155

E-Mail: info@prancebuilding.com

Fax: +86-757-83139722

Office: 3F,1st Building,No.11 Gangkou Rd,Chancheng,Foshan,Guangdong.

Factory: 169, South Area, Base of Electrical and Electronic Industry,Baini, Sanshui, Foshan, Guangdong.