

Report Number: MIC-ASI2041608

Audit Date : 30 Nov., 2020

This report is issued by Focus Technology Co., Ltd. (Made-in-China.com) and the supervising inspectorate (Bureau Veritas) to confirm that:

Company Name : Xingdingjiang Packaging Machinery Manufacturing Co., Ltd.
星鼎江包装机械制造(昆山)有限公司
Showroom : <https://xingdingjiang.en.made-in-china.com>
Address : 2F, No. 4 Building, No. 777, Jinmao Road, Luyang, Zhoushi Town,
Kunshan City, Suzhou City, Jiangsu Province, China
Product : Powder Packing Machine

has been on site audited for the Following Scope of Activity

1. General Information
2. Foreign Trade Capacity
3. Product Research & Development Capacity
4. Production Capacity & Quality Control
5. Working Environment
6. Energy Saving and Emission Reduction
7. Photos



General Comments:

Xingdingjiang Packaging Machinery Manufacturing Co., Ltd. is a manufacturer with 23 employees, it was established in 2019, located in 2F, No. 4 Building, No. 777, Jinmao Road, Luyang, Zhoushi Town, Kunshan City, Suzhou City, Jiangsu Province, China. The land occupies an area of 1,400 square meters. The company engaged in the production and sales of powder packing machine.



Sign for and on behalf of
Bureau Veritas

This document is issued by Bureau Veritas. Attention is drawn to the limitation of liability, indemnification and jurisdiction issues defined therein. Any holder of this document shall understand that information contained hereon is solely limited to visual examination of the safety and readily accessible portions of consignment and that the findings at the time of its intervention only and within the limits of Client's instructions, if any. The company's sole responsibility is to its Client. This document does not exonerate parties to a transaction from exercising all their rights and obligations under the transaction document. Any unauthorized use, reproduction, or falsification of the content or appearance of this document is unlawful and offenders may be prosecuted to the fullest extent of the law.

Attention: to check the authenticity of testing/inspection report & certificate, please click: <http://www.bvcerchina.cn/>



SUPPLIER ASSESSMENT REPORT

Audited Company	Xingdingjiang Packaging Machinery Manufacturing Co., Ltd. 星鼎江包装机械制造(昆山)有限公司
Audited Site:	2F, No. 4 Building, No. 777, Jinmao Road, Luyang, Zhoushi Town, Kunshan City, Suzhou City, Jiangsu Province, China

Consigner of Assessment	Made-in-China.com		
Audit Type	<input checked="" type="checkbox"/> Initial Audit <input type="checkbox"/> Re-audit		
Audit Date	30 Nov., 2020	Verify Report	www.bvcerchina.cn
Auditor	Marco Ma	Reviewed by	Joan Hou



CONTENTS

- Part A: General Information**
 - Section 1: Company Overview
 - Section 2: Human Resources
- Part B: Foreign Trade Capacity**
 - Section 1: Export Overall Situation
 - Section 2: Export Business Capacity
 - Section 3: Supplier Management
 - Section 4: After-sales Service Capacity
- Part C: Product Research & Development Capacity**
 - Section 1: Product Research & Development Capacity
- Part D: Management System and Product Certification**
 - Section 1: Management System(s) and Product Certification
- Part E: Production Capacity & Quality Control**
 - Section 1: Production Capacity Section
 - Section 2: Production Process Control
- Part F: Financial Position**
 - Section 1: Financial Data
 - Section 2: Key Performance Indications
 - Section 3: Banking
 - Section 4: Product Insurance
- Part G: Working Environment**
 - Section 1: Working Environment
- Part H: Energy Saving and Emission Reduction**
 - Section 1: Environmental Management
 - Section 2: Water, Gas and Noise Control
- Part I: Industry Information**
 - Section 1: Industry Information
- Part J: Photos**
 - Section 1: Photos of Documents
 - Section 2: Photos of Company

This document is issued by Bureau Veritas. Attention is drawn to the limitation of liability, indemnification and jurisdiction issues defined therein. Any holder of this document shall understand that information contained hereon is solely limited to visual examination of the safety and readily accessible portions of consignment and does not constitute any findings at the time of its intervention only and within the limits of Client's instructions, if any. The company's sole responsibility is to its clients. This certificate does not exonerate parties to a transaction from exercising all their rights and obligations under the transaction document. Any unauthorized use, reproduction, or falsification of the content or appearance of this document is unlawful and offenders may be prosecuted to the fullest extent of the law.

Attention: to check the authenticity of testing/inspection report & certificate, please click: <http://www.bvcerchina.cn/>



Part A: General Information

Section 1: Company Overview

1.1 Legal Validity			
Does the company have a valid business license?	<input checked="" type="checkbox"/> Yes <input type="checkbox"/> No <input type="checkbox"/> Others	Registration Number	91320583MA1XXL8E15
Year of established	21 Feb., 2019	Valid Date	Long Valid
Registered address	2F, No. 4 Building, No. 777, Jinmao Road, Luyang, Zhoushi Town, Kunshan City, Suzhou City, Jiangsu Province, China		
Actual address	2F, No. 4 Building, No. 777, Jinmao Road, Luyang, Zhoushi Town, Kunshan City, Suzhou City, Jiangsu Province, China		
Does the company in abnormal operation status list of industrial and commercial bureau?	No		
Registered capital	5000000 RMB		
Name of legal representative	Ms. Qiaoling Zhang		
Business scope	Packaging machinery and accessories design, production, manufacturing and sales, stainless steel products manufacturing, processing and sales, packaging materials sales, industrial automation machinery and equipment technology development, technology transfer, technical consulting, technical services; intelligent mechanical equipment, mechanical and electrical equipment manufacturing, installation, maintenance (except for special equipment); engaged in the import and export of goods and technology business.		
1.2 Basic Information			
Contact person	Ms. Jolin Zhang		
Phone number	0086-13764550916	Fax number	NIL
URL/Web address	https://xingdingjiang.en.made-in-china.com		
Company type	<input type="checkbox"/> Manufacturer <input type="checkbox"/> Trading Company <input checked="" type="checkbox"/> Combined <input type="checkbox"/> Group Corporation		
Type of ownership	<input checked="" type="checkbox"/> Limited Company <input type="checkbox"/> Public Company <input type="checkbox"/> Foreign joint venture <input type="checkbox"/> State-Owned <input type="checkbox"/> Private Owner <input type="checkbox"/> Wholly foreign-owned enterprises		
Associated company	No associated company		
Products manufactured / sold scope	Powder Packing Machine		
1.3 Company Building Information			
According to:			
<input type="checkbox"/> Land certificate <input type="checkbox"/> Real estate certificate <input type="checkbox"/> Lease agreement <input checked="" type="checkbox"/> Observation Estimated on site			
The company area 1400 square meters The land occupies 1400 square meters. The offices occupy 1200 square meters. The workshops occupy 200 square meters.			



Section 2: Human Resources

2.1 Company Chart

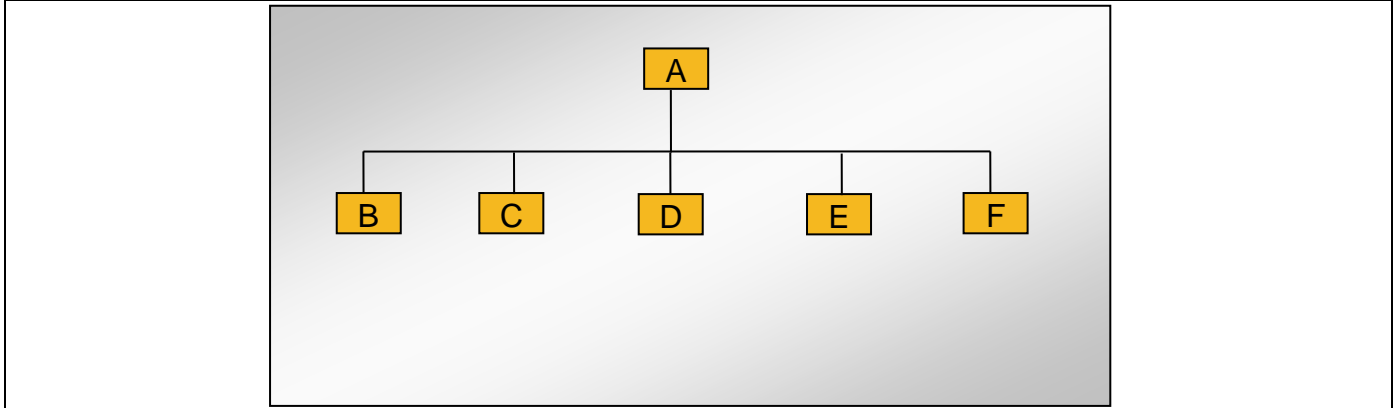

2.2 Explanation of Code and Employee Details

Code	Department	Number of employees
A	General Manager	1
B	Finance Department	1
C	Sales Department	3
D	Technology Department	2
E	Management Department	1
F	Production Department	15
Number in total:		23

2.3 Key Staff

Title	Full name	Education	Working experience for this trade / total experience
Confidential	Confidential	Confidential	Confidential

Remark: Above information of key staff was based on interview with company representative.



Part B: Foreign Trade Capacity

Section 1: Export Overall Situation

1.1 Export Overall Situation	
Does the company have a valid Import and Export license?	<input type="checkbox"/> Yes <input checked="" type="checkbox"/> No
The import and export enterprise code.	NIL
The number of foreign trading staff with relevant trading experience.	<input type="checkbox"/> within 1 year staff <input type="checkbox"/> 1-5 years staff <input checked="" type="checkbox"/> 6-10 years 3 staffs <input type="checkbox"/> over 10 years staff Total 3 staffs
The language freely used by foreign trade staff	<input checked="" type="checkbox"/> English <input type="checkbox"/> others:
Annual revenue of previous year	Confidential
Annual export revenue of previous year	Confidential
Estimated export revenue for this year.	Confidential
Overseas agent / branch	<input type="checkbox"/> Yes <input checked="" type="checkbox"/> No
Nearest port	Shanghai Port
Acceptable quotation terms	<input checked="" type="checkbox"/> FOB <input checked="" type="checkbox"/> CIF <input checked="" type="checkbox"/> CFR
Acceptable payment terms	<input type="checkbox"/> LC <input checked="" type="checkbox"/> T/T <input type="checkbox"/> D/P <input checked="" type="checkbox"/> PayPal <input type="checkbox"/> Western Union <input type="checkbox"/> Small-amount payment
Average lead time (Peak Season)	<input type="checkbox"/> within 15 workday <input checked="" type="checkbox"/> one month <input type="checkbox"/> 2-3 months <input type="checkbox"/> 4-6 months <input type="checkbox"/> 6-12 months <input type="checkbox"/> more time
Average lead time (Off Season)	<input type="checkbox"/> within 15 workday <input checked="" type="checkbox"/> one month <input type="checkbox"/> 2-3 months <input type="checkbox"/> 4-6 months <input type="checkbox"/> 6-12 months <input type="checkbox"/> more time

Section 2: Export Business Capacity

2.1 Market Distribution (please list top three areas)		
Market	Main Product	Main client
<input checked="" type="checkbox"/> North America	Powder Packing Machine	Confidential
<input checked="" type="checkbox"/> South America	Powder Packing Machine	Confidential
<input checked="" type="checkbox"/> Europe	Powder Packing Machine	Confidential
<input checked="" type="checkbox"/> Southeast Asia/ Mideast	Powder Packing Machine	Confidential
<input checked="" type="checkbox"/> East Asia (Japan/ South Korea)	Powder Packing Machine	Confidential
<input checked="" type="checkbox"/> Domestic	Powder Packing Machine	Confidential

This document is issued by Bureau Veritas. Attention is drawn to the limitation of liability, indemnification and jurisdiction issues defined therein. Any holder of this document shall be aware that information contained hereon is solely limited to visual examination of the safety and readily accessible portions of consignment and does not constitute any findings at the time of its intervention only and within the limits of Client's instructions, if any. The company's sole responsibility is to its Client. This document does not exonerate parties to a transaction from exercising all their rights and obligations under the transaction document. Any unauthorized use, reproduction or falsification of the content or appearance of this document is unlawful and offenders may be prosecuted to the fullest extent of the law.

Attention: to check the authenticity of testing/inspection report & certificate, please click: <http://www.bvcerchina.cn/>



Section 3: Supplier Management

3.1 Supplier Management		
Item	Content	Observations /Comments
1	Does the company establish and implement an effective suppliers' assessment procedure?	<input type="checkbox"/> Have the written procedures and followed records <input checked="" type="checkbox"/> Have the written procedures but no records <input type="checkbox"/> Have relevant records without written procedure <input type="checkbox"/> No written procedures or followed records <input type="checkbox"/> Other
2	Does the company have an updated list of approved suppliers?	<input type="checkbox"/> The approved suppliers list was updated in _____ <input type="checkbox"/> Have the written suppliers without approved signature or date. <input checked="" type="checkbox"/> Provided some suppliers names <input type="checkbox"/> No approved suppliers list <input type="checkbox"/> Other

Section 4: After-sales Service Capacity

4.1 After-sales Service Capacity		
Item	Content	Observations /Comments
1	Is there a procedure to conduct random product inspection after final packaging in place?	<input checked="" type="checkbox"/> Have clear standards and written inspection records <input type="checkbox"/> No written standards but had inspection reports <input type="checkbox"/> Have the procedures but no inspection records <input type="checkbox"/> It's not necessary to carry out the inspection <input type="checkbox"/> Other
2	Is there a clear procedure for handling customer complaints?	<input type="checkbox"/> Has the clear procedure and followed records <input checked="" type="checkbox"/> Has the procedure but no written records. <input type="checkbox"/> No written procedures or records. <input type="checkbox"/> Other
3	Can the finished/packaged product be traced by lot identification to the appropriate raw materials test reports?	<input type="checkbox"/> Have the procedures to trace the raw materials. <input checked="" type="checkbox"/> Can trace main materials <input type="checkbox"/> Can trace production date. <input type="checkbox"/> Can't trace products <input type="checkbox"/> Other
4	Are corrective & preventive actions mechanism established and implemented effectively (including the suppliers/ sub-contractors control, incoming inspection, process control, final inspection and customer complaint)?	<input checked="" type="checkbox"/> Has the clear procedure and followed records <input type="checkbox"/> Has the procedure but no written records. <input type="checkbox"/> No written procedures or records. <input type="checkbox"/> Other

This document is issued by Bureau Veritas. Attention is drawn to the limitation of liability, indemnification and jurisdiction issues defined therein. Any holder of this document shall be aware that information contained hereon is solely limited to visual examination of the safety and readily accessible portions of consignment and findings at the time of its intervention only and within the limits of Client's instructions, if any. The company's sole responsibility is to its Client. This document does not exonerate parties to a transaction from exercising all their rights and obligations under the transaction document. Any unauthorized use, reproduction or falsification of the content or appearance of this document is unlawful and offenders may be prosecuted to the fullest extent of the law.

Attention: To check the authenticity of testing/inspection report & certificate, please click: <http://www.bvcerchina.cn/>



Part C: Product Research & Development Capacity

1.1 Product Research & Development Capacity	
The amount of R&D and relevant working experience.	<input type="checkbox"/> within 1year staff <input type="checkbox"/> 1-5 years staff <input checked="" type="checkbox"/> 6-10 years 2 staffs <input type="checkbox"/> over 10 years staff Total 2 engineers
What is the main job responsibility for R&D engineers?	In charge of product of conveyor and new products design and development
Is there any relevant design input, output, review, verification and validation documentation available for auditor to review?	YES The company established R&D control procedure in document. And the relevant records were kept in document.
Is there any special software or instrument used by the R&D staffs during the design process of new products? If yes, please list the main software or instrument.	YES Software: CAD; No Instrument
Does the company have an effective design change control procedure in place?	YES There is in control procedure and the relevant records kept in document.
Please list the patent certificates and qualification license.	NIL







This document is issued by Bureau Veritas. Attention is drawn to the limitation of liability, indemnification and jurisdiction issues defined therein. Any holder of this document shall understand that information contained hereon is solely limited to visual examination of the safety and readily accessible portions of consignment and that the findings at the time of its intervention only and within the limits of Client's instructions, if any. The company's sole responsibility is to its Client. This does not exonerate parties to a transaction from exercising all their rights and obligations under the transaction document. Any unauthorized reproduction, alteration or falsification of the content or appearance of this document is unlawful and offenders may be prosecuted to the fullest extent of the law.

Attention: To check the authenticity of testing/inspection report & certificate, please click: <http://www.bvcerchina.cn/>



Part E: Production Capacity & Quality Control

Section 1: Production Capacity

1.1 Production Workflow Chart					
	→		→		→
Shearing		Bending		Welding	
					
Assembling					
1.2 Products Situation (Top three Product Categories)					
Product	Price range	Min. order quantity	Top monthly output	Average monthly output	Total in 2019
 Powder Packing Machine	Confidential	Confidential	Confidential	Confidential	Confidential
1.3 Main Facilities					
Picture	Facility name	Brand or Country/Region of origin	Target Value/machine*day	Quantity	
	Shearing Machine	China	Confidential	1	
	Bending Machine	China	Confidential	1	

This document is issued by Bureau Veritas. Attention is drawn to the limitation of liability, indemnification and jurisdiction issues defined therein. Any holder of this document shall be aware that information contained hereon is solely limited to visual examination of the safety and readily accessible portions of consignment and does not constitute a warranty or findings at the time of its intervention only and within the limits of Client's instructions, if any. The company's sole responsibility is to its clients. This document does not exonerate parties to a transaction from exercising all their rights and obligations under the transaction document. Any unauthorized reproduction, alteration or falsification of the content or appearance of this document is unlawful and offenders may be prosecuted to the fullest extent of the law.

Attention: to check the authenticity of testing/inspection report & certificate, please click: <http://www.bvcerchina.cn/>





BUREAU
VERITAS

Bureau Veritas No: MIC-ASI2041608



	Welding Machine	China	Confidential	5
--	-----------------	-------	--------------	---

This document is issued by Bureau Veritas. Attention is drawn to the limitation of liability, indemnification and jurisdiction issues defined therein. Any holder of this document shall be aware that information contained hereon is solely limited to visual examination of the safety and readily accessible portions of consignment and does not constitute a warranty or any other form of assurance. The findings at the time of its intervention only and within the limits of Client's instructions, if any. The company's sole responsibility is to its Client. This document does not exonerate parties to a transaction from exercising all their rights and obligations under the transaction document. Any unauthorized use, reproduction, or falsification of the content or appearance of this document is unlawful and offenders may be prosecuted to the fullest extent of the law.

Attention: To check the authenticity of testing/inspection report & certificate, please click: <http://www.bvcerchina.cn/>



Section 2: Production Process Control

2.1 Production Process Control		
Item	Content	Observations /Comments
1	Product R&D capacity	<input type="checkbox"/> Own brand <input checked="" type="checkbox"/> ODM <input checked="" type="checkbox"/> OEM
2	Are the environmental conditions, such as tidiness and cleanliness being controlled and suitable for the operation performed?	<input type="checkbox"/> Very tidy <input checked="" type="checkbox"/> Normal <input type="checkbox"/> Need to improve <input type="checkbox"/> Very poor
3	Are the necessary items /documents provided at appropriate location and under control?	<input checked="" type="checkbox"/> Work Instructions /procedures <input type="checkbox"/> Workmanship standard /acceptance <input type="checkbox"/> Golden sample /Approval sample <input type="checkbox"/> Product picture <input type="checkbox"/> Verbal by workshop director
4	Are written instructions available for incoming material inspections /testing? Is the relevant record maintained?	<input checked="" type="checkbox"/> Has instructions and uniformly followed <input type="checkbox"/> Has instruction but no written records <input type="checkbox"/> Materials checked by storage staff
5	Are written inspections /testing instructions available for finished products? Is the relevant record maintained?	<input checked="" type="checkbox"/> Have instructions and uniformly followed <input type="checkbox"/> Have instruction but no written records <input type="checkbox"/> Finished product checked by packing staff
6	What type of inspection is used for finished products?	<input type="checkbox"/> Random inspection <input type="checkbox"/> Visual inspection <input type="checkbox"/> Function inspection <input checked="" type="checkbox"/> 100% inspection <input checked="" type="checkbox"/> Visual inspection <input checked="" type="checkbox"/> Function inspection
7	Are non-conforming units clearly marked/ segregated to prevent accidental dispatch?	<input checked="" type="checkbox"/> Marked and segregated <input type="checkbox"/> Segregated but not marked clearly <input type="checkbox"/> Not found on site
8	How are the non-conforming units handled?	<input checked="" type="checkbox"/> Repaired and re-inspection <input checked="" type="checkbox"/> Picked out <input type="checkbox"/> Used under control <input type="checkbox"/> Others

This document is issued by Bureau Veritas. Attention is drawn to the limitation of liability, indemnification and jurisdiction issues defined therein. Any holder of this document shall be aware that information contained hereon is solely limited to visual examination of the safety and readily accessible portions of consignment and findings at the time of its intervention only and within the limits of Client's instructions, if any. The company's sole responsibility is to its clients. This document does not exonerate parties to a transaction from exercising all their rights and obligations under the transaction document. Any unauthorized reproduction, alteration or falsification of the content or appearance of this document is unlawful and offenders may be prosecuted to the fullest extent of the law.

Attention: to check the authenticity of testing/inspection report & certificate, please click: <http://www.bvcerchina.cn/>



Part G: Working Environment

Section 1: Working Environment

1.1 Welfare Benefits		
Item	Content	Observations /Comments
1	Does the company have effective procedures to verify the age of staff at the time of recruitment?	<input checked="" type="checkbox"/> Has written procedure and keeps adequate age documents of workers <input type="checkbox"/> Has written procedure but doesn't follow records <input type="checkbox"/> Hasn't written procedure or follows records
2	Do all workers sign employment contracts with the factory?	<input checked="" type="checkbox"/> All workers sign employment contracts <input type="checkbox"/> Some workers sign employment contracts <input type="checkbox"/> Only management staff sign employment contracts <input type="checkbox"/> No staff sign employment contracts
3	Is statutory contribution required for all employees' social insurance (e.g. health insurance, unemployment insurance, accident insurance etc.) paid for by the enterprise?	<input checked="" type="checkbox"/> All workers have social insurance. <input type="checkbox"/> Some workers have social insurance <input type="checkbox"/> Only management staffs have social insurance <input type="checkbox"/> No staff have social insurance
4	Does the company have a clear and effective policy on working hours, rest and vacations? If does, please list it.	<input checked="" type="checkbox"/> All staffs work kept to the policy <input type="checkbox"/> Most of the time it keeps to the policy except midseason. <input type="checkbox"/> Usually needs overtime. <input type="checkbox"/> No relevant records for working hours Describe the working hours: 8:00am-12:00am, 13:00pm-17:00pm
5	Does the company pay extra remunerations for all overtime work?	<input checked="" type="checkbox"/> For all overtime work. <input type="checkbox"/> For official holidays <input type="checkbox"/> For official holidays except weekend. <input type="checkbox"/> No extra remunerations for overtime.
6	Does the company have dormitories for staff? If yes, please describe the condition.	<input type="checkbox"/> Provide dormitories for all staff <input type="checkbox"/> Provide dormitories for workers <input type="checkbox"/> Provide dormitories for management staff <input checked="" type="checkbox"/> No dormitories were provided. Describe the condition: There is no one need it.
1.2 Labor Protection		
Item	Content	Observations /Comments
1	Are there uniforms for all staff in company?	<input checked="" type="checkbox"/> Yes <input type="checkbox"/> No <input type="checkbox"/> Other
2	Is the emergency medical supplies enough and easily used in workshop?	<input checked="" type="checkbox"/> Yes <input type="checkbox"/> No <input type="checkbox"/> Other
3	Does the company arrange health and safety training for new workers?	<input checked="" type="checkbox"/> Yes <input type="checkbox"/> No <input type="checkbox"/> Other
4	Do the workers have the appropriate protective equipment during operation in workshop? Such as gloves, masks.	<input checked="" type="checkbox"/> Yes <input type="checkbox"/> No <input type="checkbox"/> Other

This document is issued by Bureau Veritas. Attention is drawn to the limitation of liability, indemnification and jurisdiction issues defined therein. Any holder of this document shall be aware that information contained hereon is solely limited to visual examination of the safety and readily accessible portions of consignment and findings at the time of its intervention only and within the limits of Client's instructions, if any. The company's sole responsibility is to its clients. This certificate does not exonerate parties to a transaction from exercising all their rights and obligations under the transaction document. Any unauthorized use, reproduction, or falsification of the content or appearance of this document is unlawful and offenders may be prosecuted to the fullest extent of the law.

Attention: To check the authenticity of testing/inspection report & certificate, please click: <http://www.bvcerchina.cn/>





5	Is there training needed and carried out for fire protection?	<input checked="" type="checkbox"/> Yes <input type="checkbox"/> No <input type="checkbox"/> Other
---	---	--

This document is issued by Bureau Veritas. Attention is drawn to the limitation of liability, indemnification and jurisdiction issues defined therein. Any holder of this document shall be aware that information contained hereon is solely limited to visual examination of the safety and readily accessible portions of consignment and packaging and does not include any other findings at the time of its intervention only and within the limits of Client's instructions, if any. The company's sole responsibility is to its Client. This document does not exonerate parties to a transaction from exercising all their rights and obligations under the transaction document. Any unauthorized use, reproduction, or falsification of the content or appearance of this document is unlawful and offenders may be prosecuted to the fullest extent of the law.

Attention: To check the authenticity of testing/inspection report & certificate, please click: <http://www.bvcerchina.cn/>



Part H: Energy Saving and Emission Reduction

Section 1: Environmental Management

1.1 Environmental Management		
Item	Content	Observations /Comments
1	Environmental Management System	<input type="checkbox"/> ISO 14001 Certificate <input type="checkbox"/> Cleaner production management <input checked="" type="checkbox"/> NIL
2	Environmental Impact Assessment	<input type="checkbox"/> The Report of Environmental impact assessment is approved by EPA . <input checked="" type="checkbox"/> NIL
3	Check and Acceptance of Completed Constructive Projects	<input type="checkbox"/> The Report Completed Constructive Projects Inspection and Acceptance is approved. <input checked="" type="checkbox"/> NIL
4	"Three Simultaneity" for Environmental protection	<input type="checkbox"/> The Report of "Three Simultaneity" for Environmental protection Inspection and Acceptance is available. <input checked="" type="checkbox"/> NIL

Section 2: Water, Gas and Noise Control

2.1 Water, Gas and Noise Control		
Item	Content	Observations /Comments
1	Water-intaking	<input type="checkbox"/> Water-intaking license <input type="checkbox"/> No water-intaking license <input checked="" type="checkbox"/> No water taken from natural water body
2	Waste water	<input type="checkbox"/> Water-draining license or contract <input checked="" type="checkbox"/> Having carried out waste water treatment before draining <input type="checkbox"/> Having carried out waste water monitoring and the result of which being within the standard limit <input type="checkbox"/> No detail activities were found
3	Emission to air	<input type="checkbox"/> Air pollutant emission license <input checked="" type="checkbox"/> Having carried out air pollutant emission monitoring and the result of which being within the standard limit <input type="checkbox"/> No detail activities were found to reduce emission to air
4	Classification and Recycling for solid waste	<input type="checkbox"/> Having applied trash classification recycling <input checked="" type="checkbox"/> Having special warehouse for hazardous waste <input type="checkbox"/> No detail activities were found
5	Noise	<input type="checkbox"/> The company carried out noise monitoring and the result of which being within the standard limit one time per year <input checked="" type="checkbox"/> No detail activities were found

This document is issued by Bureau Veritas. Attention is drawn to the limitation of liability, indemnification and jurisdiction issues defined therein. Any holder of this document shall understand that information contained hereon is solely limited to visual examination of the safety and readily accessible portions of consignment and findings at the time of its intervention only and within the limits of Client's instructions, if any. The company's sole responsibility is to its clients. This certificate does not exonerate parties to a transaction from exercising all their rights and obligations under the transaction document. Any unauthorized reproduction, alteration or falsification of the content or appearance of this document is unlawful and offenders may be prosecuted to the fullest extent of the law.

Attention: To check the authenticity of testing/inspection report & certificate, please click: <http://www.bvcerchina.cn/>



Part J: Photos

Section 1: Photos of Documents

1.1 Photos of Documents

Description: Business License, Tax Registration Certificate, Organization Code Certificate



This document is provided by Bureau Veritas. Attention is drawn to the limitation of liability, indemnification and jurisdiction issues defined therein. Any holder of this document that information contained hereon is solely limited to visual examination of the safety and readily accessible portions of consignment and its condition at the time of its intervention only and within the limits of Client's instructions, if any. The company's sole responsibility is to its client. This does not exonerate parties to a transaction from exercising all their rights and obligations under the transaction document. Any unauthorized reproduction or falsification of the content or appearance of this document is unlawful and offenders may be prosecuted to the fullest extent of the law.

Attention: To check the authenticity of testing/inspection report & certificate, please click: <http://www.bvcerchina.cn/>



Section 2: Photos of Company

2.1 Photos of Company and Product Sample

Description: Company Gate



Description: Office



Description: Workshop



Description: Workshop



Description: Product Sample



Description: Product Sample



-- End of the Report --

This document is issued by Bureau Veritas. Attention is drawn to the limitation of liability, indemnification and jurisdiction issues defined therein. Any holder of this document shall be aware that information contained hereon is solely limited to visual examination of the safety and readily accessible portions of consignment and does not constitute any findings at the time of its intervention only and within the limits of Client's instructions, if any. The company's sole responsibility is to its clients. This certificate does not exonerate parties to a transaction from exercising all their rights and obligations under the transaction document. Any unauthorized reproduction, alteration or falsification of the content or appearance of this document is unlawful and offenders may be prosecuted to the fullest extent of the law.

Attention: To check the authenticity of testing/inspection report & certificate, please click: <http://www.bvcerchina.cn/>

