

## US Serise Specification Sheet

Model	US-360	US-400	US-550	US-600
Capacity	357L/12.6cuft	410L/14.5cuft	550L/19.4cuft	580L/20.5cuft
Net / Gross Weight	75 / 78	79 / 84	90 / 95	93 / 99
Unit size(mm)	560×610×1985	625×610×1985	685×740×1985	765×695×1985
Package size (mm)	610×655×2010	675×655×2010	730×785×2010	815×740×2010
Loading Qty (20/40HQ)	27 / 54 / 76	27 / 54 / 71	23 / 47 / 47	21 / 44 / 44
Gas	R290			
CoolingType	Dynamic cooling (no frost)			
ShelfQTY	Wire, 4 pieces			
Inside Temperature	0 ~ 10 °C (32 ~ 50 °F)			
Power	220V 50/60Hz, 110V 60Hz			
Temperature Control	Digital controller			
Climate Class	N~ST			
Glass Door	Double glazing glass door, with front safety glass, With self-closing door			
LED Light	Vertical LED light for inside glass door and horizontal LED light for canopy			
Customized	Branding Sticker Additional Shelf Black Interior etc.			

**Sticker Template**  
Sides



**Light-box**

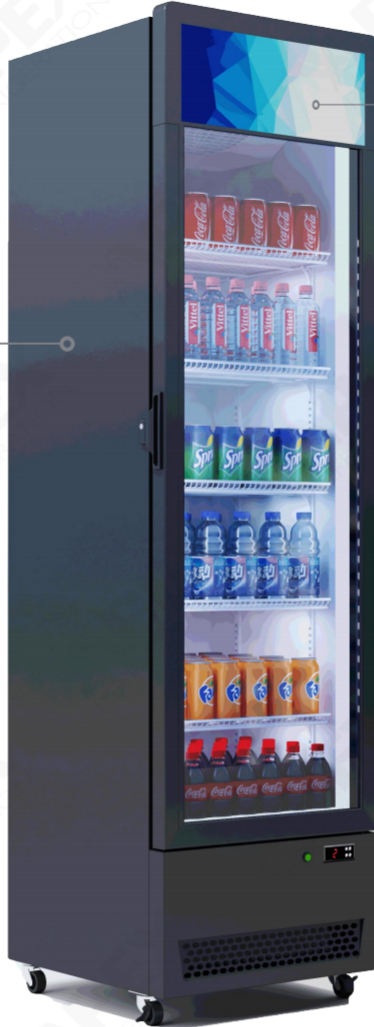
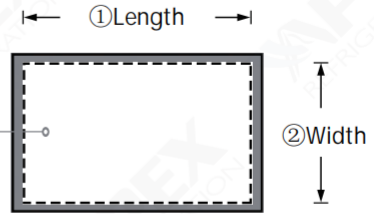

Model		US-360	US-400	US-550	US-600
<b>Light Box</b>	①Length (mm)	460	525	585	665
	②Width (mm)	192	192	192	192
<b>Sides</b>	③Length (mm)	530	530	660	615
	④Width (mm)	1905	1905	1905	1905

- Colours: CMYK or PANTONE. Please specify the PANTONE No. if there is any.
- Resolution: 300 DPI.Formats:Photoshop,ILLustrator in original created version including layers.
- Please create high-resolution design in Total dimensions,without bleed difference.
- Please don't place any important elements in any invisible areas.

# US-360 Drawing

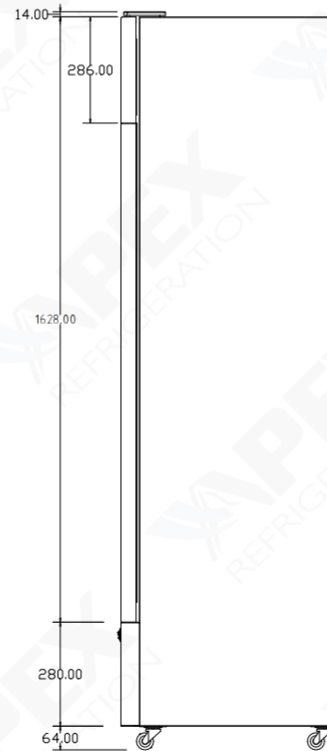
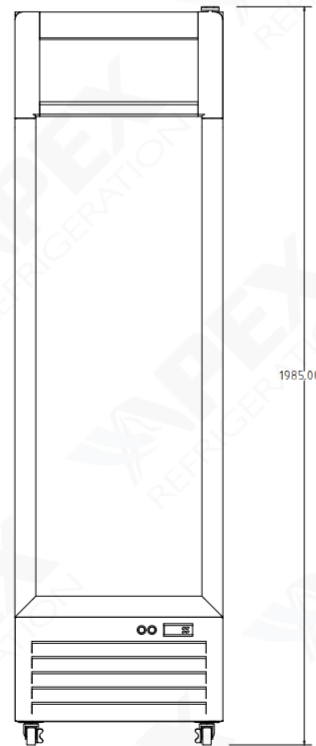
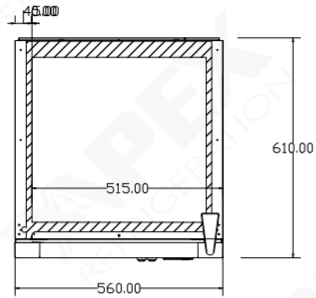

US-360 Drawing

Unit Dimension (W×D×H)	560×610×1985mm
Package Dimension (W×D×H)	610×655×2010mm
	www.apexcool.com info@apexcool.com

# US-400 Drawing

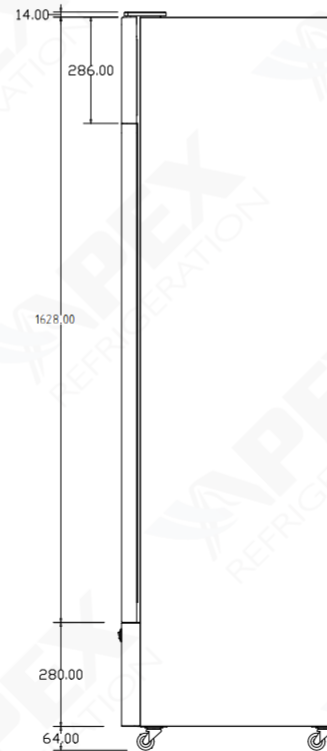
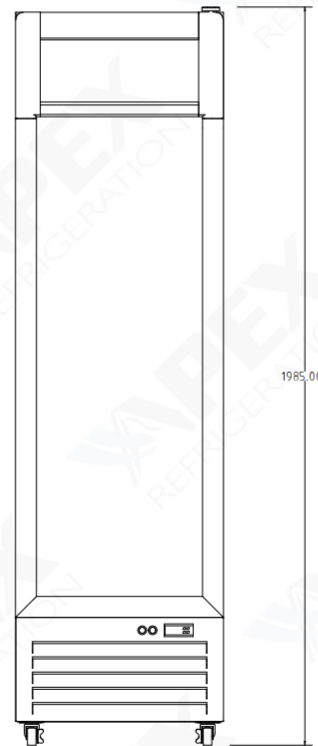
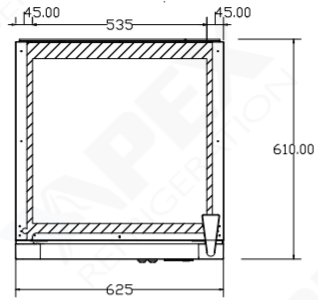



## US-400 Drawing

Unit Dimension (W×D×H)	625×610×1985mm
Package Dimension (W×D×H)	675×655×2010mm
	<a href="http://www.apexcool.com">www.apexcool.com</a> <a href="mailto:info@apexcool.com">info@apexcool.com</a>

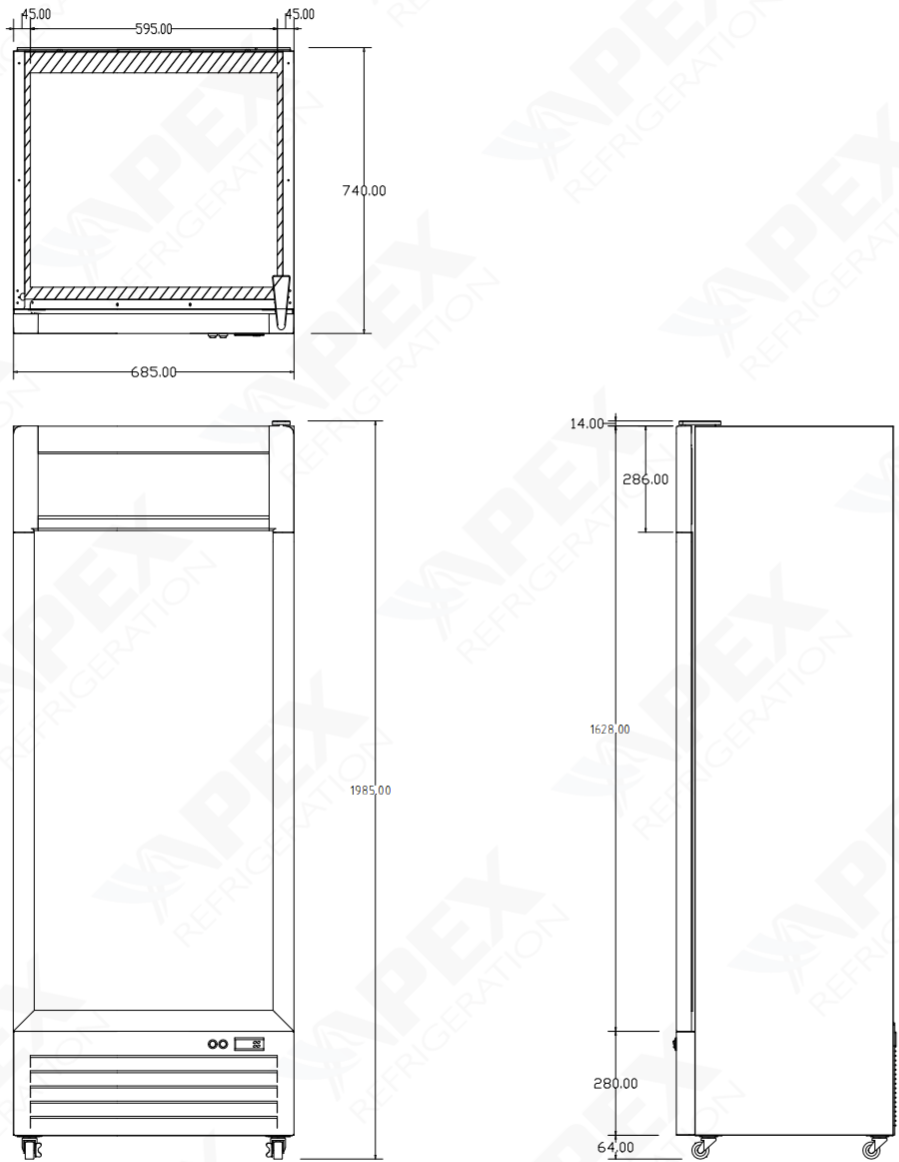
# US-550 Drawing



US-550 Drawing

Unit Dimension (W×D×H)	685×740×1985mm
Package Dimension (W×D×H)	730×785×2010mm
 	<a href="http://www.apexcool.com">www.apexcool.com</a> <a href="mailto:info@apexcool.com">info@apexcool.com</a>

# UUS-600 Drawing

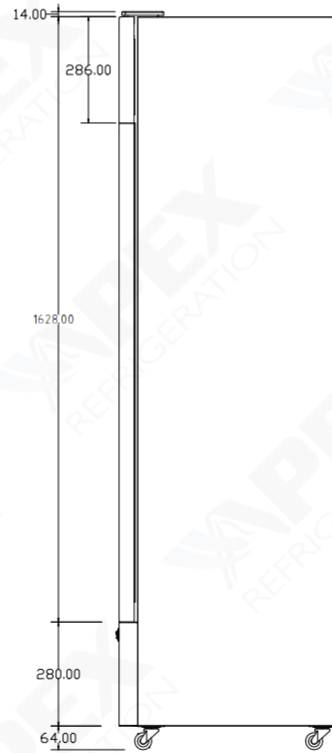
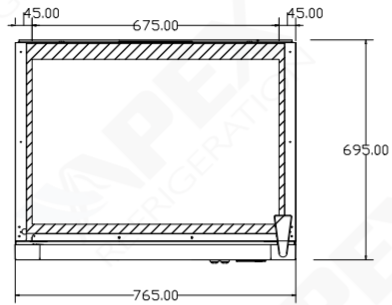

US-600 Drawing

Unit Dimension (W×D×H)	765×695×1985mm
Package Dimension (W×D×H)	815×740×2010mm
	<a href="http://www.apexcool.com">www.apexcool.com</a> <a href="mailto:info@apexcool.com">info@apexcool.com</a>



# INSTRUCTION MANUAL

---

## UPRIGHT DISPLAY COOLER

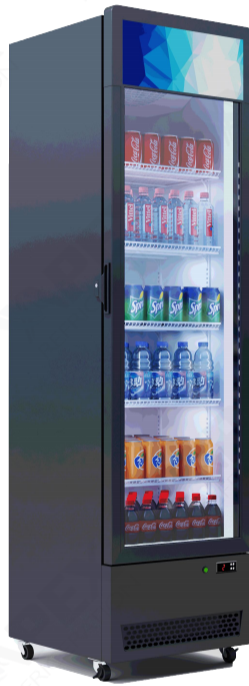

### CONTENTS

● SAFETY PRECAUTIONS	-----	1 ~ 3
● HOW TO USE	-----	4 ~ 5
● CLEANING	-----	5
● IN CASE OF THE FOLLOWING	-----	-6
● BEFORE REQUESTING SERVICE	-----	-7

Please read these instructions completely before operating the units.

# SAFETY PRECAUTIONS

- To ensure proper use, please thoroughly study these SAFETY PRECAUTIONS before operating the Unit.
- The purpose of the safety precautions in this manual is to ensure safe and correct use of the unit to minimize risks that could cause serious damage and injury to you or other persons. The safety precautions are divided into WARNINGS and CAUTIONS. Cases where improper handling of the unit could lead to death or serious injury are listed under the "⚠️WARNING" heading. However, the cases listed under the "⚠️CAUTION" heading could also lead to serious results. To ensure the safety, adhere strictly to both types of safety precautions.
- Keep ventilation openings, in the appliance enclosure or in the built-in structure, clear of obstruction.
- This appliance is not intended for use by persons (including children) with reduced physical, sensory or mental capabilities, or lack of experience and knowledge, unless they have been given supervision or instruction concerning use of the appliance by a person responsible for their safety.
- Children should be supervised to ensure that they do not play with the appliance.
- Do not use mechanical devices or other means to accelerate the defrosting process, other than those recommended by the manufacturer.
- Do not damage the refrigerant circuit.
- This appliance can be used by children aged from 8 years and above and persons with reduced physical, sensory or mental capabilities or lack of experience and knowledge if they have been given supervision or instruction concerning use of the appliance in a safe way and understand the hazards involved. Children shall not play with the appliance. Cleaning and user maintenance shall not be made by children without supervision.
- If the supply cord is damaged, it must be replaced by the manufacturer, its service agent or similarly qualified persons in order to avoid a hazard.
- Do not store explosive substances such as aerosol cans with a flammable propellant in this appliance.
- When disposing of the appliance, do so only at an authorized waste disposal centre. Do not expose to flame.
- Warning: The lamp must not be replaced by the user! If the lamp is damaged, contact the customer helpline for assistance.
- The A-weighted emission sound pressure level is below 70 dB(A)
- The appliance shall be disconnected from its power source during cleaning or maintenance and when replacing parts.



**WARNING** Improper handling of the unit could lead to death or serious injury.



**CAUTION** Improper handling of the unit could lead to serious results depending on the circumstances.

- Text set off by the exclamation mark  contains information that should be strictly adhered to.
- After reading the instruction manual, store it in an easily accessible place where the user(s) of this product can easily find it.

## ◆ PRECAUTIONS FOR INSTALLATION

### ⚠️ WARNING



Installation should be performed only by the dealer or a qualified expert. Attempting to install the unit yourself could result in water leakage, refrigerant leakage, electrical shock, or fire.

## ◆ PRECAUTIONS FOR USE

### ⚠️ WARNING



DONT TAMPER

All repairs, disassembly and modifications should be performed only by qualified technicians. Attempting to perform these yourself could result in a fire, malfunction, and injury.



ELECTRICAL SHOCK HAZARDS

Never splash water directly onto the product or wash with water as short-circuit and electrical leakage could result.

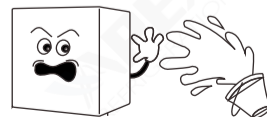



# SAFETY PRECAUTIONS

## ! WARNING



Never put flammable or volatile substances into the unit as explosion and fire could result.

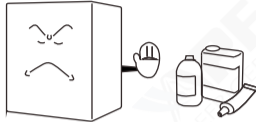

Do not damage, modify, excessively bend, strain, twist or bundle up the power cord. Also, placing heavy objects on the power cord or squeezing it in a tight place could damage it, possibly resulting in electrical shock or fire.



Use a dedicated wall outlet. Do not use extension cords or convenience receptacles as this could result in electrical shock, overheating and a fire.

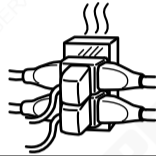

Never use flammable spray cans or leave flammable substances near the unit. Sparks from electrical switches could result in explosion and fire.

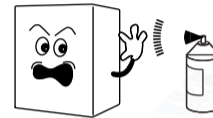

The cooler is intended for storage and display of beverages for sale. Do not use for other purpose than intended as this could adversely affect items placed in the unit.

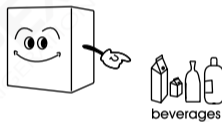

Never attempt to insert fingers, sticks, etc. into the cold air suction outlet as a circulation fan is rotating at high speed inside the outlet. Injury, electrical shock and improper operation could result.



For indoor use only. Using the unit in a location exposed to rain could result in electrical leakage and electrical shock.



Never place heavy objects or items containing water on top of the unit. Objects could fall down and cause injury and spilled water could deteriorate the insulation of electrical components and result in electrical leakage.



Install the unit in a location where the floor is sturdy enough to support the load of the unit. If the floor is not sturdy enough or installation is incorrectly performed, the unit could tip over and falling shelves and products could cause personal injury.

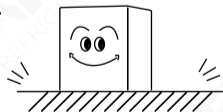

If you find gas leakage, please don't touch the chest freezer, and close gas and open the door for ventilation. Gas leakage could cause explosion, fire, and fire injury.

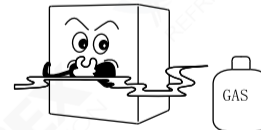

Store the unit in a location where it is not exposed to rain. Using a unit that has been exposed to rain could result in electrical leakage and electrical shock.



Keep away from hot air sources. Cooling performance is reduced if the unit is placed near heat sources such as hot plates and stoves and if it is exposed to direct sunlight.



# SAFETY PRECAUTIONS

## ! WARNING



Leave disassembly and disposal of the unit to qualified experts.



Should the unit need temporary storage, make sure not to store the unit in a location where children play and take precautions so that the door cannot be completely closed. This will minimize the risk that a child becomes trapped inside the compartment.

### WELL VENTILATED PLACE

Please make sure there is more than 10cm space between UPRIGHT COOLER and the wall. If there is no space, cooling capacity can drop down.

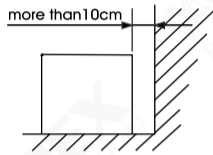

If installation in a damp location is unavoidable, also install an electrical leakage circuit breaker. If no electrical leakage circuit breaker is installed, electrical shock could result.

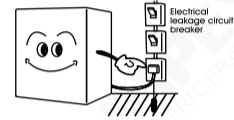

PROHIBITED

Never hang from the door or climb onto the unit. The unit could tip over or fall and cause material damage or injury.

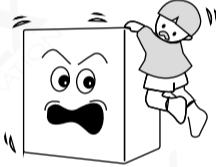

DISCONNECT POWER CORD PLUG FROM WALL OUTLET

Disconnect the power cord plug from the wall outlet before moving the unit and make sure that the power cord is not damaged during transport. A damaged power cord could result in electrical shock and/or fire.

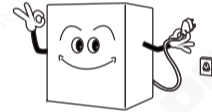

DONT PINCH FINGERS

Grasp the handle when closing the door. Holding at other positions could result in pinched fingers and injury.



Do not touch

Do not push hand against or apply excessive force to glass surfaces as the glass could break and cause injury.



When disconnecting the power cord plug from the wall outlet, hold at the plug main body close to the outlet. Pulling the cord could cause wire breakage, possibly resulting in overheating and fire.

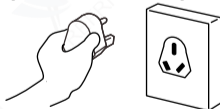

Make sure that the unit does not tip over or fall when it is moved. A falling unit could cause serious injury.

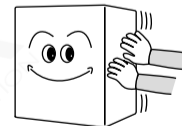

PROHIBITED

Do not throw items onto the shelves and do not place items totaling more than 25 kg on each shelf. The shelf could fall down, possibly causing injury.



Be sure to attach and secure shelves correctly. An improperly attached shelf could fall down and cause injury.



# HOW TO USE

## BEFORE USE

- Remove shipping package, tape, etc, and leave doors open ventilate for a while.
- The unit is cleaned before shipment. However, clean the compartment interior after delivery.
- Please insert power supply plug into the wall outlet ,single-phase to cat voltage.
- Allow the unit to operate for about 1 hour to cool the compartment before placing items in the cooler.

## WAIT 5 MINUTES OR MORE BEFORE RE-STARTING

- Restarting the unit immediately after it has been turned off may cause fuses to blow and activate the circuit-breaker, the compressor may be overloaded, and/or other damage may occur.

## TEMPERATURE ADJUSTMENT



The electronic controller has been factory set to cool the beverages to lowest temperature approximately 1-5 Centigrade. Should you wish to alter the temperature set point, please adopt the following procedure.

### ● User parameter setting

In the status of temperature measuring and controlling, press **Set** key for three seconds to enter user parameter setting state, it displays menu St in the digital tube. At this time, press **Set** key to display the corresponding parameter value, and press **▲** or **▼** to adjust the set temperature, and then press **Set** key to return to menu item St.

### ● Enter to the administrator menu setting

In the state of user menu setting, when it displays menu item St in the digital tube, press **▲** to switch to the menu item Po, press **Set** key to display 00, and press **▲** and **▼** to adjust it to 55, then press **Set** key again to return to menu item Po. At this time, press **▲** key to display rd, indicating that it has entered to the administrator parameter setting status. If it doesn't adjust to 55, press **Set** key to return to menu time Po, then press the key **▲**, it will exit from user parameter setting status and return to the temperature measuring and control status.

### ● Administrator parameter setting

After enter to the administrator parameter setting, press **▲** and **▼** to select menu items (St、Po、rd.....) ; After select the item, press **Set** key to enter to the current parameter setting, press **▲** and **▼** to adjust parameters, and then press **Set** key to return to the menu item.



# HOW TO USE

## DRAIN TRAY

- Defrosting is performed automatically and drain water is collected in the drain tray.
- Water in the drain tray is evaporated automatically. In humidity, there is a large amount of water in the drain tray, so please throw away drain water once a day.

## EFFICIENT USE

- To prevent cold air from escaping, open and close the door quickly and keep the door opened for as short a time as possible.
- Please install the unit in the place which is well-ventilated.

## SHELF HEIGHT ADJUSTMENT

The shelf height can be adjusted.

Arrange the shelves in accordance with the dimensions of the items to be placed in the cooler.

## PLACING ITEMS IN THE SHOWCASE

This showcase employs a forced circulation of cold air system. If circulation of cold air is obstructed, the items will not be adequately refrigerated. Pay attention to the following points:

- Do not let items obstruct the cold air inlet and suction outlet.
  - Place items so that they do not protrude from the shelves. The gap between the shelves and the door is used for circulation of cold air.
  - Place items evenly on all shelves.
- Please do not display goods on the bottom. Please put goods on the shelf.  
Commercial refrigeration display cooler.

## CLIMATE CLASS

- 32°C±2°C on appliances of climatic class 0, 1, 2, 3, 4, 6 or 8
- 43°C±2°C on appliances of climatic class 5 or 7

INSTRUCTION MANUAL

# CLEANING



WARNING

To prevent any electrical shock hazards or injury by rotating circulation fan, always disconnect the power cord plug from the wall outlet before cleaning.

## 1 EXTERIOR AND COOLER COMPARTMENT

Wipe with a soft, dry cloth. If very soiled, wipe with a cloth that has been moistened with a detergent. Then wipe with a cloth that has been dipped in water.



WARNING

WARNING: Do not splash water directly onto the cooler and do not wash with water. Short-circuit and electrical shock could result.

- Clean the cooler regularly to keep it clean at all times.
- Never use polishing powder, soap powder, benzine, oil or hot water as these will damage the painting and plastic components.

## 2 CHECKS

To ensure the safety, perform the following checks after cleaning.

- Is the power cord plug firmly inserted into a dedicated wall outlet? Confirm that the plug is not abnormally hot.
- Check the power cord for cracks and damage. Should the slightest irregularity be observed, contact the dealer from whom you purchased this unit or our customer's service.

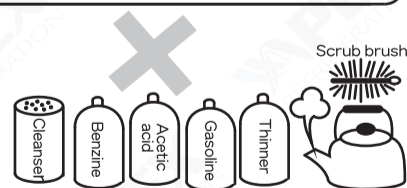

# IN CASE OF THE FOLLOWING

---

## 1 POWER FAILURE

Keep opening and closing of the door to a minimum.  
Avoid placing new items in the cooler as this will raise the temperature inside the compartment.

## 2 WHEN NOT USED FOR A LONG PERIOD

Remove all items from the compartment and disconnect the power cord plug from the wall outlet.  
Clean the compartment interior and wipe away all water.  
To prevent mold formation and bad smell, leave the door open to dry the compartment completely.

## 3 TRANSPORTATION

Disconnect the power cord plug from the wall outlet.  
When moving the cooler, make sure that the feet do not damage the power cord.  
Do not let the feet hit against floor steps, thresholds, etc.

## 4 TEMPORARY STORAGE

Affix a piece of wood, etc. Between the door and main unit to prevent complete closing of the door.  
Make sure not to store the unused cooler at a location where children play.  
Should a child enter the compartment and the door is closed, the child may not be able to open the door from the inside.

INSTRUCTION MANUAL

# BEFORE REQUESTING SERVICE

---

Please check the following items if you encounter problems with the unit. If the problem continues after taking the proper remedial actions, disconnect the power cord plug from the wall outlet.  
Transfer the items stored in the cooler to a box or other container. Then contact the dealer from whom you purchased this unit and be ready to provide information as listed in "REQUIRED INFORMATION" below.



CAUTION

To prevent any electrical shock hazards, do not disconnect the power cord plug from the wall outlet with wet hands.

# BEFORE REQUESTING SERVICE

No refrigeration at all	<ul style="list-style-type: none"><li>● Is the power supply interrupted?</li><li>● Is the power cord plug disconnected from the wall outlet?</li><li>● Are the shop's power fuses blown and/or the circuit breaker activated?</li></ul>
Inadequate refrigeration	<ul style="list-style-type: none"><li>● Is the temperature setting appropriate?</li><li>● Are items obstructing the cold air inlet and suction outlet?</li><li>● Are stored items packed too tight?</li><li>● Is the door open or is it opened and closed frequently?</li><li>● Is the condenser clogged?</li></ul>
Excessive noise	<ul style="list-style-type: none"><li>● Are all feet in firm contact with the floor?</li><li>● Is the rear panel of the cooler contacting the wall or other objects?</li><li>● Are other objects in contact with the cooler?</li></ul>
Condensation on cooler exterior	<ul style="list-style-type: none"><li>● Condensation may condense on the exterior and door during hot and humid days or depending on the place of installation. This occurs when the humidity is high and water particles in the air contact cold surfaces. This is normal. wipe away condensation with a dry cloth.</li></ul>

Showcase sometimes stop running when thermostat turns off.

## INSTRUCTION MANUAL

# REQUIRED INFORMATION

- ① Nature of malfunction (as accurately as possible)
  - ② Product number
  - ③ Serial number
  - ④ Customer's name, address, phone number
  - ⑤ Year and date of purchase
  - ⑥ Desired date for service visit
- } ON RATING LABEL  
ON CARTON