

ALUMINIUM SHUTTERS
OUTDOOR SHADING SOLUTIONS PROVIDER

PRODUCT INTRODUCTION

Aluminium shutters are modern indoor and outdoor energy-saving sunshade product that perfectly combine with practicality, protection and decoration function.

- ◆ **Aluminium 6063, a green building material**, which comply with policy of carbon peaking and neutrality , supporting the development of green buildings;
- ◆ **Fixed and Operable Blade Options.** Operable blade can provide variable control of light and ventilation. When the blades are opening to 90 degrees, the best ventilation is obtained.
- ◆ **The airfoil double-layer blades improve bending strength**, ensuring that the aluminium shutters have little deformation when impacted by external force, and achieve protection function.
- ◆ The ratio of visible & direct sunlight transmittance and UV transmittance all are 0.
Blocks out UV and sunlight transmission.



FUNCTION DIAGRAM

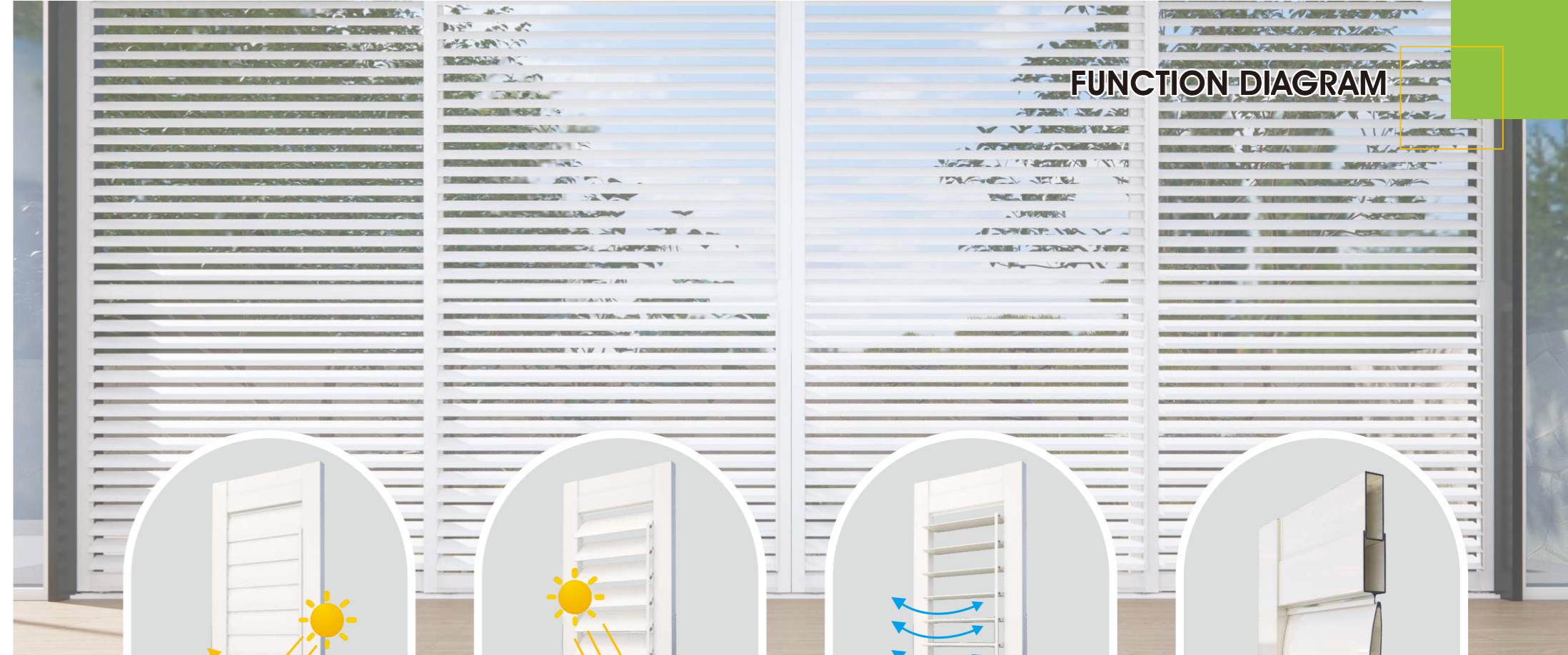

All aluminum alloy 6063 material;
Shading and heat insulation.

Operable blade;
Opening and closing 0°~180°;
Dimming by refraction.

When blades opening to 90°;
Ventilation rate up to 80%;
Create good ventilation condition.

Airfoil double-layer blades;
Made by aluminium 6063
Durable;
Anti collision and theft.

APPLICATION



Louvered Pergola

Aluminium louvered pergola matched with aluminium shutters, to create the comprehensive all-weather sunshade leisure space.



Without Shutters



With Bi-folding Shutters

APPLICATION

Without Shutters

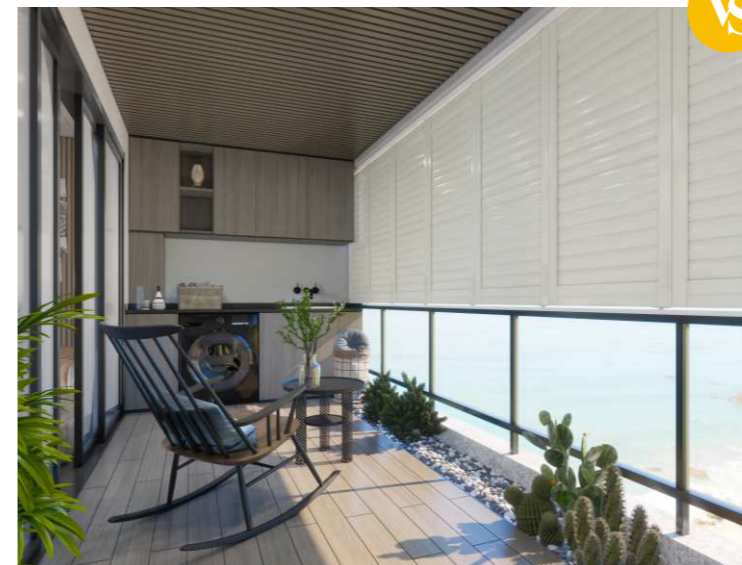
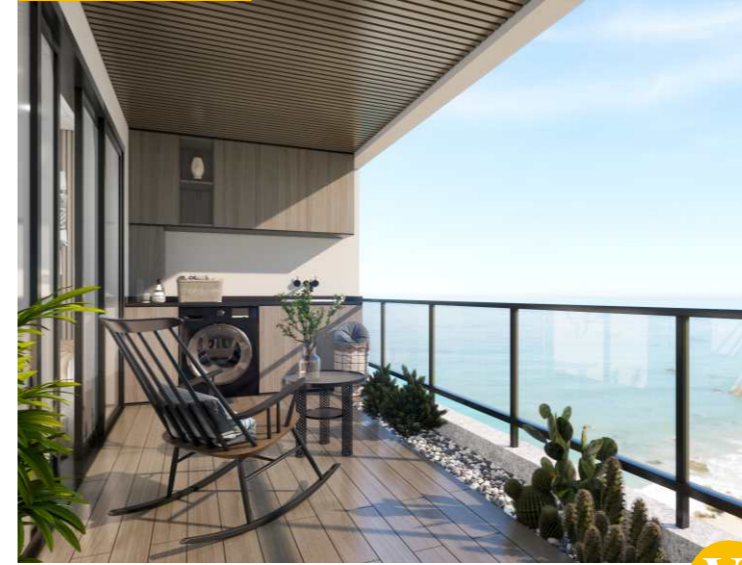

With Bi-folding Shutters



Balcony

Due to the changeable weather and no shelding, the balcony utilization rate is quite low. Aluminium shutters can provide flexiable shelding. By providing practicality that without affecting the view of outdoor scenery.

APPLICATION

Room Divider

Sliding or bi-folding aluminium shutters can use as moveable room divider. Free conversion between large and small space. Solve the problem of wall opacity and glass excessive light transmission. Can achieve divider, protection, shading, dimming, ventilation, privacy and beauty function at the same time.



Without Shutters



With Sliding Shutters & Bi-folding Shutters

APPLICATION

High-end Private Club

Aluminium shutters are equipped with high-quality coating powder. The high-quality products are contributed to atmosphere creation.

Without Shutters



VS



With Fixed Shutters



APPLICATION



Terrace Area Extending From The Building

As the medium of indoor and outdoor environment, it perfectly connects the building and outdoor space.



Without Shutters



VS



With BI-folding Shutters

APPLICATION

High-class Office Building

The simple, high-end interior design and the comfort of light adjustment are not only a reflection of taste, but also conducive to the improvement of work concentration.



Without Shutters

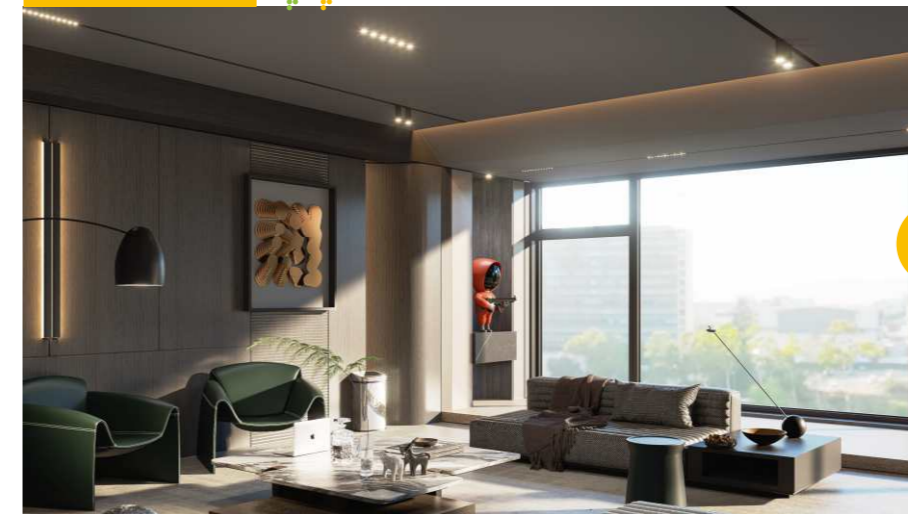

VS



With BI-folding Shutters

Building facade

Aluminium shutters can install inside or outside of the glass facade. Replace the traditional shading products, with lower maitainace cost, higher safety & flexiability, and stronger aesthetics.



Without Shutters



VS

With Fixed Shutters



PRODUCT STYLE AND APPLICATION CASES

• Fixed Shutters •

Single panel dimension: 400mm-1350mm
Standard configuration: U-channel mount

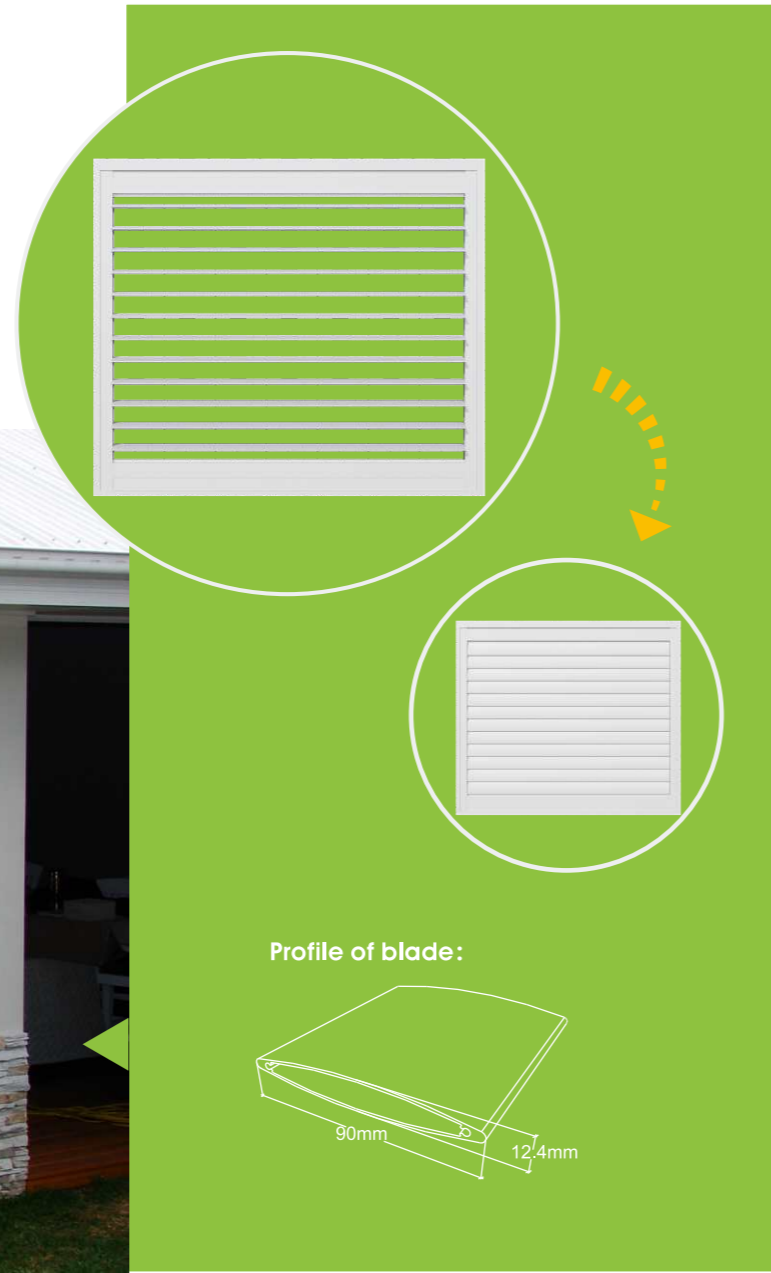

PRODUCT STYLE AND APPLICATION CASES



A Panel

B Top & bottom U-channel

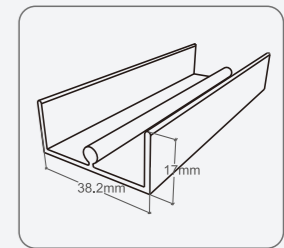
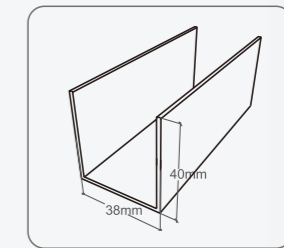

C Left & right U-channel

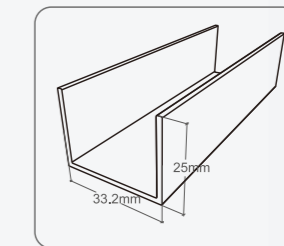

D H-channel

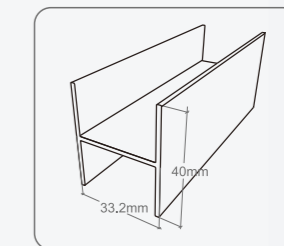

PRODUCT STYLE AND APPLICATION CASES

• Sliding Shutters •

Single panel dimension: 400mm-1350mm
 Number of tracks: Single, double, triple or others
 Standard configuration: Rolling sliding system
 Optional Accessory: Stainless steel flush bolt



Profile of blade:

90mm 12.4mm

PRODUCT STYLE AND APPLICATION CASES

Bottom rolling sliding system

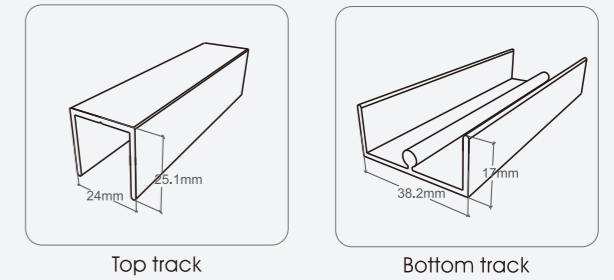

Top rolling sliding system

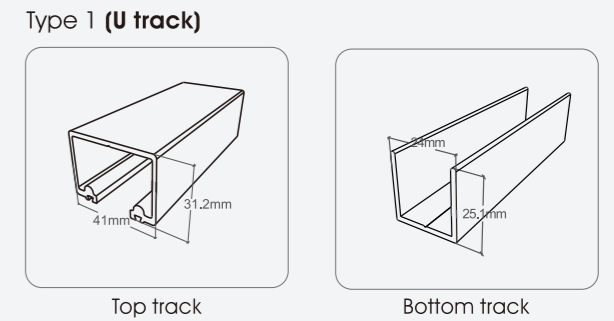

Type 2 (M track)

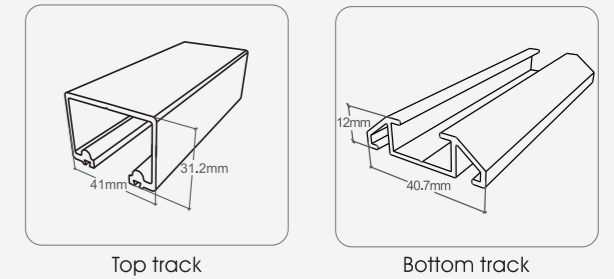

A Panel

B Top and bottom rail

Options of quantity of tracks and panels

- Single track & panel
- Single track & double panels
- Double tracks & panels
- Triple tracks & panels

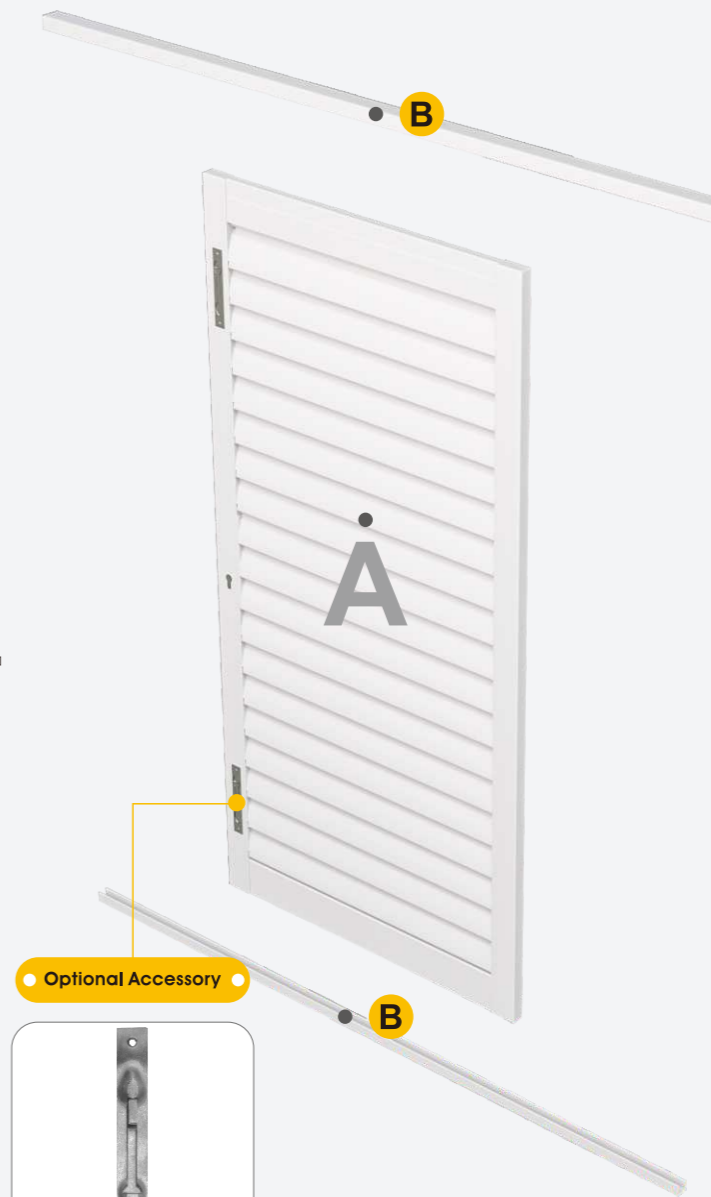

• Optional Accessory •

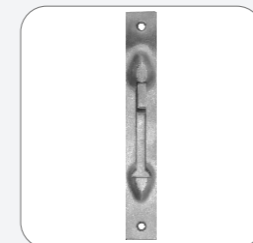

Stainless steel flush bolt

PRODUCT STYLE AND APPLICATION CASES



• Bi-folding Shutters •

Single panel dimension: 400mm-1350mm

Folding direction: All folded to one side / folded from the middle to both sides / special requirements.

Standard configuration: Aluminum hinge, pivot set, carrier system

Optional Accessory: Stainless steel flush bolt, stainless steel hinge

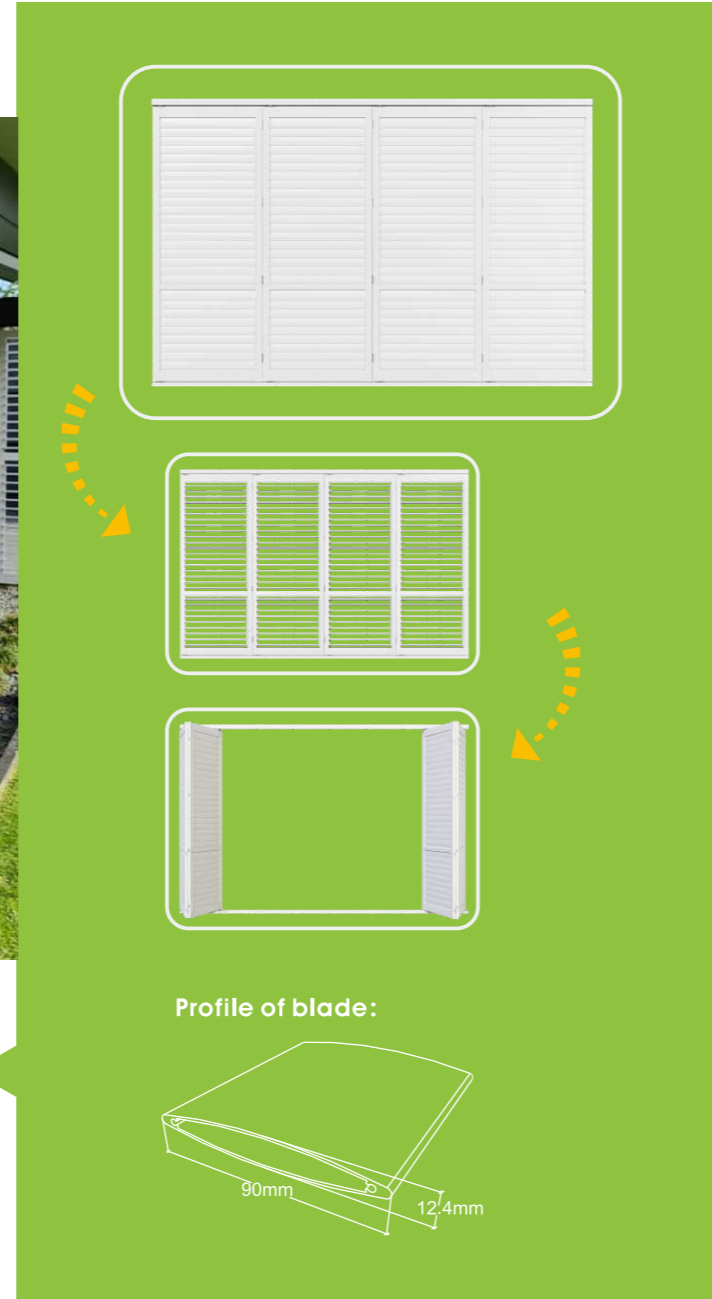

PRODUCT STYLE AND APPLICATION CASES

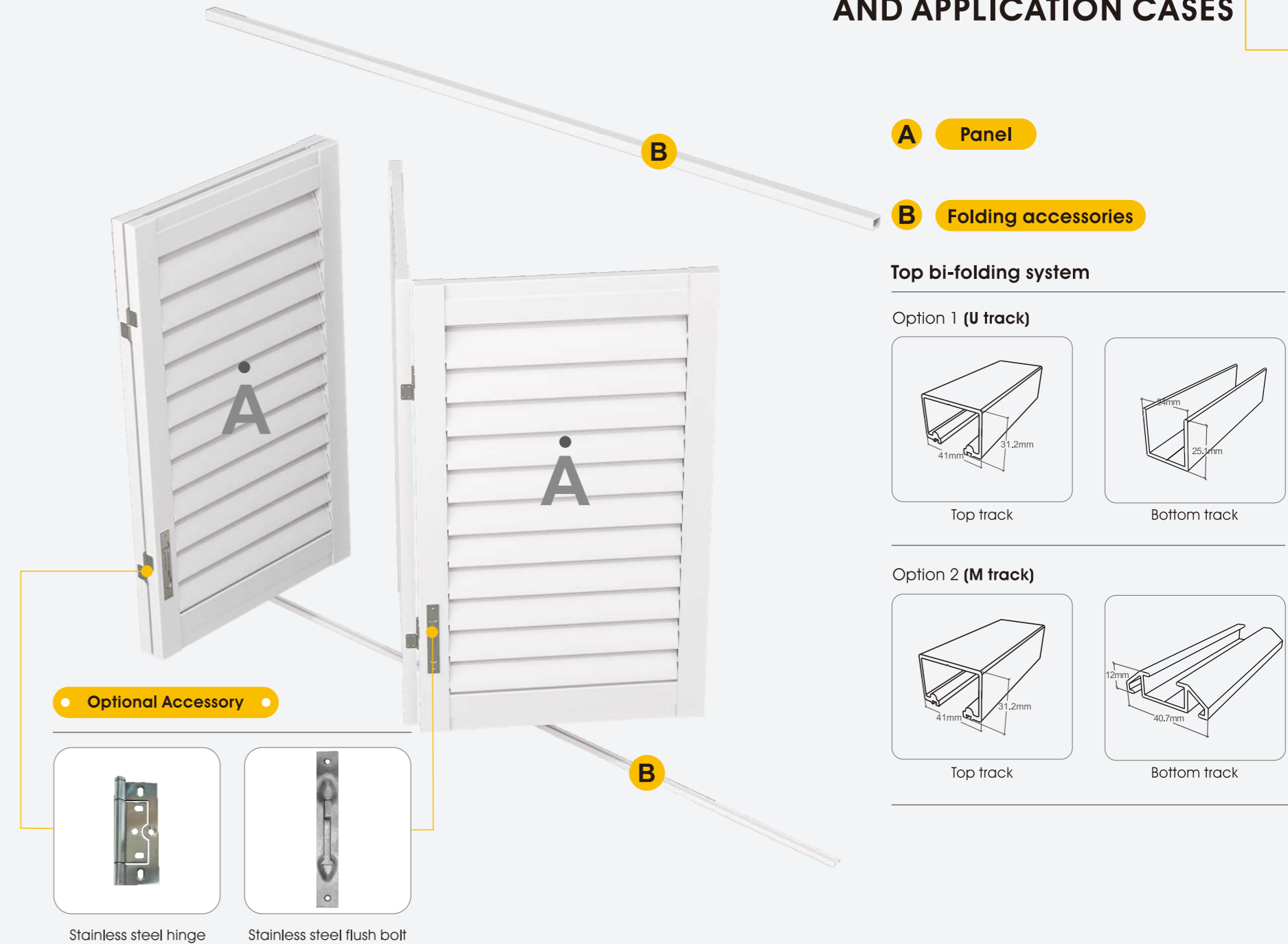

PRODUCT STYLE AND APPLICATION CASES



• Hinged shutters •

Single panel dimension: 400mm-800mm

Optional Accessory: Stainless steel handle lock, stainless steel hinge

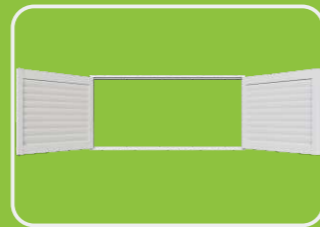
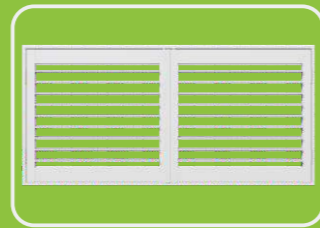

Profile of blade:

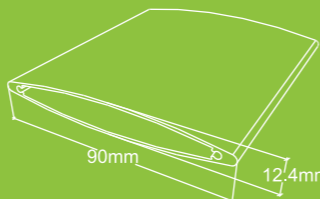

PRODUCT STYLE AND APPLICATION CASES

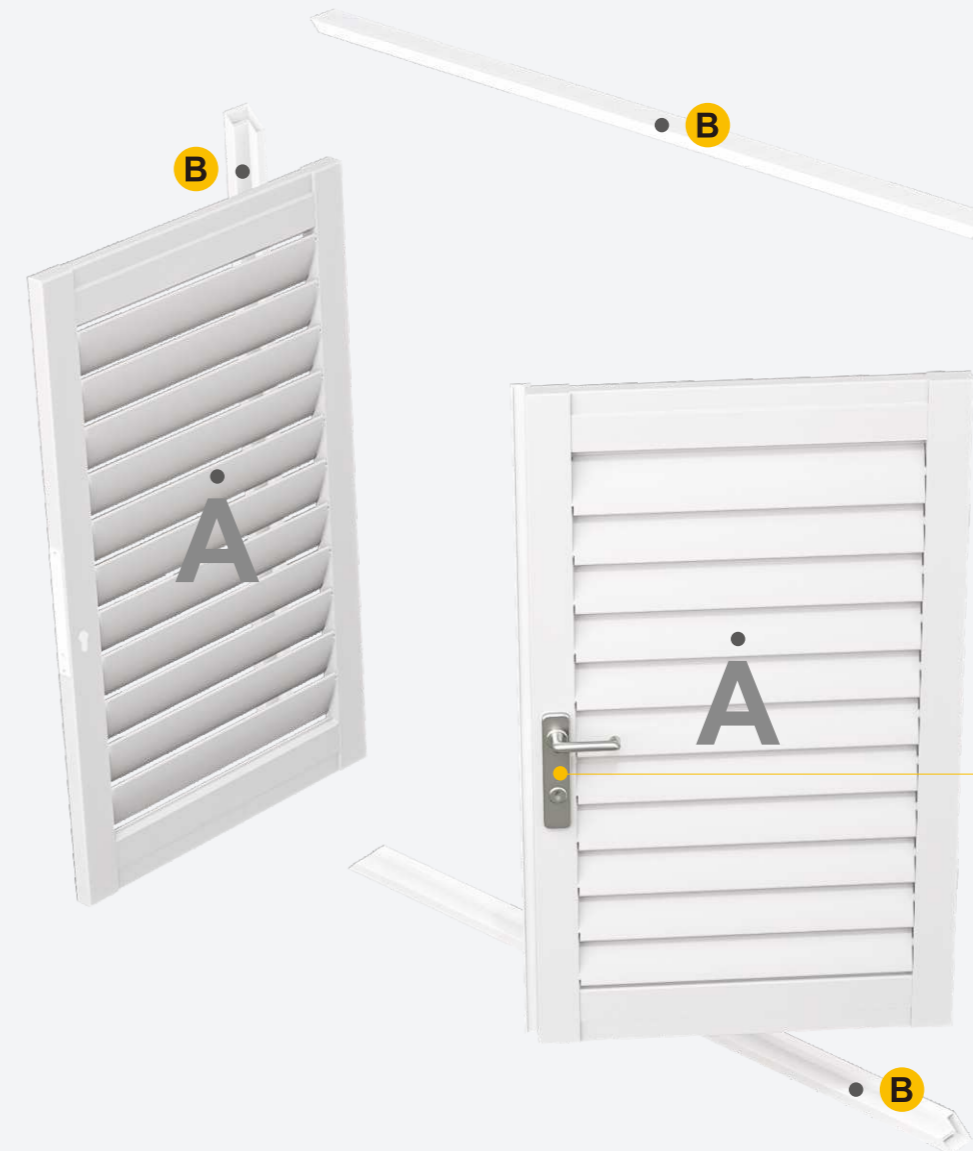

A Panel

B Frame

Option 1 (L frame)

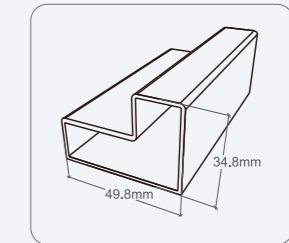

Option 2 (z frame)

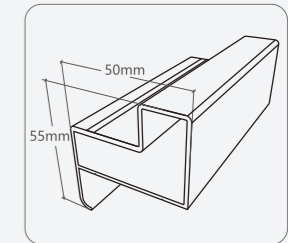

• Optional Accessory •



Stainless steel handle lock



Stainless steel hinge

STANDARD COLOUR

Surface treatment warranty of 10 years

Powder coating surface treatment



Gloss White
YFS11002

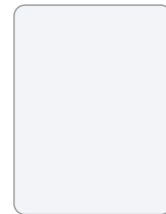

Matte White
YFS13001



Silver Gray
YFS03001

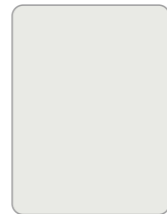

Light Gray
YFC32021



Dark Gray
YFC32020



Matte Black
YFC80004

Wood Grain Color



OAK
YFCM0068N

The color is for reference only, please prevail in kind.

*** Remarks:** If used with our pergola, the color of the shutters can be consistent with the standard color of pergola.

MEASUREMENT

▼ **Measuring method: top/middle/bottom, left/middle/right points**
(measuring H1, H2, H3, W1, W2, W3, total of 6 sizes)



*** Remarks:** For installation in the opening, select the minimum value of width and height;
For installation outside the opening, select the maximum value of width and height;
If it is not square, it is best to contact our company to provide a solution.





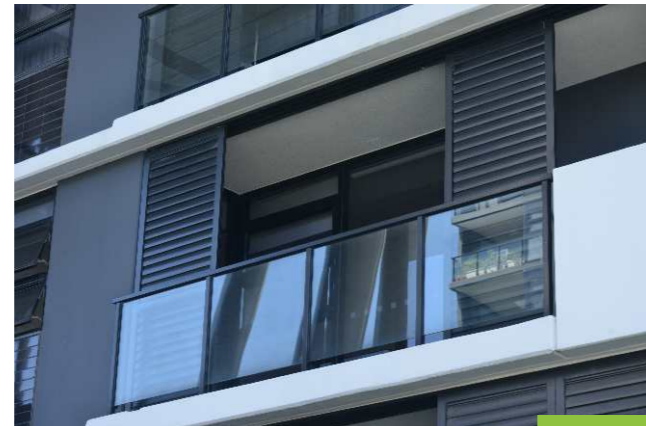

Project Name: Arena Buliding
 Completed: 2014
 Location: Queensland, Australia
 Application: Apartment Building
 Floor Number: 12



Project Name: East Quarter Sydney
 Completed: 2016
 Location: Queensland, Australia
 Application: Apartment Building
 Floor Number: 10