

PE-700 series

Portable Power Station

User Manual

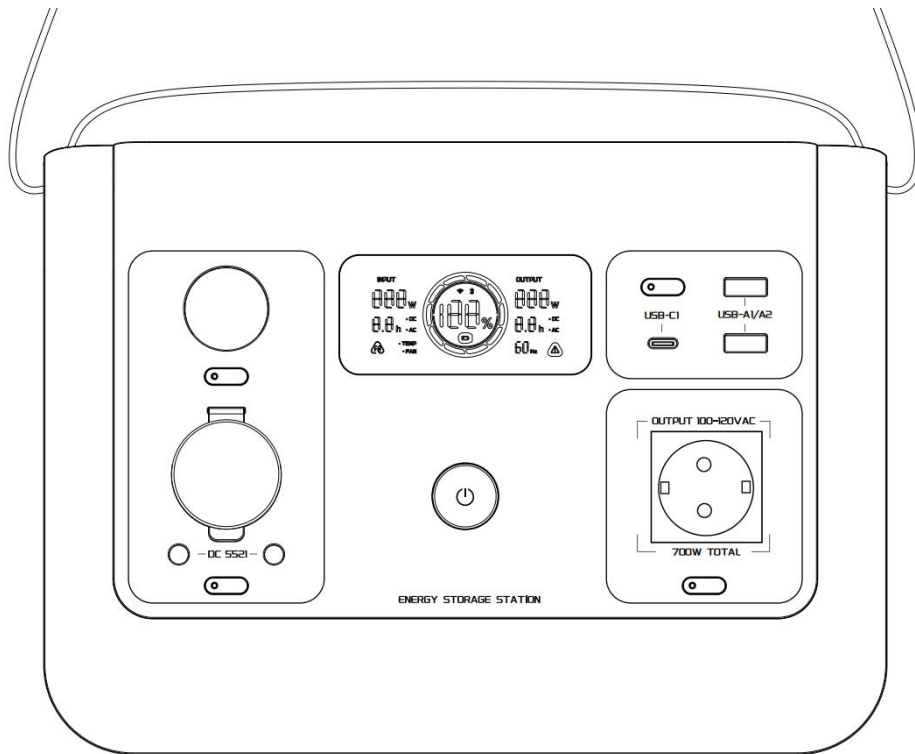

Please read this manual before use and follow its guidance.
Keep this manual for future reference.

CONTENTS

1. Declaration	1
2. Important Safety Instructions	1
2.1 Usage	1
2.2 Disposal Guide	3
3. What's In the Box	3
4. Getting Started	3
4.1 Product Introduction	4
4.2 Product Features	4
4.3 Product Specifications	4
4.4 Product Overview	6
4.5 Product LCD Screen	7
4.6 Product Power ON/OFF	8
4.7 LED Light	8
4.8 Charge Your Device	9
4.9 Recharge Your Power Station	10
4.10 EPS (Emergency Power Supply)	12
4.11 Estimated Usage Time	13
5. FAQ (Frequently Asked Questions)	14
6. Storage and Maintenance	15
7. Troubleshooting	15
8. FCC Warning	17

1. Declaration

1. Please read this ENTIRE User Manual carefully before using the product to ensure that you completely understand the product and can correctly use it. After reading this user manual, keep it properly for future reference. Improper use of this product may cause serious injury to yourself or others, or cause product damage and property loss. Once you use this product, it is deemed that you understand, approve and accept all the terms and content in this document. SOSEN INNOVATION is not liable for any loss caused by the user's failure to use this product in compliance with this User Manual.
2. In compliance with laws and regulations, SOSEN INNOVATION reserves the right to final interpretation of this document and all documents related to this product. This document is subject to changes (revisions, updates, or termination) without prior notice. Please visit SOSEN Innovation's official website to obtain the latest product information.

2. Important Safety Instructions

2.1 Usage

1. **Before using this product, please be sure to read ENTIRE User Manual and check all materials. If the equipment is damaged, cracked, electric leakage, AC disconnection and other abnormal conditions, please stop using it immediately.**
2. Do not use the product near a heat source, such as a fire source or a heating furnace.
3. Avoid contact with any liquid. Do not immerse the product in water or get it wet. Do not use the product in rain or humid environments.
4. Do not use the product in an environment with strong static electricity/magnetic fields.
5. Do not disassemble the product in any way or pierce the product with sharp objects.
6. Avoid using wires or other metal objects that may result in a short circuit.
7. Do not use unofficial components or accessories. If you need to replace any components or accessories, please visit official SOSEN INNOVATION channels to check relevant information.
8. Do not stack any heavy objects on top of the product.
9. Do not lock the fan forcibly during use or place the product in an unventilated or dusty area.

10. When using the product, please strictly follow the operating environment temperature specified in this User Manual. If the temperature is too high, it may result in a fire or explosion; if the temperature is too low, the product performance may be severely reduced, or the product may cease to work.
11. Please avoid impact, falls, or severe vibrations when using the product. In case of a severe external impact, turn off the power supply immediately and stop using the product. Ensure the product is well fastened during transportation to avoid vibrations and impacts.
12. If you accidentally drop the product into water during use, please place it in a safe open area, and stay away from it until it is completely dry. The dried product should not be used again and should be properly disposed of according to Section 2.2 below. If the product catches fire, we recommend that you use the fire extinguishers in the following order: water or water mist, sand, fire blanket, dry powder, and finally a carbon dioxide fire extinguisher.
13. Use a dry cloth to clean off dirt on the product ports.
14. Rest the product on a flat surface to avoid damages caused by the product falling over. If the product is overturned and severely damaged, turn it off immediately, place the battery in an open area, keep it away from combustible matter and people, and dispose of it in accordance with local laws and regulations.
15. **Ensure that product is kept out of reach of children and pets when no adult around.**
16. **Store the product in a clean, dry and ventilated place.**
17. It is recommended to use moisture barrier bags in wet environments (for example, places by the sea or waterways) to prevent the product from getting soaked. If water is found inside the product, it must not be used or turned on again. Please take anti-electric shock measures before touching the product. Following this, place the product in a safe, waterproof and open area. Once complete, contact SOSEN INNOVATION Customer Service immediately.
18. This product is not recommended for powering medical emergency equipment related to personal safety, including but not limited to medical grade ventilators (hospital version CPAP: Continuous Positive Airway Pressure), artificial lungs (ECMO) Extracorporeal Membrane Please follow your doctor's instructions and consult with the manufacturer for restrictions on the use of the equipment if used for general medical equipment, please be sure to monitor the power status to ensure that the power does not run out.
19. When in use, power supply products will generate electromagnetic fields, which are likely to affect the normal operation of medical implants or personal medical equipment such as pacemakers, cochlear implants, hearing aids, defibrillators etc. If these types of medical equipment are being used, please contact the manufacturer to inquire about any restrictions on the use of such equipment. These measures are fundamental to ensure a safe distance between the medical implants(for example, pacemakers, cochlear implants, hearing aids, defibrillators etc.) and this product while in use.

20. When the power supply is connected in normal mode to a refrigerator, power fluctuations may cause the power supply to automatically shut down. When connecting the power supply to a refrigerator that stores medicine, vaccines or other valuable items, it is recommended to set the AC output to "Always on" in the app. This helps support a continuous power supply and ensures a safe and efficient power consumption state.

2.2 Disposal Guide

1. If conditions permit, make sure that the battery is fully discharged before disposing it in a designated battery recycling bin. The product contains batteries with potentially dangerous chemicals, so it is strictly prohibited to dispose of it in ordinary trash cans. For more details, please follow the local laws and regulations on battery recycling and disposal.
2. If the battery cannot be fully discharged due to a product failure, please do not dispose of the battery directly in the battery recycling box. In such case, you should contact a professional battery recycling company for further processing.
3. Please dispose of over-discharged batteries that cannot be recharged.

3. What's In the Box

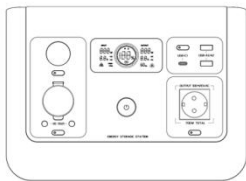

Portable Power Station

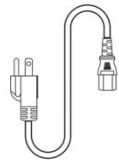

AC Recharging Cable

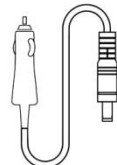

Car Recharging Cable

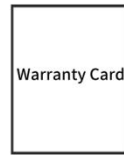

Warranty Card



User Manual

4. Get Started

4.1 Product Introduction

This product is our company's latest research and development of PE-700 series portable power station, born in the ultimate innovation and mature technology. The company follows the national industry certification standards. Equipped with 700W power inverter and 307Wh lithium iron phosphate battery pack, it generate pure sine wave AC output. It also supports ECO mode, where AC output or DC output automatically turns off in low power discharging or no load to save capacity discharging. The product design is ergonomic, and the lifting is more labor-saving. Overall, this product is the best choice of portable power station, to meet your emergency backup and outdoor needs as much as possible.

4.2 Product Features

- Automobile Grade Battery Cells
- Pure Sine Wave, Appliances Friendly
- Ergonomically Designed, Easy to Carry
- Long Cycle life : > 3000 times
- Bidirectional Inverter Technology
- 8 Safety BMS Protection Modes
- ECO Mode (can set at APP)
- 3 Recharging Ways
- 5 Charging Ways
- 10 Output Ports

4.3 Product Specifications

General Specification	
Model	PE-700
Rated Power	700W
Capacity	307Wh(8S2P) 25.6V 24Ah LFP(LiFePO ₄)
Cycle Life	> 3000 cycles
Dimensions	255 x 170 x 180 mm
Net Weight / Gross Weight	5.5kg / 5.7kg
Certifications	UN38.3, CE, RoHS, FCC, PSE, ETL(UL2743) , MIC (According to different country)
Bluetooth	Support
Housing	PC+ABS
Monitor	LCD
Color	Optional
Stand-by Power Consumption	< 2W
Recharging and Charging at the same time	Support

Output Ports (Charging Port)	
AC Pure Sine Wave	1*AC Output 50Hz (220-240V version) 700W 3.5A (Total)
USB-A1/A2) (Fast Charge)	5V \Rightarrow 2.4A 9V \Rightarrow 2A 12V \Rightarrow 1.5A (18W Max)
USB-C1	5/9/12/15V \Rightarrow 3A 20V \Rightarrow 5A (100W Max)
USB-C2 , USB-C3	5/9/12/15V \Rightarrow 3A 20V \Rightarrow 5A (100W Max)
DC5521 (X2)	13.6V \Rightarrow 5A (Total 10A)
Cigarette Lighter	13.6V \Rightarrow 8A
Input Ports (Recharging Port)	
AC Charger (X1)	50Hz 5A 250W (220-240V version)
Solar/Car Charger (X1)	11-28V \Rightarrow 8A 200W
Belt	
Fold/Open Length	22cm/40cm
LED light for Emergency	
LED Power	3w
LED Mode	(High/Medium/Low/Flash/SOS)
BMS Multi Protection	
Over Voltage/Over Current/Over Charge/Over Discharge/Overload/Short Circuit / High Temperature/Low Temperature Protection	
Environmental Operating Temperature	
Charge Temperature	0°C- +45°C (32°F- 113°F)
Discharge Temperature	-25°C- +45°C (-13°F- 113°F)
Storage Temperature	-20°C- +60°C (-4°F- 140°F)
Operating Temperature	20°C- +35°C (68°F- 86°F)
Operating Humidity	5-90%
Storage Humidity	5-95%
Altitude of Operation	2000meters
Heat-dissipating method	Smart Forced Air Cooling
IP levels	IP20

4.4 Product Overview

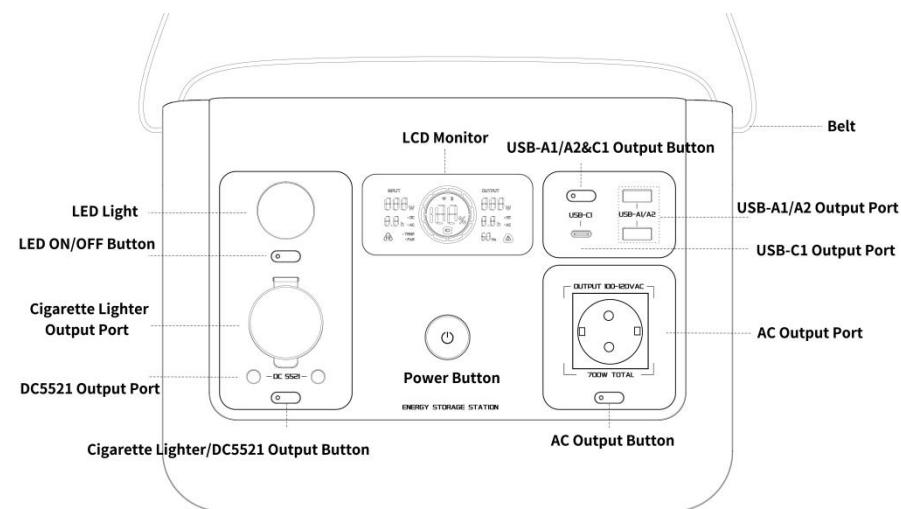

Front-view

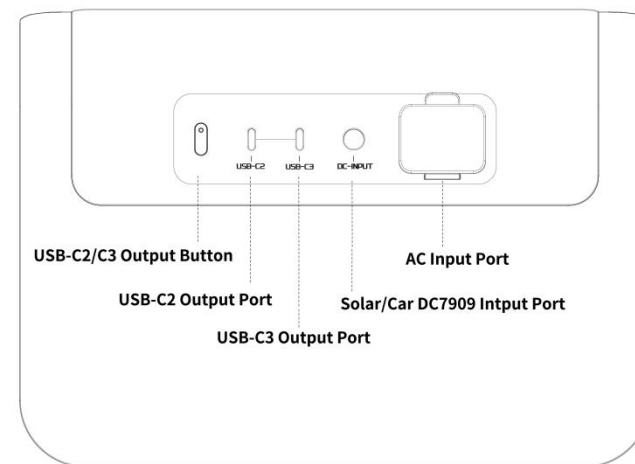

Back-view



The type of AC output socket varies in different countries, the picture above is for illustration only, please refer to the actual product.

4.5 Product LCD Screen

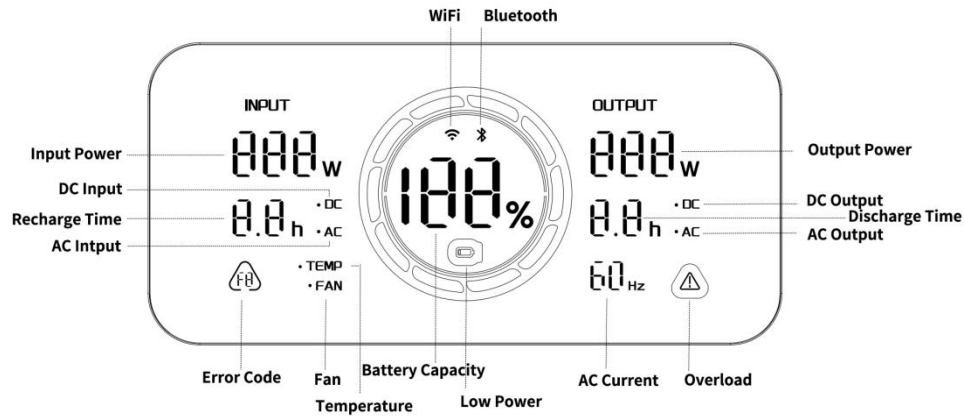

Icon	Name	State
	Remaining Battery Percentage	Full Charged: 100%
	Recharging	Input Power
	Charging	Output Power
	Time	Recharging Time / Charging Time
	Error	Error Code



Error code Refer to "Troubleshooting" for details.

4.6 Product Power ON/OFF

Power ON : Press down and hold the Main Power button for at least 3 seconds to turn on the product, then the LCD screen lights up and the battery indicator icon shows up.

Power OFF : Press down and hold the Main Power button for at least 3 seconds to turn off the product.

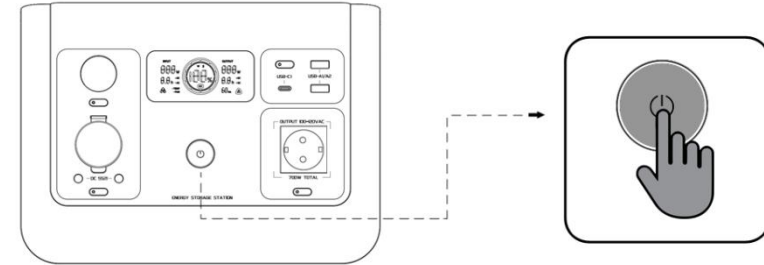

1. After Main Power is turned on, the small main power indicator led will enter breathing mode and the LCD display is ON.
2. If the product is not used for 5 minutes, it will enter sleep mode with the LCD screen shut off. When you start to use the product again, the LCD screen will turn on automatically.
3. The product defaults to 2 hours of standby time. With all the output power buttons turned off and no other load for 2 hours, the product will shut off automatically. You can set the standby duration in the app.

4.7 LED Light

Short Press the LED ON/OFF button to switch to LED light different mode.

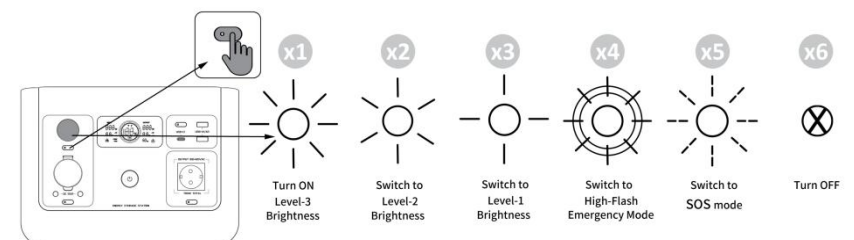

4.8 Charge Your Device



Make Sure Main Power is turned ON, then start below steps.

4.8.1 USB Charging (100W Max)

- ① Short Press the USB ON/OFF button to activate USB output.
- ② Connect your devices to the USB output ports.
- ③ After devices finish charging, short press USB ON/OFF button to shut down USB output.

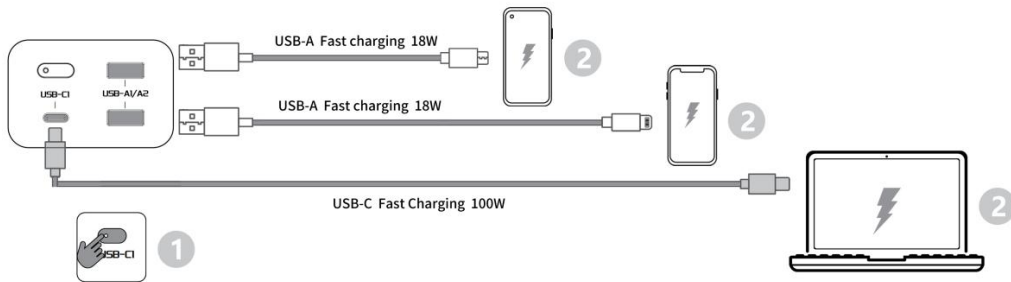

4.8.2 AC Charging (700W Max)

- ① Short Press the AC ON/OFF button to activate AC output.
- ② Connect your devices to the AC output ports.
- ③ After devices finish charging, short press AC ON/OFF button to shut down AC output.



When AC output is active, even there is no device in charging, it still have power consuming. It is recommend to shutdown AC output when no device in charging. (AC output socket varies in different countries or regions, the picture above is for illustration only, please refer to the actual product.)

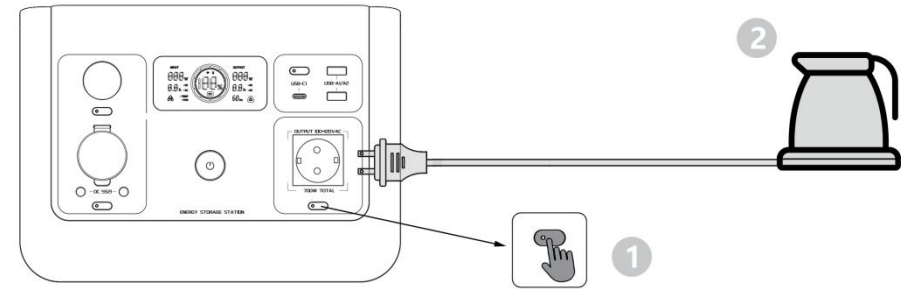

4.8.4 DC Charging (10A Max)

- ① Short Press the 13.6V ON/OFF button to activate DC output.
- ② Connect your devices to the DC output ports via DC cable.
- ③ After devices finish charging, short press 13.6V ON/OFF button to shut down DC output.

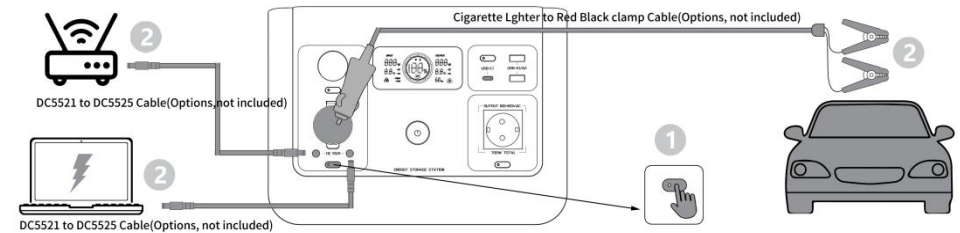

4.9 Recharge Your Power Station

4.9.1 AC Recharging (250W Max)

Recharge your power station by connecting to a wall outlet with the AC charging cable.
0-80% charged in 1 hour ; 0-100% charged in 1.5 hour.

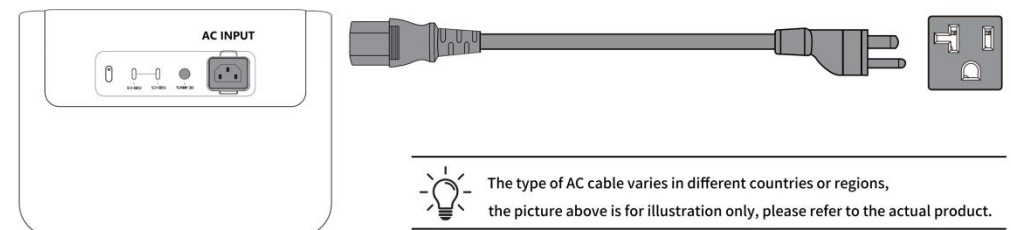

4.9.2 Car Recharging (200W Max)

Recharge your power station by connecting to a cigarette lighter to DC7909 charging cable.
12V 8A 96W 0-100% charged in 3.5 hour; 24V 8A 192W 0-100% charged in 1.8 hour.

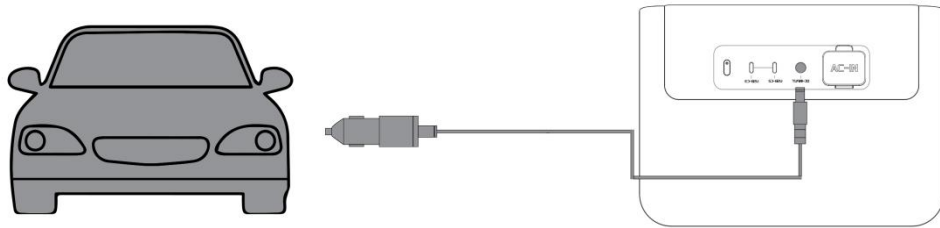

4.9.3 Solar Panel Recharging (200W Max)

Recharge your power station by connecting 1pcs solar panel with output DC7909 port.

100W : 0-100% charged in 4.5 hours. 200W : 0-100% charged in 2.2 hours.

100W or 200W Solar Panel

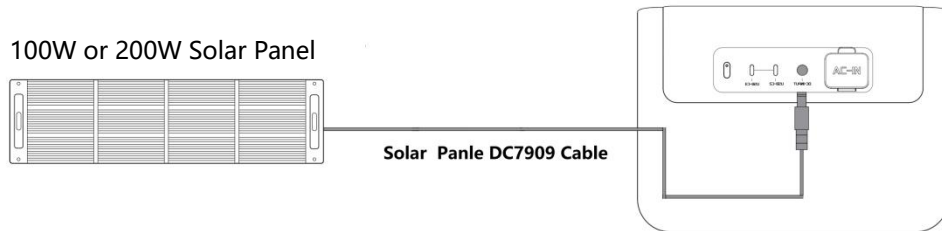

If 1pcs solar panel or 2pcs in parallel output ports are MC4 connector , you need a MC4 to DC7909 charging cable(not included in packing) to connect the power station

200W : 0-100% charged in 2.2 hours.

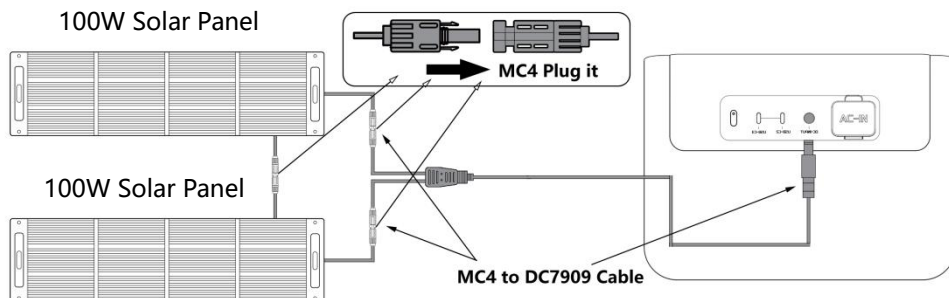

4.10 EPS (Emergency Power Supply)



Provide a basic UPS function, this function does not support 0ms switching. Please do not connect the product to any device that requires 0ms UPS, such as data servers and workstations. Please test and confirm the compatibility before using the product. We recommend that you only charge one device at a time and avoid using multiple ones at the same time to avoid overload protection. SOSEN INNOVATION takes no responsibilities for any device failures or data losses caused by failures to follow instructions.

The product supports EPS function. When you connect the grid power to the AC Input Port of the product through an AC cable, you can power electrical devices through the AC Output Port (AC power will come from the grid and not the power station in this situation). In case of a sudden blackout, the product can automatically switch to the battery powered supply mode within 30ms.

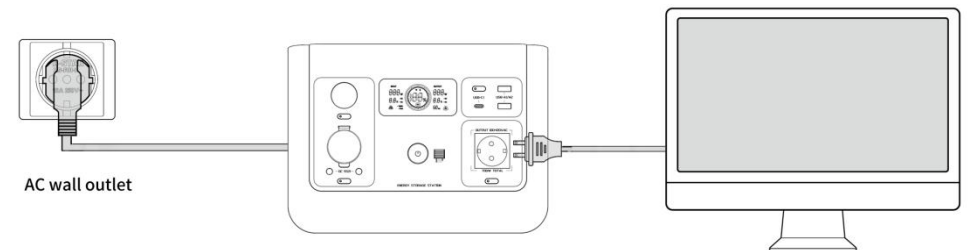

4.11 Estimated Usage Time



$Wh \times \eta \times DOD \div (\text{Load } W) = \text{Charging Time (unit:hour)}$











H = 90% (conversion efficiency)

DOD=80%-90% (determined by ambient temperature and discharge rate)

Load W = Your device power

(Note: These are estimates and may vary by environment, usage, and firmware version)

Off-Grid Life

 Phone (Type-C) 11Wh/ 22 Times	 Laptop (Type-C) 60Wh/ 4 Times	 Switch (Type-C) 16Wh/ 15 Times	 Drone (Type-C) 22Wh/ 11 Times	 Camera (USB) 16Wh/ 15 Times
 Projector (AC) 50W/ 5 Hours	 Speaker (AC) 10Wh/ 24.8 Hours	 Car Fridge (DC) 60W/ 4.1 Hours	 WiFi-Router (DC) 10W/ 24.8 Hours	 Kettle (AC) 700W/ 0.3 Hours

5. FAQ (Frequently Asked Questions)

1. What kinds of devices can be powered by this product?

Such as Mobile Phones, Computers, Refrigerators, Rice cookers, Electric kettles, Lights and most household appliances and outdoor electricity.

2. What's the max power output of the AC output ports?

700W. You are advised to check the power of the appliances before use and ensure that the sum of the power of all loaded devices is less than the rated power.

3. Can this product be charged and discharged at the same time?

YES. The product supports simultaneous charging and discharging. When you plug the power supply of this product into the wall socket, the electronic device will be directly powered by the grid, not by the product battery. In the event of a power failure, the product will automatically switch to battery power within 30ms.

4. Why AC stop output when power station battery capacity less than 10% ?

Battery capacity :100%- 15% : AC output power is 700W,

Battery capacity < 15% : AC output power down to 300W,

Battery capacity < 10% : AC output power down to 100W or Shutdown AC output to avoid over discharging(protect the battery)

Note: even battery capacity less than 10%, USB-A and USB-C port can still work normally.

5. What does ECO mode mean?

In ECO mode (the default setting), if the AC output is less than 10W or the DC output is less than 1W, lasting for 4 hours. The AC output or DC output is automatically turned off to save power consumption. We hope this design can benefit to our users.

6. Can I carry this product on the plane?

NO.



7. Can this product be connected to a home circuit breaker box?

NO.

6. Storage and Maintenance

1. Please use or store the product in an environment temperature between 68°F to 86°F (20°to 30°C) , away from water, heat, and other metal objects.
2. For long-term storage, please discharge the battery to 30% and recharge it to 80% every three months.
3. For safety, please do not store the product in an environment temperature higher than 113°F(45°C) or lower than 14°F (-10°C) for a long time.
4. If the remaining battery is less than 10% after you finish using the product, please recharge it to 60% before storing. If the product is left idle for a long time with severely low battery, irreversible damages may be caused to the battery cell and the product service life will be shortened.
5. If the product has been idle for too long and the battery is severely low, it will enter a deep sleep protection mode. In such case, please charge the product before using it again.
6. If dirt in the interface of the product, please clean the product with a dry, soft and clean wiper or paper towel. Do not use gasoline, volatile oil, thinner, kerosene and other resins with dissolving function.
7. Do not stack anything on top of the unit either in storage or in use.
8. Avoid exposing the unit to rainy or wet environment and in direct sunlight.

7. Troubleshooting

Icon indicator	Name	State
• AC	AC Recharging	AC is recharging your power station
• DC	Solar/Car Recharging	Solar/Car is recharging your power station
	Bluetooth	Bluetooth is ON
	WiFi	WiFi is ON
60 _{Hz}	AC Current	60Hz or 50Hz

Icon indicator	Problem	Solution
	AC Output Overload Protection	Normal operation will resume automatically once you remove the overloaded device and restart the product. Electrical appliances should be used within rated power.
• FAN	Fan Error	ON: Smart Cooling OFF: Normal Blink: Fan Failure
• TEMP	High Temperature Protection	The power supply temperature is over 140°F(60°C), it can be resumed automatically after the battery cools down to 122°F(50°C).
	Low Temperature Protection	When environment temperature is lower -13F(-25°C), stop. The power supply can be resumed automatically after the environment temperature rises above -13F(-25°C).

8. FCC Warning

This device complies with Part 15 of the FCC Rules. Operation of the product is subject to the following conditions:

- (1) this device may not cause harmful interference.
- (2) this device must accept any interference received, including interference that may cause undesired operation.

Warning: Any changes or modifications not expressly approved by the party responsible

for compliance could void the user's authority to operate the equipment.

NOTE: This equipment has been tested and found to comply with the limits for a Class B digital device, pursuant to Part 15 of the FCC Rules. These limits are designed to provide reasonable protection against harmful interference in a residential installation. This equipment generates, uses, and can radiate radio frequency energy, if not installed and used in accordance with the instructions, may cause harmful interference to radio communications. However, there is no guarantee that interference will not occur in a particular installation.

Attention: If this equipment does cause harmful interference to radio or television reception, which can be determined by turning the equipment off and on, the user is encouraged to try to correct the interference by one or more of the following measures:

- (1) Reorient or relocate the receiving antenna.
- (2) Increase the separation between the equipment and receiver.
- (3) Connect the equipment into an outlet on a circuit different from that to which the receiver is connected.
- (4) Consult the dealer or an experienced radio/TV technician for help.

FCC Radiation Exposure Statement:

This equipment complies with FCC radiation exposure limits set forth for an uncontrolled environment. This equipment should be installed and operated with a minimum distance of 20cm (0.65ft) between the radiator and your body.