

# User Manual

---

## Hybrid Inverter SSE-HH8-12K-P3EU Series

**SSE-HH8K-P3EU**  
**SSE-HH10K-P3EU**  
**SSE-HH12K-P3EU**



Please read this manual before use and follow its guidance.  
Keep this manual for future reference.

# CONTENTS

1.About This Manual .....	1
1.1 Applicable Model .....	1
1.2 Target Group .....	1
1.3 Symbol Definition .....	1
1.4 Updates .....	1
2.Safety Precaution .....	2
2.1 General Safety .....	2
2.2 PV String Safety .....	2
2.3 Inverter Safety .....	2
2.4 Battery Safety .....	3
2.5 Personal Requirements .....	3
2.6 EU Declaration of Conformity .....	4
3.Product Introduction .....	4
3.1 Product Features .....	4
3.2 Working Mode .....	6
1.TOU means time of use .....	6
3.3 Appearance .....	7
4. Check and Storage .....	11
4.1 Check Before Receiving .....	11
4.2 What's in the box? .....	11
4.3 Storage .....	12
5.Installation .....	12
5.1 Installation Requirements .....	12
5.2 Inverter Installation .....	15
6.Electrical Connection .....	16
6.1 Safety Precaution .....	16
6.2 Connection Port Description .....	17
6.3 PE Cable Connection .....	18
6.4 PV Connection .....	18
6.5 EPS and Grid,Generator Connection .....	20
6.6 Battery Connection .....	25
6.7 Communication Cable Installation .....	26
6.8 Wi-Fi&BLE stick installation .....	29
7.Operation .....	31
7.1 Indicator panel .....	31
8.Trouble Shooting .....	31
9.Maintenance .....	34
9.1 Power Off the Inverter .....	34
9.2 Removing the Inverter .....	34
9.3 Disposing of the Inverter .....	34
9.4 Routine Maintenance .....	34

# 1.About This Manual

This manual describes the product information, installation, electrical connection, commissioning, troubleshooting, and maintenance. Read through this manual before installing and operating the product. All the installers and users have to be familiar with the product features, functions, and safety precautions. This manual is subject to update without notice. For more product details and latest documents, visit <https://www.sosencx.com>.

## 1.1 Applicable Model





Model	Nominal Output Power	Nominal Output Voltage
SSE-HH8K-P3EU	8000W	400/230V a.c, 3W+N+PE
SSE-HH10K-P3EU	10000W	400/230V a.c, 3W+N+PE
SSE-HH12K-P3EU	12000W	400/230V a.c, 3W+N+PE

## 1.2 Target Group

This manual is intended for qualified and knowledgeable electrical technical personnel who are responsible for hybrid inverter installation and commissioning in the energy storage system and electric system.

## 1.3 Symbol Definition

The following types of safety instructions and general information appear in this document as described below:

 <b>DANGER</b>	 <b>WARNING</b>	 <b>CAUTION</b>	 <b>NOTICE</b>
“Danger” indicates a hazardous situation with a high level of risk that, if not avoided, will result in death or serious injury.	“Warning” indicates a hazardous situation with a medium level of risk that, if not avoided, could result in death or serious injury.	“Caution” indicates a hazardous situation with a low level of risk that, if not avoided, could result in minor or moderate injury.	“Notice” provides some tips and methods to solve product-related problems to save time.

## 1.4 Updates

The latest document contains all the updates made in earlier issues.

V1.0 2023-11-22

- First Issue

## 2.Safety Precaution

Please strictly follow these safety instructions in the user manual during the operation.

### 2.1 General Safety

#### NOTICE

- The information in this user manual is subject to change due to product updates or other reasons. This guide cannot replace the product labels or the safety precautions in the user manual unless otherwise specified. All descriptions here are for guidance only.
- Before installations, read through the quick installation guide. For additional information, please see the user manual.
- All installations should be performed by trained and knowledgeable technicians who are familiar with local standards and safety regulations.
- Use insulating tools and wear personal protective equipment when operating the equipment to ensure personal safety. Wear anti-static gloves, cloths, and wrist strips when touching electron devices to protect the inverter from damage.
- Strictly follow the installation, operation, and configuration instructions in this manual. The manufacturer shall not be liable for equipment damage or personal injury if you do not follow the instructions. For more warranty details, please visit <https://www.sosencx.com/>.

### 2.2 PV String Safety

#### DANGER

Connect the DC cables using the delivered PV connectors. The manufacturer shall not be liable for the equipment damage if other connectors or terminals are used.

#### WARNING

- Ensure the component frames and the bracket system are securely grounded.
- Ensure the DC cables are connected tightly, securely, and correctly.
- Measure the DC cables with a multimeter to avoid reverse polarity connection. Also, the voltage should be under the permissible range.
- Do not connect one PV string to more than one inverter at the same time. Otherwise, it may cause damage to the inverter.
- The PV modules used with the inverter must have an IEC61730 class A rating.
- When the photovoltaic array is exposed to light, it supplies a d.c. voltage to the inverter.











### 2.3 Inverter Safety

#### WARNING

- The voltage and frequency at the connecting point should meet the on-grid requirements.
- Additional protective devices like circuit breakers or fuses are recommended on the AC side. Specification of the protective device should be at least 1.25 times the AC rated output current.
- Make sure that all the groundings are tightly connected. When there are multiple inverters, make sure that all the grounding points on the enclosures are equip Potential bonding.
- Off-grid function is not recommended if the PV system is not configured with batteries. Otherwise, the risk in system power usage is beyond the equipment manufacturer's warranty scope.
- It should be taken into account the characteristics of photovoltaic power instability, if the battery is not connected, there is no EPS function.

**⚠ DANGER**

- All labels and warning marks should be visible after the installation. Do not cover, scrawl, or damage any label on the equipment.
- Warning labels on the inverter are as follows:

	DANGER High voltage hazard. Disconnect all incoming power and turn off the product before working on it.		Delayed discharge. Wait 5 minutes after power off until the components are completely discharged.
	Read through the user manual before working on this device.		Potential risks exist. Wear proper PPE before any operations.
	High-temperature hazard. Do not touch the product under operation to avoid being burnt.		Grounding point.
	With CE mark & the inverter fulfills the basic requirements of the guideline governing Low-Voltage and electromagnetic compatibility.		Do not dispose of the inverter as household waste. Discard the product in compliance with local laws and regulations, or send it back to the manufacturer.
	UKCA marking Indicates compound UK product safety certification requirements.		RCM marking

## 2.4 Battery Safety

**⚠ WARNING**

- The battery used with the inverter shall be approved by the inverter manufacturer. The approved battery list can be obtained through the official website.
- Before installations, read through the corresponding battery's User Manual to learn about the product and the precautions. Strictly follow its requirements.
- If the battery discharged completely, please charge it in strict accordance with the corresponding model's User Manual.
- Factors such as: temperature, humidity, weather conditions, etc. may limit the battery's current and affect its load.
- Contact after-sale service immediately if the battery is not able to be started. Otherwise, the battery might be damaged permanently.
- Use the multimeter to measure the DC cable to avoid reverse polarity connection. Also, the voltage should be under the permissible range.
- Do not connect one battery group to several inverters at the same time. Otherwise, it may cause damage to the inverter.

## 2.5 Personal Requirements

**💡 NOTICE**

- Personnel who install or maintain the equipment must be strictly trained, learn about safety precautions and correct operations.
- Only qualified professionals or trained personnel are allowed to install, operate, maintain, and replace the equipment or parts.

## 2.6 EU Declaration of Conformity

Shenzhen Sosen Innovation Technology Co., Ltd. hereby declares that the inverter with wireless communication modules sold in the European market meets the requirements of the following directives:

- Radio Equipment Directive 2014/53/EU (RED)
- Restrictions of Hazardous Substances Directive 2011/65/EU and (EU) 2015/863 (RoHS)
- Waste Electrical and Electronic Equipment 2012/19/EU
- Registration, Evaluation, Authorization and Restriction of Chemicals (EC) No 1907/2006 (REACH)

Shenzhen SOSEN Innovation Technology Co., Ltd. hereby declares that the inverter without wireless communication modules sold in the European market meets the requirements of the following directives:

- Electromagnetic compatibility Directive 2014/30/EU (EMC)
- Electrical Apparatus Low Voltage Directive 2014/35/EU (LVD)
- Restrictions of Hazardous Substances Directive 2011/65/EU and (EU) 2015/863 (RoHS)
- Waste Electrical and Electronic Equipment 2012/19/EU
- Registration, Evaluation, Authorization and Restriction of Chemicals (EC) No 1907/2006 (REACH)

You can download the EU Declaration of Conformity on <https://sosencx.com>.

## 3.Product Introduction

### 3.1 Product Features

#### Intended usage

The SSE-HH8-12K-P3EU series hybrid inverters apply to energy storage system with battery, loads and grid. The energy produced by PV system shall be used to optimize self-consumption, excess power charge battery and the rest power could be fed into the grid. Battery shall be discharged to support loads when PV power is insufficient to meet self-consumption. If both PV power and battery power is insufficient, the system will take power from grid to support loads. Work mode depends on PV energy and user's preference.

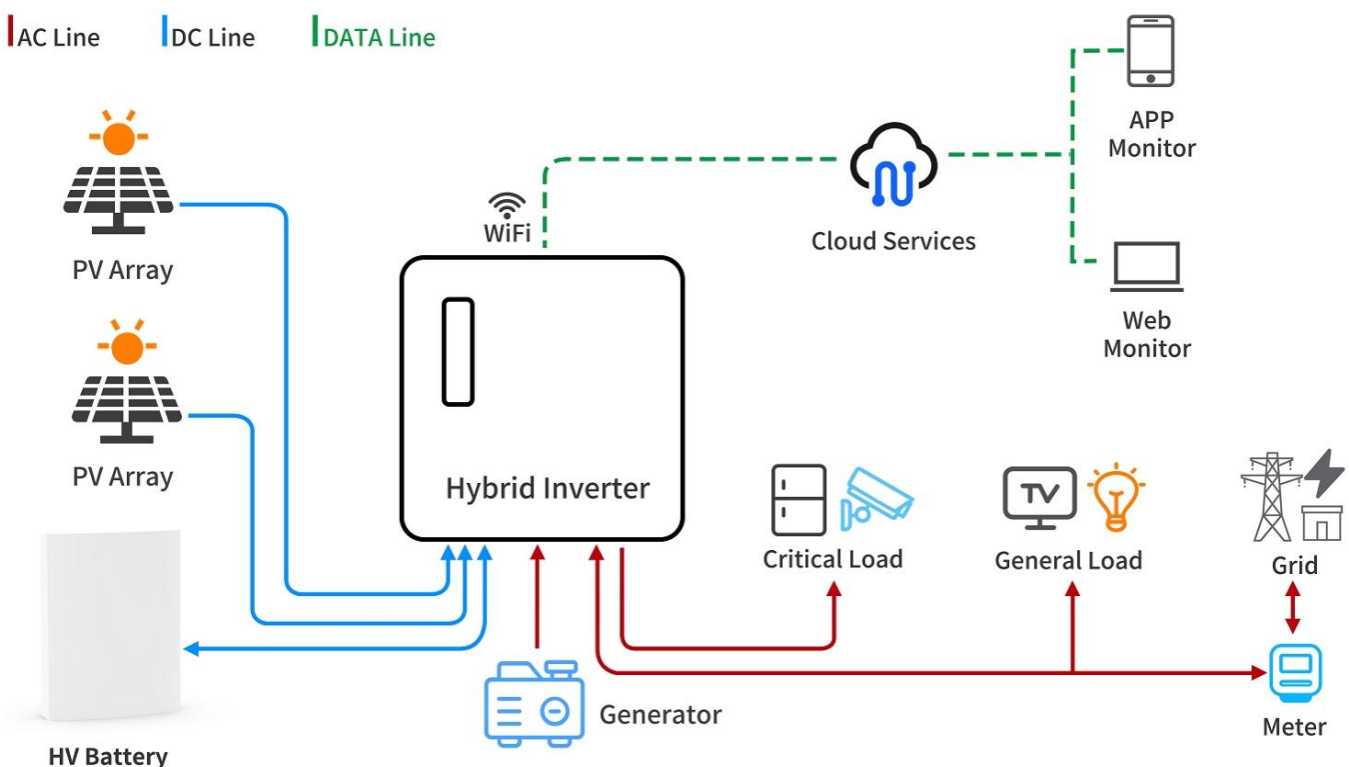

This manual applies to the listed inverters below:

SSE-HH8K-P3EU SSE-HH10K-P3EU SSE-HH12K-P3EU

**Model description**

**SS E - HH 8K - P3 EU**

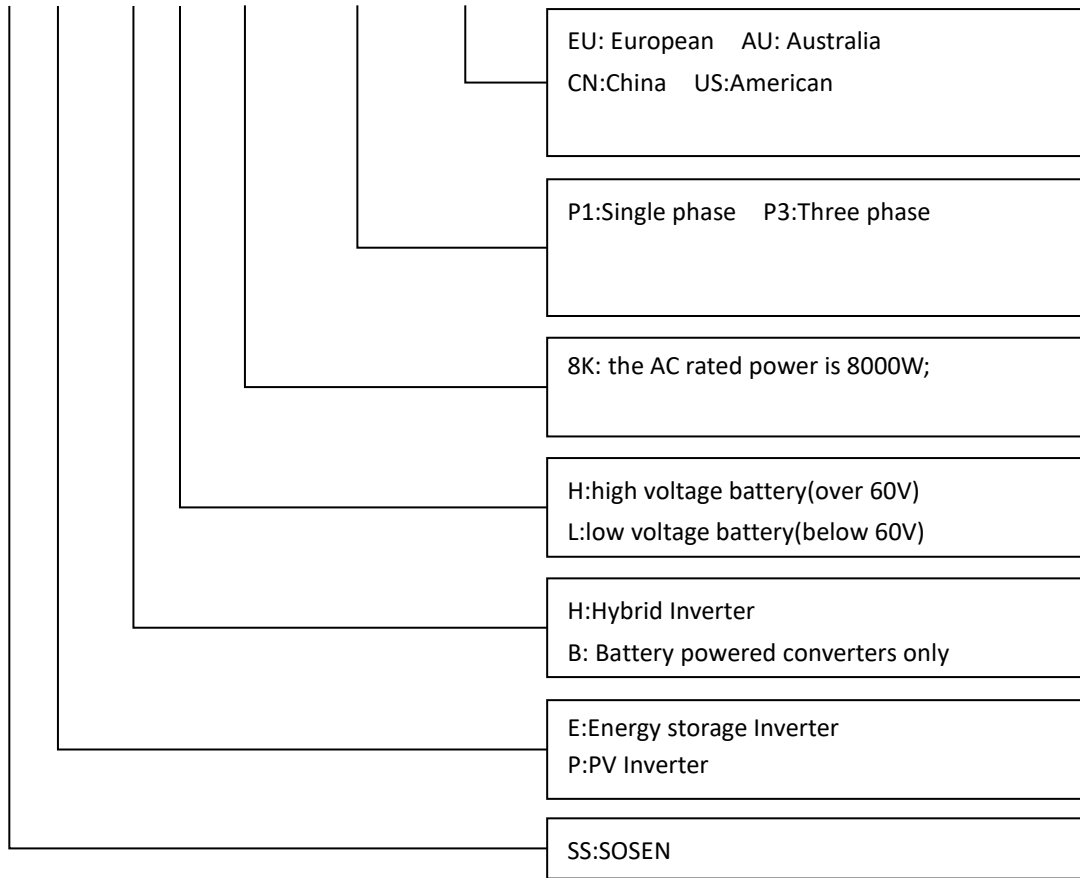

**Series Code:**

**SN: SXXXXXXXX2401100001**

**Series Code description**

No.	Referring to	Code	Description
1	Brand name	S	SOSEN
2	Product category	XXXXXXXX	Inverter model ID
3	Production date	24	The year of production
4	Production date	01	The month of production
5	Production date	11	The day of production
6	Production serial number	00001	

**Hardware Version:V1.0**

**Software Version:V1.03**

### 3.2 Working Mode

The SSE-HH8-12K-P3EU Series hybrid inverter has the following work modes based on your configuration and layout conditions.

Work modes	Description
Self Use (with PV Power)	Priority: load>battery>grid The energy produced by the PV system is used to optimize self-consumption. The excess energy is used to charge the batteries, then exported to grid.
Self Use (without PV Power)	Priority: load>battery When no PV supplied, battery will discharge for local loads firstly, and grid will supply power when the battery capacity is not enough.
TOU <sup>1</sup> Balance	In this mode, users can set the time period, photovoltaic sufficient and time-of-use price area, in the case of large power consumption of users, to achieve the balance of photovoltaic utilization rate and economic benefits. <b>Peak price:</b> Run spontaneous self-use mode. <b>Flat price:</b> The photovoltaic gives priority to the load power supply, and when the photovoltaic power is insufficient, the battery is restricted to discharge to ensure the continuity of energy. <b>Valley price:</b> Charge the battery at full power priority until it is full.
TOU <sup>1</sup> Eco	This mode can be used to meet users' demand for peak cutting and valley filling and achieve maximum economic benefit in areas with large difference of peak and valley electricity price. <b>Peak price:</b> The battery is discharged at full power to sells electricity to the grid at a high price <b>Flat price:</b> Run spontaneous self-use mode. <b>Valley price:</b> Buy electricity from the grid at a low price to charge the battery at full power
Back up only	Priority: load>battery When entering this mode, the system will start to charge the battery until it is fully charged and remains fully charged, waiting for the power grid to fail. When the grid is off, system will supply emergency power from PV or battery to supply the home loads .
Grid Priority	Priority: load>grid When the system works in this mode, the electricity generated by the photovoltaic will be preferentially connected to the grid. Users can send requests to the grid at peak times, and in this mode, users can set the end of the battery SOC point.

1.TOU means time of use.



Make sure the load powering rating in within the EPS's output rating. Or the inverter will shut down with an 'over load' warning. When an “over load” is appeared, adjust the load power make sure it is with the range of the EPS output, and turn the inverter on. For the nonlinear load, please pay attention to the inrush power make sure it is within the range of the EPS output.



### 3.3 Appearance

#### 3.3.1 Dimension

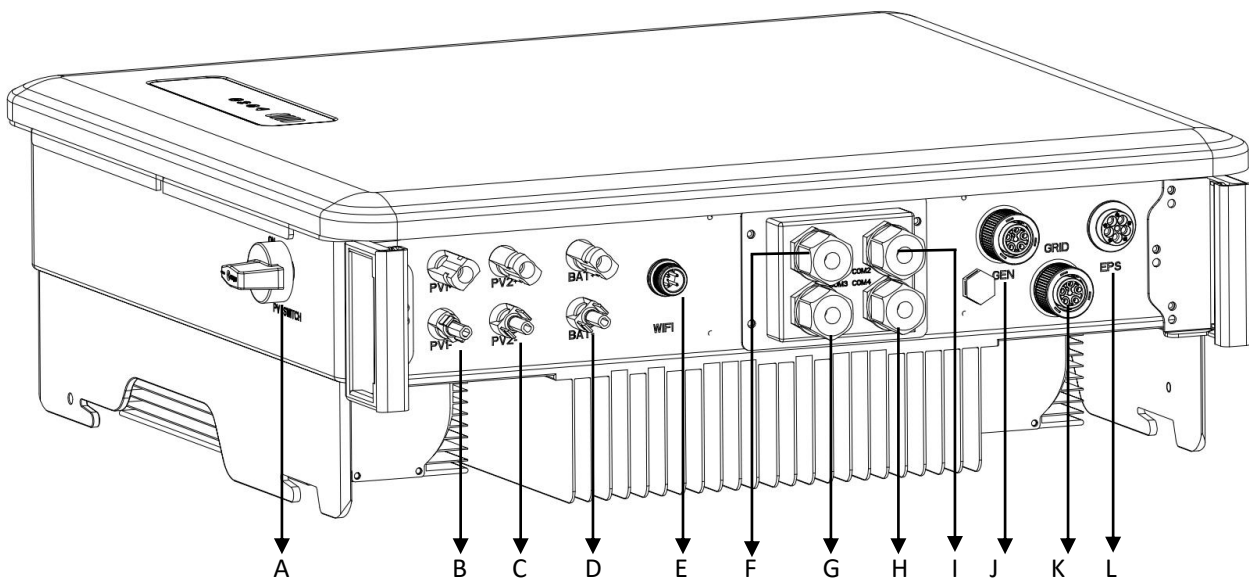
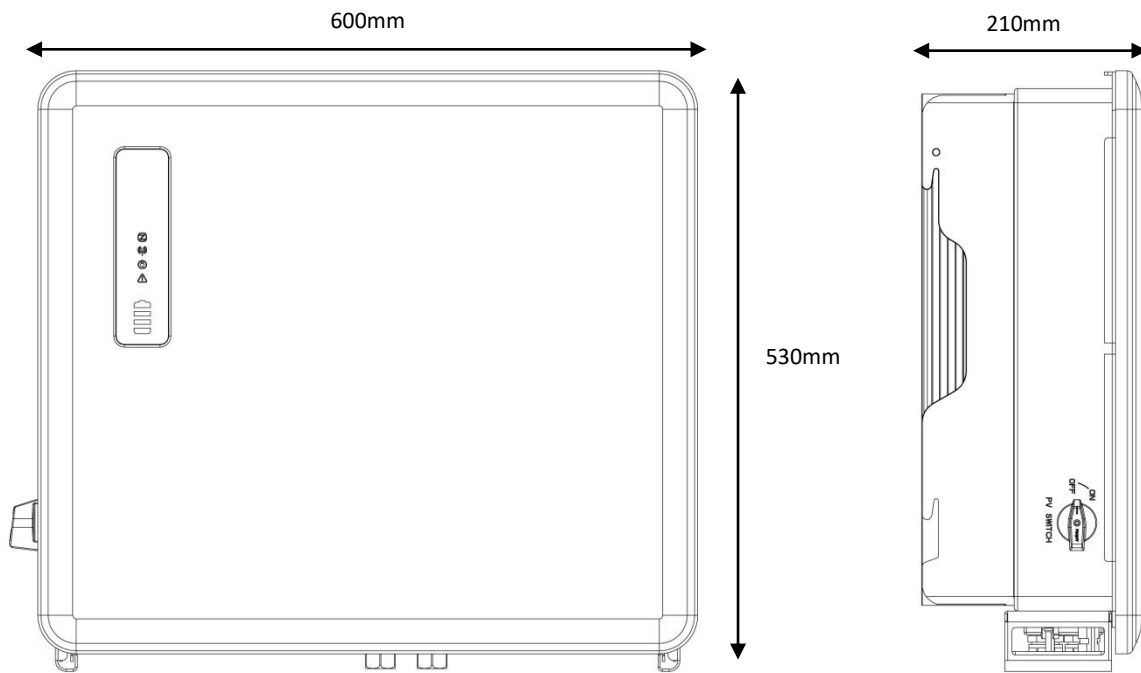

item	Description	item	Description
A	PV switch	B	PV1 connector
C	PV2 connector	D	Battery connector
E	WiFi	F	Meter,CT
G	Parallel connector	H	BMS connector
I	DRM,Dry connector	J	Generator connector
K	Grid connector	L	EPS connector

### 3.3.3 Nameplate

The nameplate is for reference only.



## Hybrid Inverter

Model	SSE-HH12K-P3EU
Vmax PV(Max.PV input voltage)	1000V d.c
PV input operating voltage range	150-950V d.c
Max.operating PV input current	16A d.c*2
Isc PV	24A d.c*2
Grid rated voltage	400/230V a.c, 3W+N+PE
Grid rated frequency	50Hz
Grid rated input current	23.2A a.c
Grid rated output current	17.4A a.c
Grid rated input apparent power	16000VA
Grid rated output apparent power	12000VA
EPS rated output voltage	400/230V a.c, 3W+N+PE
EPS rated output frequency	50Hz
EPS rated output current	17.4A a.c
EPS rated output apparent power	12000VA
Power Factor	0.8Leading-0.8Lagging
Battery operation voltage range	125-800V d.c
Max.charge and discharge current	40A d.c
Battery type	Li-ion/Lead-acid
Protective class	I
Ingress protection degree	IP65
Overvoltage category	PV: II AC:III
Inverter topology	Non-isolated
Operating temperature range	-25°C -+60°C

Manufacturer:

Shenzhen Sosen Innovation Technology Co.,Ltd

Address601,Pengzhanhui,Building1, No.233, Xinqiao Community Center Road,Xinqiao Street, Bao'an District, Shenzhen, China



### 3.3.4 Features

- Intelligent energy management
- Wide range of battery voltage
- High Sealed design With IP65
- Multiple operating modes are available
- Compatible with on grid and off grid
- High efficiency
- High speed on/off grid switching

### 3.3.5 Specification

Model	SSE-HH8K-P3EU	SSE-HH10K-P3EU	SSE-HH12K-P3EU
Product Type	Hybrid Inverter		
<b>Battery</b>			
Battery type	Li-ion/Lead-acid		
Battery voltage range	125-800Vd.c.		
Full power Battery voltage range	300-800V d.c		
Max.charge/discharge Power	8000W	10000W	12000W
Rated battery voltage	200Vd.c.	250Vd.c.	300Vd.c.
Rated charge/discharge current	40Ad.c		
Max. charge/discharge current	40Ad.c		
Reverse Connect Protection	Yes		
Communication interface	CAN/RS485		
<b>Input (PV)</b>			
Recommended Max. PV array power for each input	6000	7500	9000
Max. operating PV input current ( PV 1 /PV 2)	16/16A d.c		
Max. Isc PV ( PV 1 /PV 2)	24/24 A d.c		
Vmax PV (Max. PV input voltage)	1000V d.c		
MPPT Voltage Range	150-950V d.c		
PV input operating voltage range	150-950V d.c		
Full power MPPT voltage range	375-850V d.c		
Start-up Voltage	200V d.c		
Number of MPP Trackers	2		
Strings per MPP Tracker	1		
Number of PV input	2		
Wax.inverter backfeed current to the array	0A		
<b>Grid AC input and AC output</b>			
Grid rated voltage	400/230 a.c, 3W+N+PE		
Grid rated frequency	50Hz		
Grid rated input active power	12000W	14000W	16000W
Grid rated input apparent power	12000VA	14000VA	16000VA
Grid Max. input active power	12000W	14000W	16000W
Grid Max. input apparent power	12000VA	14000VA	16000VA
Grid rated output active power	8000W	10000W	12000W
Grid rated output apparent power	8000VA	10000VA	12000VA
Grid Max. output active power	8800W	11000W	13200W
Grid Max. output apparent power	8800VA	11000VA	13200VA
Grid rated input current	17.4A a.c	20.3A a.c	23.2A a.c
Grid Max. input current	17.4A a.c	20.3A a.c	23.2A a.c
Grid rated output current	11.6A a.c	14.5A a.c	17.4A a.c
Grid Max. output current	12.8A a.c	15.9A a.c	19.1A a.c
Grid power factor	0.8 leading to 0.8 lagging		
Grid input and output Inrush current	96A a.c @ 3μs		
Max. Grid output fault current	96A a.c @ 3μs		
Max. Grid output overcurrent protection	400V a.c /60 A a.c		
Grid input Icc (Rated conditional short-circuit current)	500A a.c		
Grid input Icw (Rated short-time withstand current)	500A a.c		
Total Harmonic Distortion(THDi, rated power)	<3%		

EPS output	SSE-HH8K-P3EU	SSE-HH10K-P3EU	SSE-HH12K-P3EU
EPS rated output Voltage	400/230a.c, 3W+N+PE		
EPS rated output frequency	50Hz		
EPS rated output active power	8000W	10000W	12000W
EPS rated output apparent power	8000VA	10000VA	12000VA
EPS Max. output active power	8800W	11000W	13200W
EPS Max. output apparent power	8800VA	11000VA	13200VA
Eps rated output current	11.6A a.c	14.5A a.c	17.4A a.c
Max. output current	12.8A a.c	15.9A a.c	19.1A a.c
EPS output power factor	0.8 leading to 0.8 lagging		
EPS output peak power	18000VA(<10s)		
EPS output Inrush current	50A a.c @ 10ms		
EPS Max. output fault current	50A a.c @ 10ms		
EPS Max. output overcurrent protection	400V a.c /60 A a.c		
Switch Time	<10ms		
Total Harmonic Distortion(THDv, linear Load)	<3%		
Compatible with the Generator	Optional		
Efficiency			
MPPT Efficiency	99.90%		
Euro-efficiency	97.50%		
Max.efficiency	98.00%		
Standard			
Safety	EN/IEC 62109-1/2, EN/IEC 60529, EN/IEC 62040-1		
EMC	EN IEC 61000-6-1, EN IEC 61000-6-3, EN IEC 61000-3-12, EN IEC 61000-3-11, EN IEC 61000-3-2,EN 61000-3-3		
Grid-interactive	CEI 0-21, EN 50549-1, VDE-AR-N 4105, UNE 217002, NTS TYPEA, G99, AS/NZS 4777.2 and so on		
General Parameter			
Degree of ingress protection	IP65		
Protection class	I		
Environment category	Outdoor		
Wet location classification	Yes		
Pollution degree	PD3		
Operating altitude	4000 m(>2000 Derating)		
Operating ambient temperature	-25 - +60 °C (linely derating to 60% when exceed +45 to +60 °C)		
Operating relative Humidity	0-100% (non-condensing)		
Storage Temperature	-25- +60 °C		
Storage relative Humidity	0-100% (non-condensing)		
Noise Emission(typical)	<35 db		
Overvoltage Category	AC: III, PV: II		
Electrical supply system	TN, TT		
Degree of ingress protection	IP65		
Dimension (WxHxD)	600x530x210mm		
Net Weight	35kg		
Cooling Mode	Natural Cooling		
Topology	Non-isolated		
Active anti-islanding method	Active frequency drift		
Communication	RS485/WiFi/Bluetooth/LAN/CAN/DRM/Meter, Yes/ Yes/ Opt/Opt/ Yes/ Yes/ Opt		
LED indicator	8 led		

## 4. Check and Storage

### 4.1 Check Before Receiving

Check the following items before receiving the product.

1. Check the outer packing box for damage, such as holes, cracks, deformation, and others signs of equipment damage. Do not unpack the package and contact the supplier as soon as possible if any damage is found.
2. Check the inverter model. If the inverter model is not what you requested, do not unpack the product and contact the supplier.
3. Check the deliverable for correct model, complete contents, and intact appearance. Contact the supplier as soon as possible if any damage is found.

### 4.2 What's in the box?

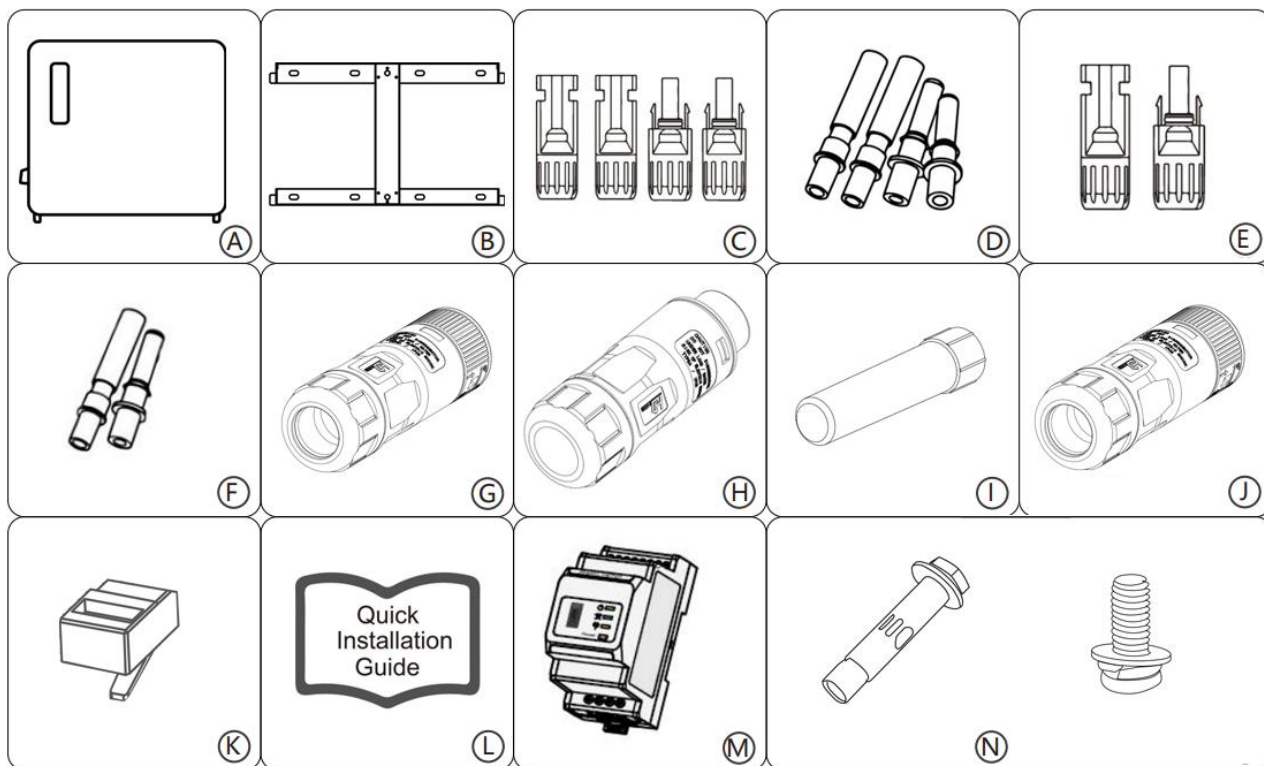

Item	Quantity	Description	Item	Quantity	Description
A	1	Inverter	B	1	Bracket
C	4	PV connectors (Black) (2*positive, 2*negative)	D	4	PV pin contacts(Black) (2*positive, 2*negative)
E	2	Battery connectors(Blue) (1*positive, 1*negative)	F	2	Battery pin contacts(Blue) (1*positive, 1*negative)
G	1	AC EPS terminal (Black) connectors	H	1	AC grid terminal (Black) connectors
I	1	WiFi module	J	1	Generator connector
K	1	RJ45 connector*6	L	1	User manual
M	1	Three-phase electronic type guide rail mounting electric energy meter	N	5	M8*80 Expansion tubes *6 & Expansion screws * 6 PM6*12 stainless steel screw*1

## 4.3 Storage

If the equipment is not to be installed or used immediately, please ensure that the storage environment meets the following requirements:

1. Do not unpack the outer package or throw the desiccant away.
2. Store the equipment in a clean place. Make sure the temperature and humidity are appropriate and no condensation.
3. The height and direction of the stacking inverters should follow the instructions on the packing box.
4. The inverters must be stacked with caution to prevent them from falling.
5. If the inverter has been long term stored, it should be checked by professionals before being put into use.
6. The storage temperature range is:  $-25^{\circ}\text{C}\sim 60^{\circ}\text{C}$ , and the storage humidity is  $0\sim 100\%$ .
7. The box should be suitable for loads more than 35kg.

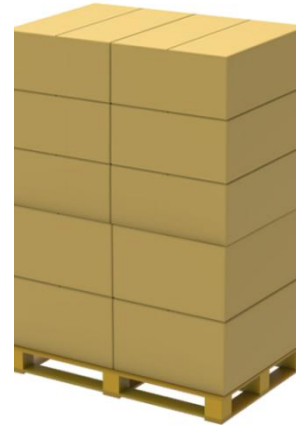

## 5. Installation

### 5.1 Installation Requirements

#### Installation Environment Requirements

1. Do not install the equipment in a place near flammable, explosive, or corrosive materials.
2. Do not install the equipment in a place that is easy to touch, especially within children's reach. High temperature exists when the equipment is working. Do not touch the surface to avoid burning.
3. Avoid the water pipes and cables buried in the wall when drilling holes.
4. Install the equipment in a sheltered place to avoid direct sunlight, rain, and snow. Build a sunshade if it is needed.
5. The place to install the equipment shall be well-ventilated for heat radiation and large enough for operations.
6. The equipment with a high ingress protection rating can be installed indoors or outdoors. The temperature and humidity at the installation site should be within the appropriate range.
7. Install the equipment at a height that is convenient for operation and maintenance, electrical connections, and checking indicators and labels.
8. The altitude to install the inverter shall be lower than the maximum working altitude 4000m.
9. The PV modules used with the inverter must have an IEC61730 class A rating.
10. There should be provided an overcurrent protection (such as a breaker rated 400V a.c /32 A a.c) before AC input and after EPS output, and make sure that the installation position shall not prevent access to the disconnection means.
11. Please ensure that there is adequate ventilation space for the inverter after installation, refer to the installation diagram below.
12. This inverter does not provide an internal isolated transformer between PV input and Battery / AC output circuits, But a basic insulation is provided between PV input / Battery / AC output circuits and metal enclosure / earth, and reinforced / double insulation between PV input / Battery / AC output and communication circuits (DRM / Meter / WiFi/ RS485)
13. The PV input ratings please refer to the specification table of subclause 3.3.5, and please make sure that PV array should not be grounded.
14. Install the equipment away from electromagnetic interference. If there are radio stations or wireless communication equipment below 30 MHz near the installation location, please install the equipment as follows:
  - Add a multi-turn winding ferrite core at the DC input line or AC output line of the inverter, or add a low-pass EMI filter.
  - The distance between the inverter and the wireless EMI equipment is more than 30m.

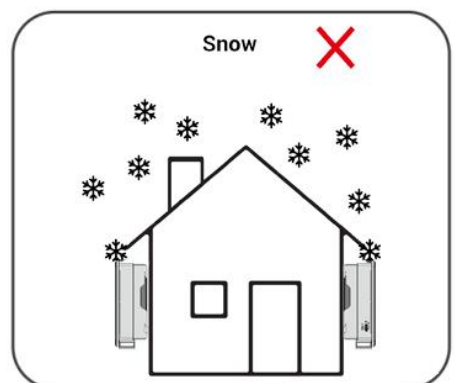
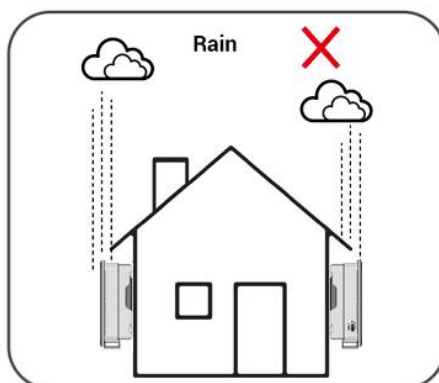
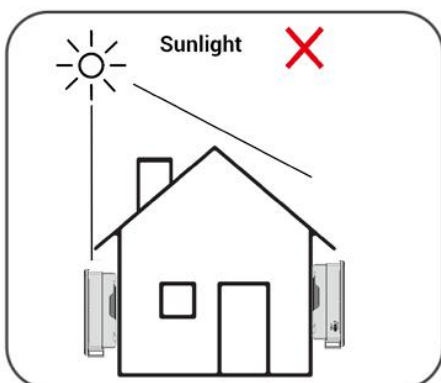
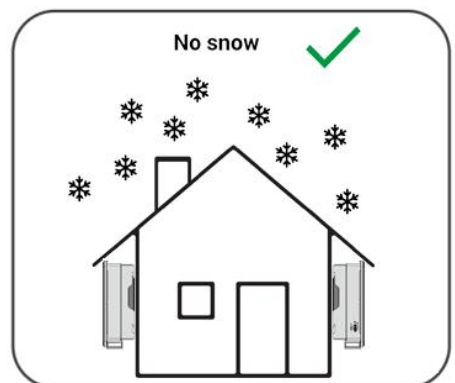
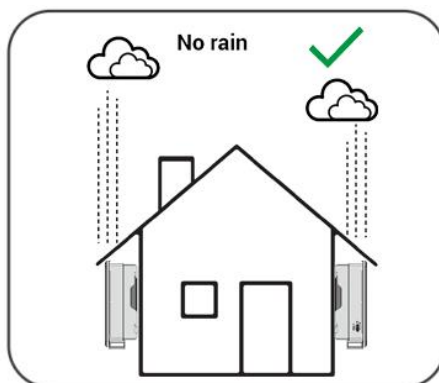
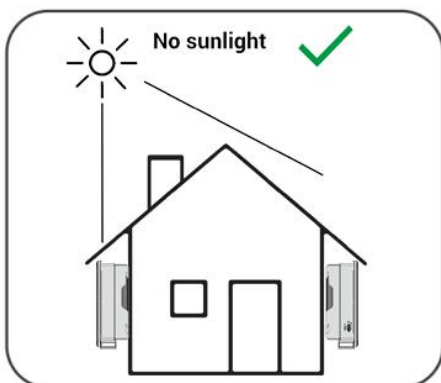
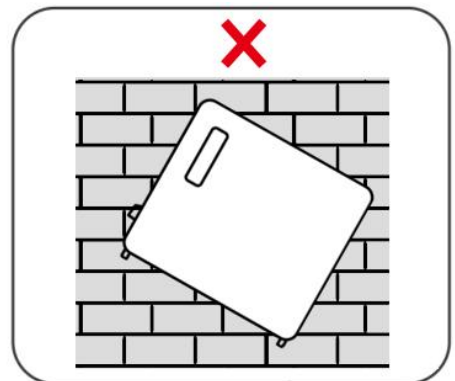
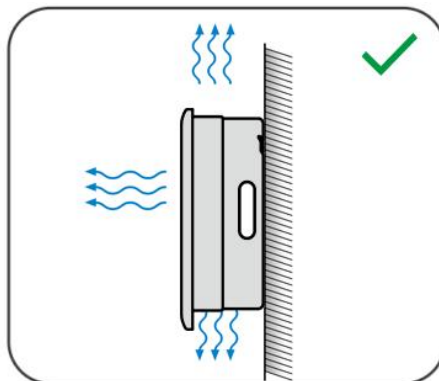
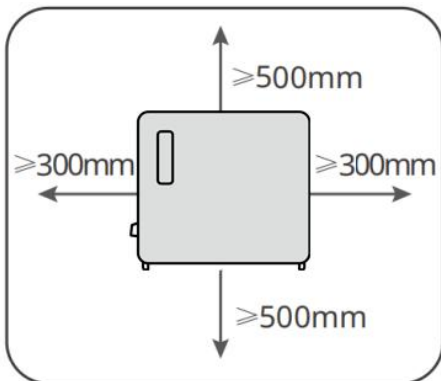
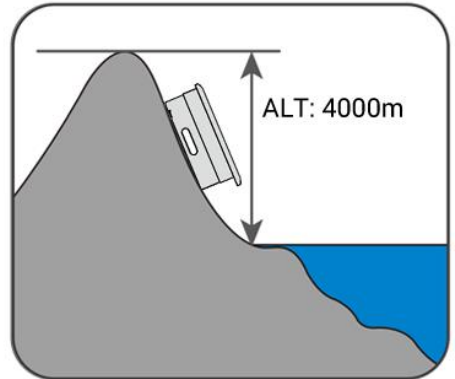
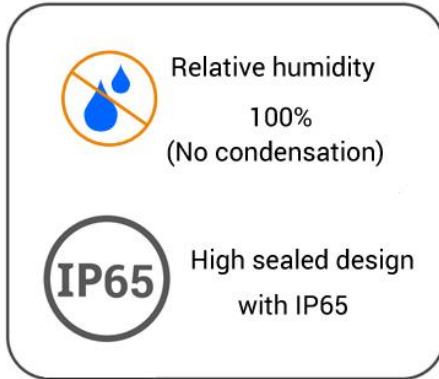
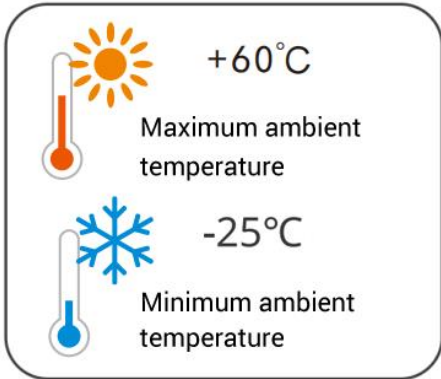
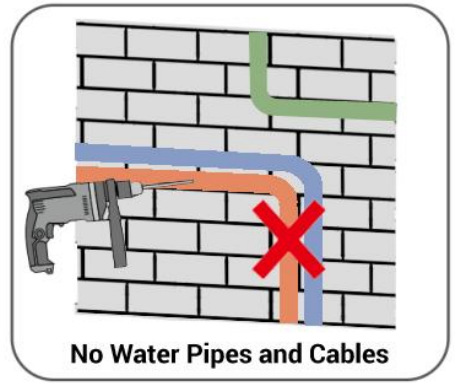
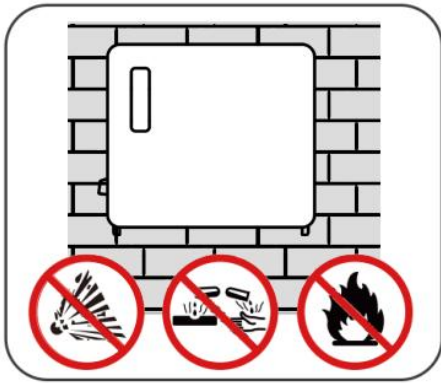



### Installation Angle Requirements

- Install the inverter vertically or at a maximum back tilt of 15 degrees.
- Do not install the inverter upside down, forward tilt, back forward tilt, or horizontally.

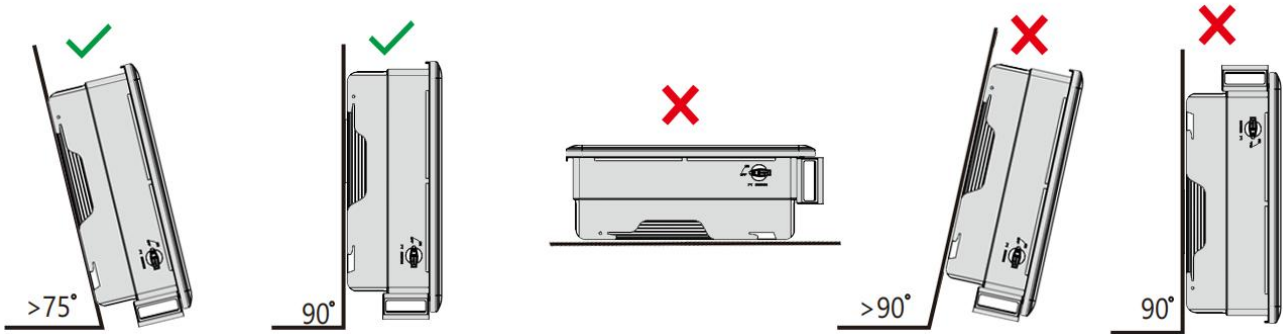

### Installation Tool Requirements

The following tools are recommended when installing the equipment. Use other auxiliary tools on site if necessary.





## 5.2 Inverter Installation

### 5.2.1 Moving the Inverter

 CAUTION

- The unit is heavy. Do not lift it alone. During lifting procedures ensure that the unit is firmly secured to avoid the risk of accidental tipping or dropping. Parts serving for support or immobilization of unit shall be designed and manufactured so as to minimize the risk of physical injuries and of accidental loosening of fixing. Ensure that the method of lifting will not allow the unit to slip from chains and slings or turn-over or slide from lifting devices.
- Transportation must be carried by specialized person (truck operators, Hook-up personal), equipped with the necessary protection equipment (overalls, safe shoes, protective gloves, helmets, goggles)
- Do not walk or stand beneath or in the proximity of the load. Avoid sudden movements and jolts when unloading and positioning the unit, Internal handling procedures must be conducted with care.
- Do not exert leverage on the components of the machine. If the unit is not balanced apply ballast, Any protruding parts should not be supported by hand. The inverter should be installed so that the operating panel shall be easily accessible- easy access to the electrical power connection point.
- Accessible for maintenance and repair work. Parts serving for support or immobilization of unit shall be designed and manufactured so as to minimize the risk of physical injuries and accidental loosening of fixings.
- Loading capacity and hardness of the supporting surface, load rating of mounting bracket should be at least four times the weight of the devices according to IEC62109-1. And supporting characteristics will be impaired by wear, corrosion, material fatigue or ageing, This should be calculated by inspection of the design data of supporting material and consulting construction engineer.

### 5.2.2 Installing Steps

 NOTICE

- Avoid the water pipes and cables buried in the wall when drilling holes.
- Wear goggles and a dust mask to prevent the dust from being inhaled or contacting eyes when drilling holes.
- Make sure the inverter is firmly installed in case of falling down.

**Step 1** : Put the mounting plate on the wall or the support horizontally and mark positions for drilling holes.

**Step 2** : Drill holes to a depth of 80mm using the hammer drill. The diameter of the drill bit should be 10mm.

**Step 3** : Secure the mounting plate using the expansion bolts.

**Step 4** : Install the inverter on the mounting plate.

**Step 5**: Make sure the pin hook the inverter

**Step 6** : Install the screw to lock it tight.

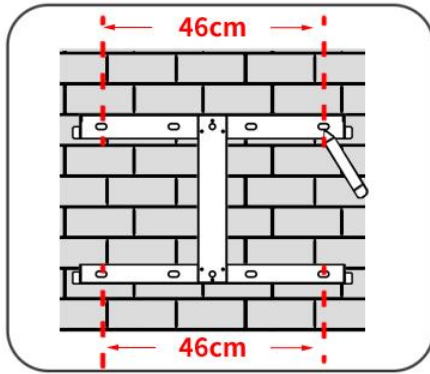

Step 1

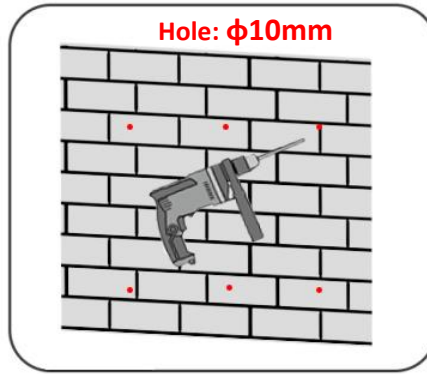

Step 2

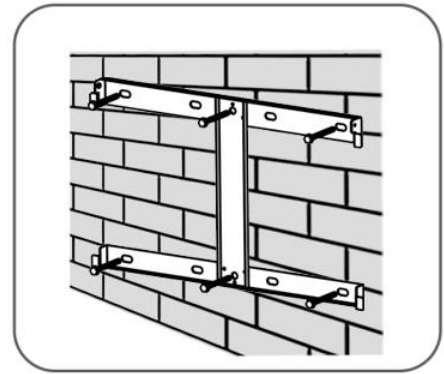

Step 3

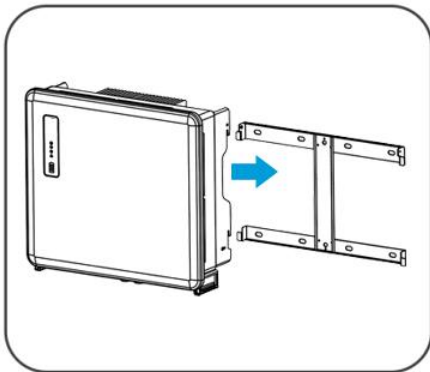

Step 4

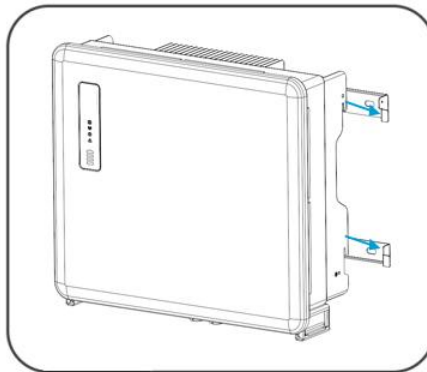

Step 5

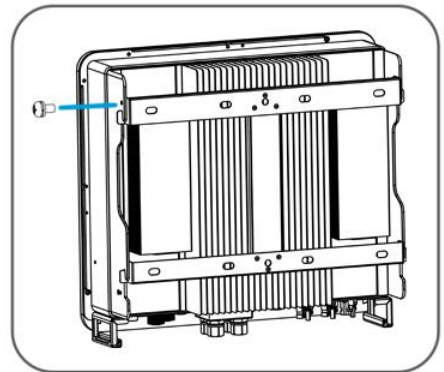

Step 6

## 6. Electrical Connection

### 6.1 Safety Precaution













- All operations, cables and parts specification during the electrical connection shall be in compliance with local laws and regulations.
- Disconnect the DC switch and the AC output switch of the inverter to power off the inverter at least 5 minutes for the capacitor to be electrically discharged before any electrical connections. Do not work with power on. Otherwise, an electric shock may occur.
- Tie the same type cables together, and place them separately from cables of different types. Do not place the cables entangled or crossed.
- If the cable bears too much tension, the connection may be poor. Reserve a certain length of the cable before connecting it to the inverter cable port.
- When crimping the terminals, ensure that the conductor part of the cable is in full contact with the terminals. Do not crimp the cable jacket with the terminal. Otherwise the inverter may not operate, or its terminal block getting damaged due to heating and other phenomenon because of unreliable connection after operation.



- Wear personal protective equipment like safety shoes, safety gloves, and insulating gloves during electrical connections.
- All electrical connections should be performed by qualified professionals.
- Cable colors in this document are for reference only. The cable specifications shall meet local laws and regulations.

## 6.2 Connection Port Description

Connector	Description	Recommend cable type	Recommended Cable specifications	
   	+: Connect the positive electrode of photovoltaic cell -: Connect the negative electrode of photovoltaic cell	Industry common outdoor Photovoltaic cable	Conductor cross-sectional area: 4mm <sup>2</sup> (12AWG)	
 	+: Connect the positive electrode of lithium battery -: Connect the negative electrode of	Outdoor multi-core copper cable	Conductor cross-sectional area: 10mm <sup>2</sup> (7AWG)	
 EPS	EPS(Load)	L1 L2 L3 N PE	Outdoor multi-core copper cable L1/L2/L3: Brown/Red/Green or Yellow Wire N: Blue/Black Wire PE: Yellow & Green Wire	Conductor cross-sectional area: 6mm <sup>2</sup> (10AWG)
 GRID	Grid(AC)	L1 L2 L3 N PE	Outdoor multi-core copper cable L1/L2/L3: Brown/Red/Green or Yellow Wire N: Blue/Black Wire PE: Yellow & Green Wire	Conductor cross-sectional area: 6mm <sup>2</sup> (10AWG)
 GEN	Generator	L1 L2 L3 N PE	Outdoor multi-core copper cable L1/L2/L3: Brown/Red/Green or Yellow Wire N: Blue/Black Wire PE: Yellow & Green Wire	Conductor cross-sectional area: 6mm <sup>2</sup> (10AWG)
 WIFI	WiFi			

## 6.3 PE Cable Connection



- The PE cable connected to the enclosure of the inverter cannot replace the PE cable connected to the AC output port. Both of the two PE cables must be securely connected
- Make sure that all the grounding points on the enclosures are equipotential connected when there are multiple inverters.
- To improve the corrosion resistance of the terminal, it is recommended to apply silica gel or paint on the ground terminal after installing the PE cable.
- Prepare PE cables with the recommended specification:
  - Type: Outdoor single-core copper wire
  - Cross-sectional area:  $6\text{mm}^2(10\text{AWG})$

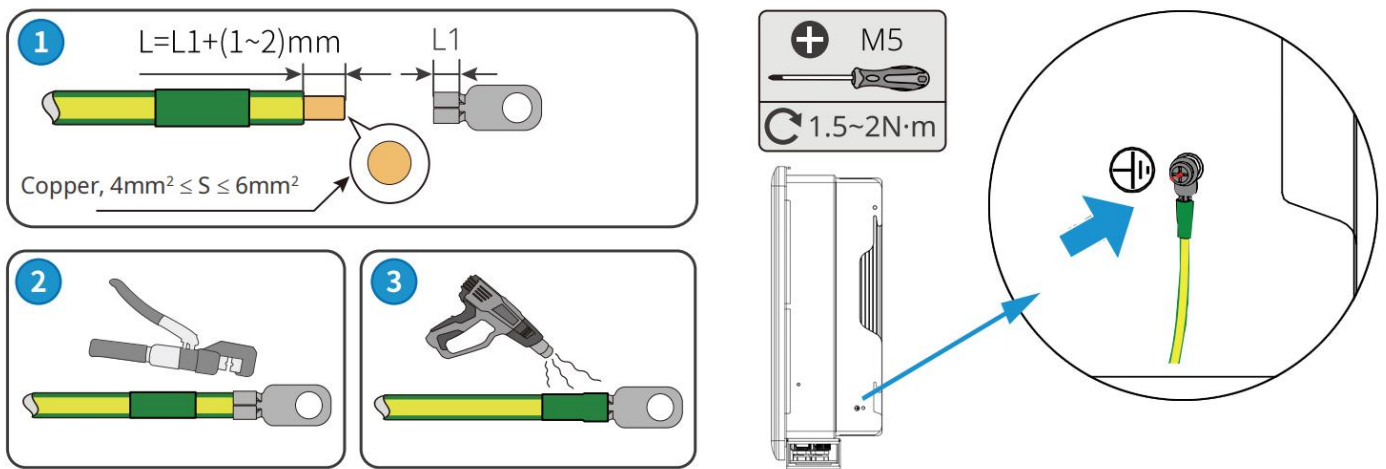

## 6.4 PV Connection

### 6.4.1 PV String Connection



Confirm the following information before connecting the PV string to the inverter. Otherwise, the inverter may be damaged permanently or even cause fire and cause personal and property losses.

1. Make sure that the max short circuit current and the max input voltage per MPPT are within the permissible range.
2. Make sure that the positive pole of the PV string connects to the PV+ of the inverter. And the negative pole of the PV string connects to the PV- of the inverter.

Model for EU	SSE-HH8K-P3EU	SSE-HH10K-P3EU	SSE-HH12K-P3EU
Max. DC Voltage	1000V d.c		
MPPT Voltage Range	150V-950V d.c		

**WARNING**

- 1-Please choose a suitable external DC switch if the inverter does not have a built-in DC switch.
- 2-PV module voltage is very high and within a dangerous voltage range, please comply with the electric safety rules when connecting
- 3-Please **DO NOT** make PV positive or negative to ground.
- 4-PV modules: Please ensure they are the same type, have the same output and specifications,are aligned identically, and are tilted to the same angle. In order to save cable and reduce DC loss, we recommend installing the inverter as near to the PV modules as possible.

**NOTICE**

The DC input cable is prepared by the customer. Recommended specifications:

- Type: the outdoor photovoltaic cable that meets the maximum input voltage of the inverter.
- Conductor cross-sectional area: 2.5~4mm<sup>2</sup> (Devalan) or 4~6mm<sup>2</sup> (MC4).

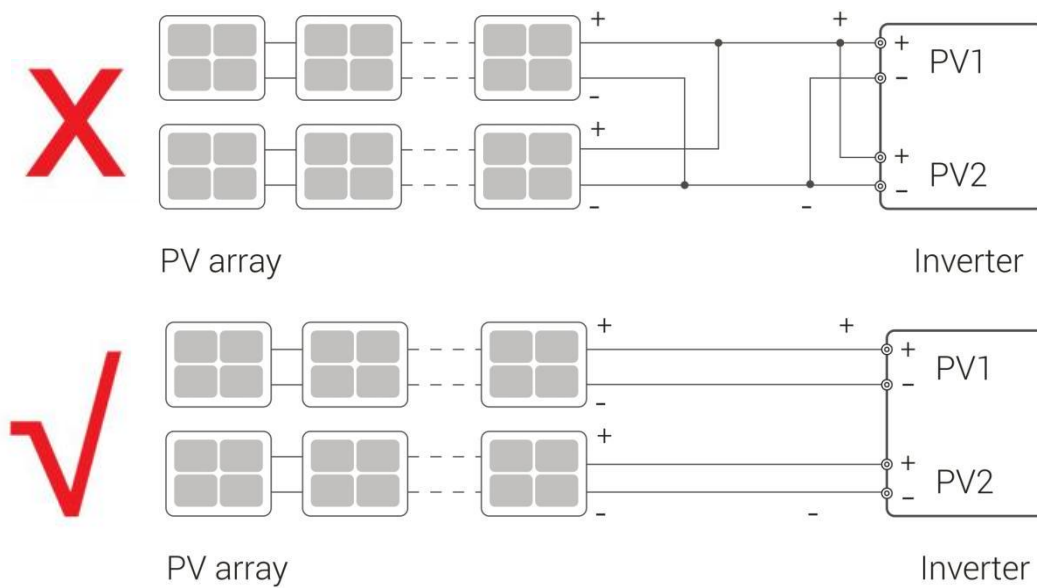

**6.4.2 PV Wiring**

<p><b>Step 1: Inspect PV modules</b></p> <ol style="list-style-type: none"> <li>1. Measure the module array voltage with a voltmeter.</li> <li>2. Check the PV+ and PV- from the PV string combiner box correctly.</li> <li>3. Please make sure the impedance between the positive pole and negative pole of PV to ground should be <math>M\Omega</math> level.</li> </ol>	
	<p><b>Step 2: Separate DC Connector</b></p>

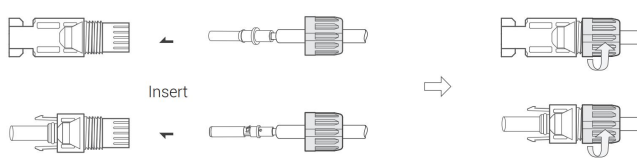
<p><b>Step 3: Wiring</b></p> <ol style="list-style-type: none"> <li>1. Connect the 12 AWG wire to the cold crimp terminal.</li> <li>2. Remove 10mm of insulation from the end of the wire.</li> <li>3. Insert the insulator into the pin contact and clamp it with crimping pliers.</li> </ol>	
	<p><b>Step 4:</b> Insert the pin contact through the nut and into the male or female plug, when a "click" is felt or heard, the pin contact assembly is properly seated. Then tighten the nut.</p>
<p><b>Step 5:</b> Plug the PV connector into the corresponding interface on the inverter.</p>	

## 6.5 EPS and Grid, Generator Connection

### NOTICE

SSE-HH8-12K-P3EU series inverters are designed for three-phase grid. Voltage range is 380/400V/415V; frequency is 50/60Hz. Other technical requests should comply with the requirement of the local public grid.

### WARNING

- A micro-breaker for max output over current protection device shall be installed between inverter and grid, and the current of the protection device is referred to the table above, any load **SHOULD NOT** be connected with the inverter directly.

### NOTICE

Check the grid voltage and compare with the permitted voltage range (refer to technical data).

- Disconnect the circuit-breaker from all the phases and secure against re-connection.
- Trim the wires:
  - Trim all the wires to 52.5mm and the PE wire to 55mm.
  - Use the crimping pliers to trim 12mm of insulation from all wire ends as below.
  - Please refer to local cable type and color for actual installation.
  - Cross-sectional area: 6mm<sup>2</sup>(10AWG)

## 6.5.1 EPS Wiring

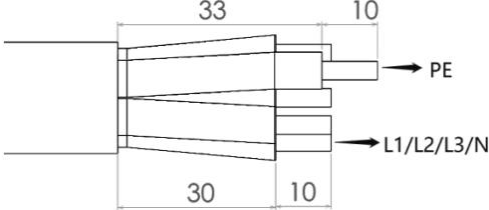
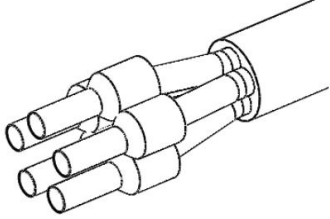
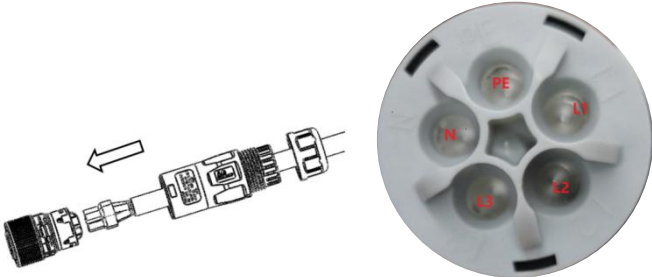
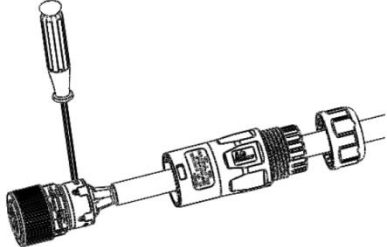
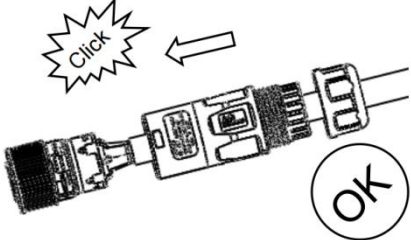
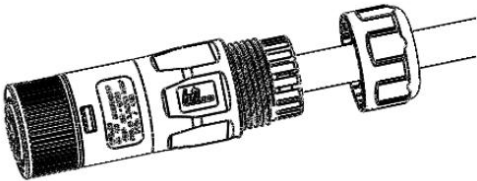
Installation Procedure	
	<p>Step 1:</p> <ul style="list-style-type: none"> <li>• Turn off the DC and battery switch .</li> <li>• Choose 10 AWG wire to connect the EPS port.</li> <li>• Trim 6mm of insulation from the wire end.</li> </ul>
<p>Step 2: Crimp the terminals with crimping pliers</p>	
	<p>Step 3: (Set the parts on the cable, Insert the terminal holes in sequence</p>
<p>Step 4: Crimp the wire with an inner hexagon screwdriver and screw the torque <math>1.2 \pm 0.1 \text{ N} \cdot \text{m}</math></p>	
	<p>Step 5: Insert the main body into the rubber core and hear the "click" sound</p>
<p>Step 6: Tighten the nut with an open-ended wrench (torque <math>2.5 \pm 0.5 \text{ N} \cdot \text{m}</math>)</p>	

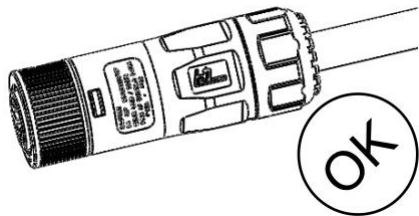

Step 7:  
Female Connector completed

Step 8:  
Find the EPS male connector in the inverter

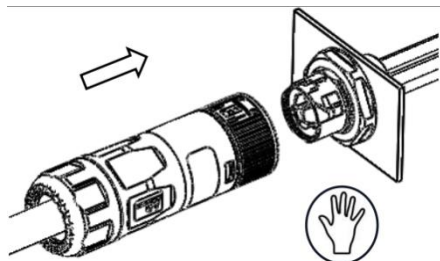
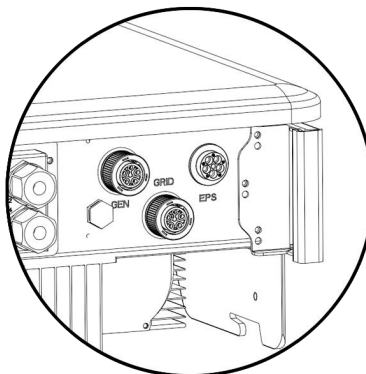

Step 9:  
The installation arrow indicates insertion the EPS female connector

Step 10:  
Complete the installation

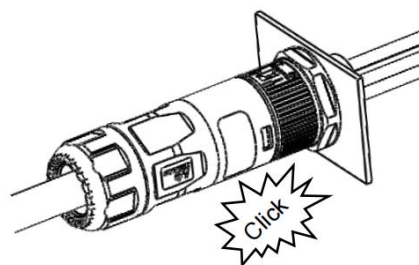

## Unlock instructions

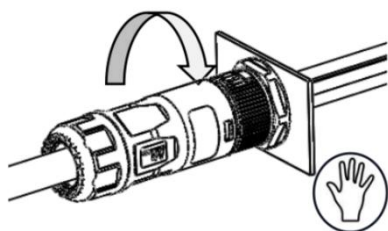

Step 1:  
Rotate the latch as shown

Step 2:  
Pull the male end of the cable is unlocked

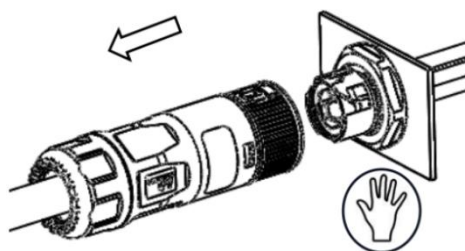



## 6.5.2 GRID and Generator Wiring

SSE-HH8-12K-P3EU series inverters are designed for three-phase grid. The voltage is 380/400V/415V, frequency is 50Hz. Other technical requests should comply with the requirements of the local public grid.

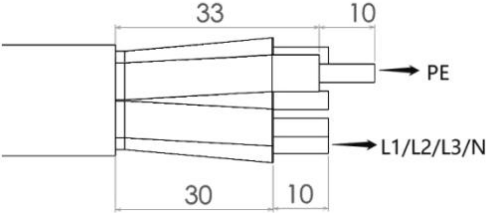
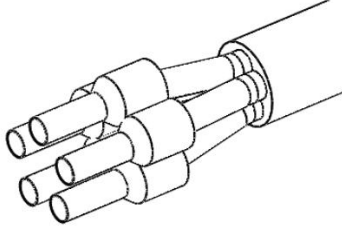
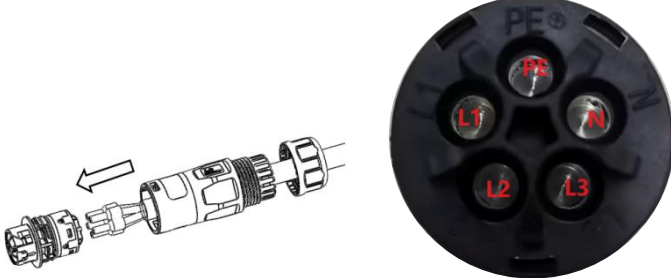
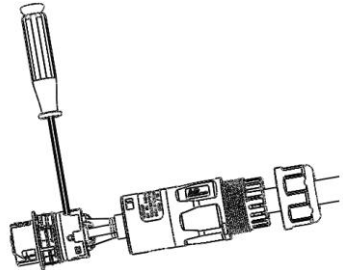
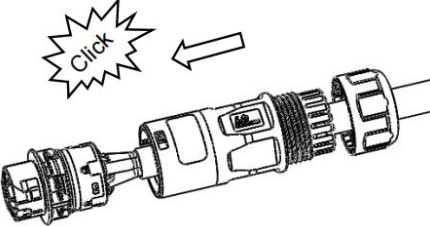
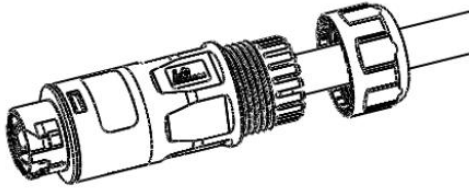
Installation Procedure	
	<p>Step 1:</p> <ul style="list-style-type: none"> <li>• Turn off the DC and battery switch .</li> <li>• Choose 10 AWG wire to connect the GRID port.</li> <li>• Trim 6mm of insulation from the wire end.</li> </ul>
<p>Step 2:</p> <p>Crimp the terminals with crimping pliers</p>	
	<p>Step 3:</p> <p>(Set the parts on the cable, Insert the terminal holes in sequence</p>
<p>Step 4:</p> <p>Crimp the wire with an inner hexagon screwdriver and screw the torque <math>1.2 \pm 0.1 \text{ N} \cdot \text{m}</math></p>	
	<p>Step 5:</p> <p>Insert the main body into the rubber core and hear the "click" sound</p>
<p>Step 6:</p> <p>Tighten the nut with an open-ended wrench (torque <math>2.5 \pm 0.5 \text{ N} \cdot \text{m}</math>)</p>	

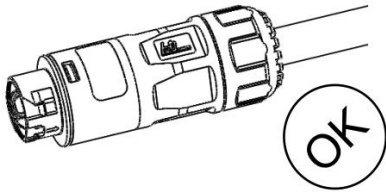
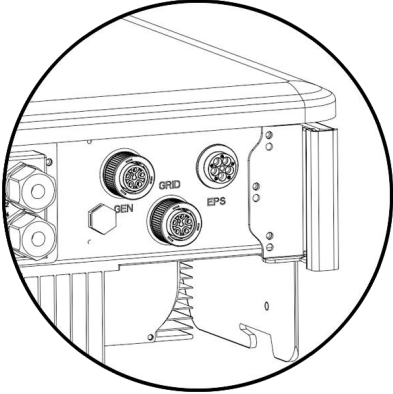
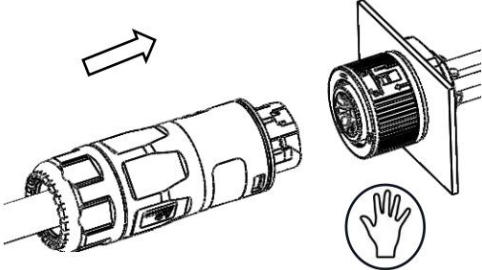
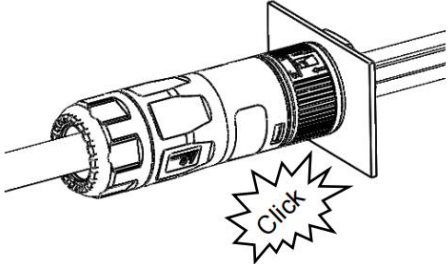
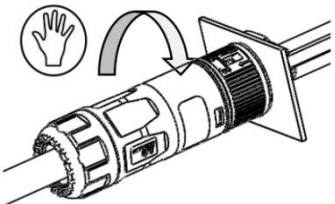
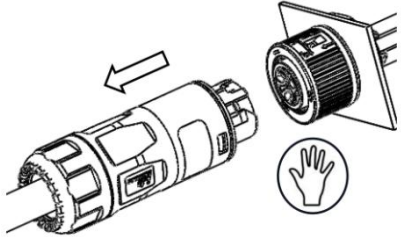
	<p>Step 7: Male Connector completed</p>
<p>Step 8: Find the GRID or GEN male connector in the inverter</p>	
	<p>Step 9: The installation arrow indicates insertion the GRID or GEN male connector</p>
<p>Step 10: Complete the installation</p>	
<p><b>Unlock instructions</b></p>	
	<p>Step 1: Rotate the latch as shown</p>
<p>Step 2: Pull the male end of the cable is unlocked</p>	

## 6.6 Battery Connection

### DANGER

- The battery used with the inverter shall be approved by the inverter manufacturer. The approved battery list can be obtained through the official website.
- A short circuit in the battery may cause personal injury. The instantaneous high current caused by a short circuit can release a large amount of energy and may cause a fire.
- Before connecting the battery cable, ensure the inverter and the battery, and downstream&upstream switches, are all disconnected.
- It is forbidden to connect and disconnect the battery cables when the inverter is running. Otherwise it may cause electric shock.
- Do not connect one battery pack to more than one inverter at the same time. Otherwise, it may cause damage to the inverter.
- It is forbidden to connect loads between the inverter and batteries.
- When connecting battery cables, use insulated tools to prevent accidental electric shock or short circuit to the batteries.
- Ensure that the open circuit voltage of the battery is within the permissible range of the inverter.
- **Install a DC switch between the inverter and the battery**

### WARNING

- Connect the battery cables to the corresponding terminals such BAT+, BAT- and grounding ports correctly. Otherwise it will cause damage to the inverter.
- Ensure that the whole cable cores are inserted into the terminal holes. No part of the cable core can be exposed.
- Ensure that the cables are connected securely. Otherwise it will cause damage to the inverter due to overheat during its operation.
- Servicing of batteries should be performed or supervised by personnel knowledgeable about batteries and the required precautions.
- When replacing batteries, replace with the same type and number of batteries or battery packs.
- CAUTION: Do not dispose of batteries in a fire. The batteries may explode.
- CAUTION: Do not open or damage batteries. Released electrolyte is harmful to the skin and eyes. It may be toxic.
- CAUTION: A battery can present a risk of electrical shock and high short-circuit current. The following precautions should be observed when working on batteries:
  - a) Remove watches, rings, or other metal objects.
  - b) Use tools with insulated handles.
  - c) Wear rubber gloves and boots.
  - d) Do not lay tools or metal parts on top of batteries.
  - e) Disconnect charging source prior to connecting or disconnecting battery terminals.
  - f) Determine if battery is inadvertently grounded. If inadvertently grounded, remove source from ground. Contact with any part of a grounded battery can result in electrical shock. The likelihood of such shock can be reduced if such grounds are removed during installation and maintenance (applicable to equipment and remote battery supplies not having a grounded supply circuit)

### NOTICE

#### **Battery breaker**

Before connecting to the battery, install a non-polarized DC circuit breaker to ensure that the inverter can be safely disconnected during maintenance.

## Connection steps:

### Step 1:

- Turn off the DC switch.
- Choose 7 AWG wire to connect the battery.
- Trim 6mm of insulation from the wire end.

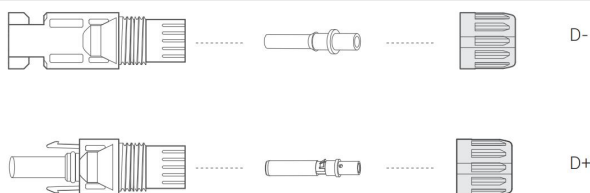

### Step 2:

Separate the DC connector (battery) as below.

### Step 3: Wiring

1. Connect the 7 AWG wire to the cold crimp terminal.
2. Remove 10mm of insulation from the end of the wire.
3. Insert the insulator into the pin contact and clamp it with crimping pliers.

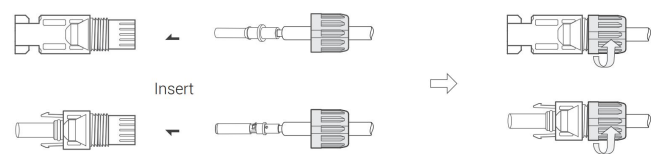
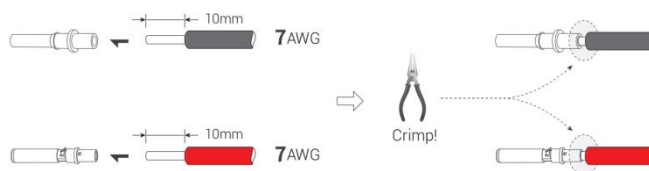

Step 4: Insert the pin contact through the nut and into the male or female plug, when a "click" is felt or heard, the pin contact assembly is properly seated. Then tighten the nut.

Step 5: Plug the BAT connector into the corresponding interface on the inverter.

## 6.7 Communication Cable Installation

### NOTICE

The SSE-HH8-12K-P3EU series inverter are available with multiple communication options such as WiFi, Bluetooth, RS485 and Meter with an external device.

Operating information like output voltage, current, frequency, fault information, etc., can be monitored locally or remotely and cellphone App via these interfaces.

### 6.7.1 Protective Cover for Communication Ports

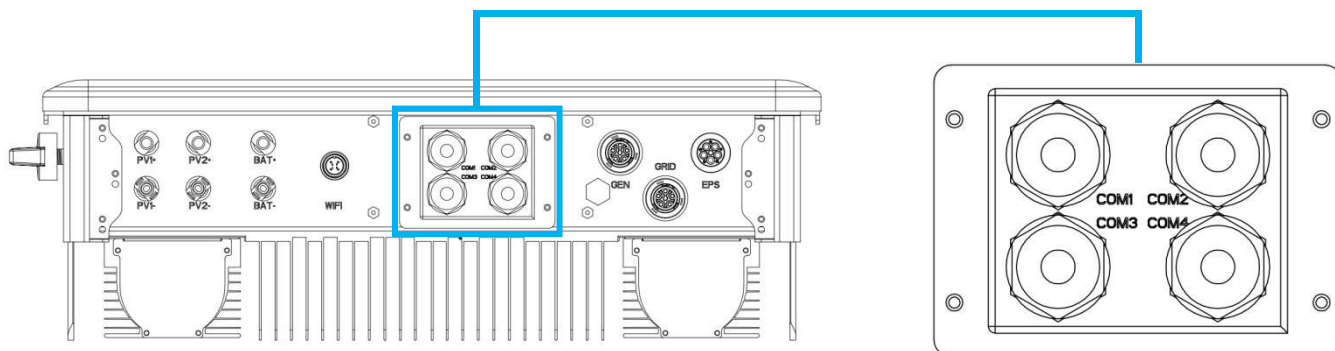

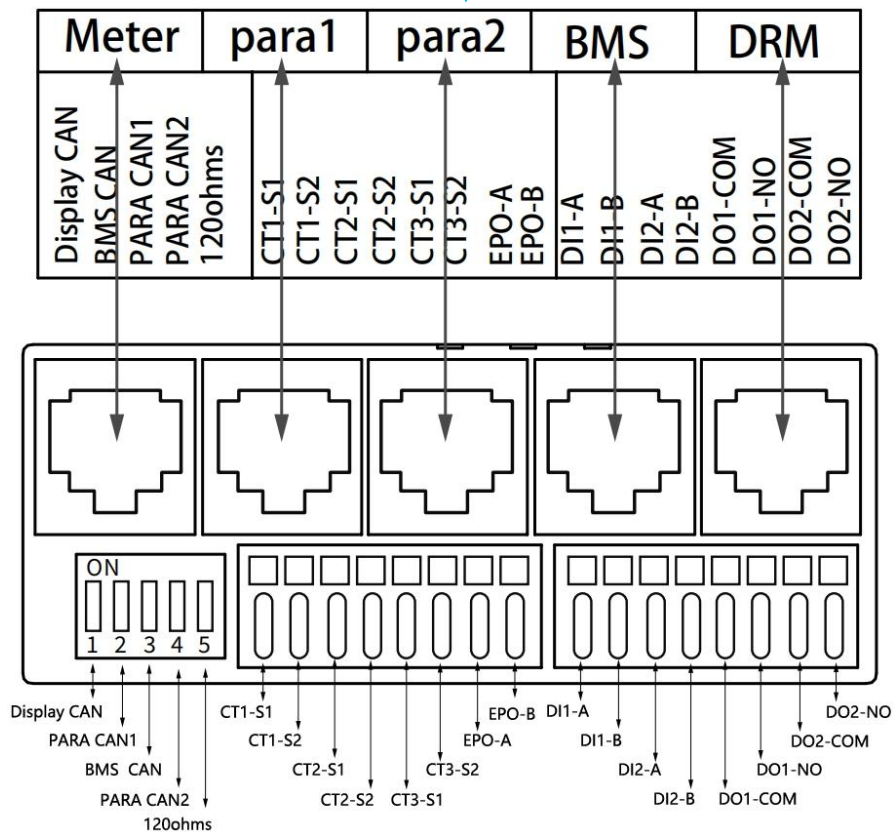
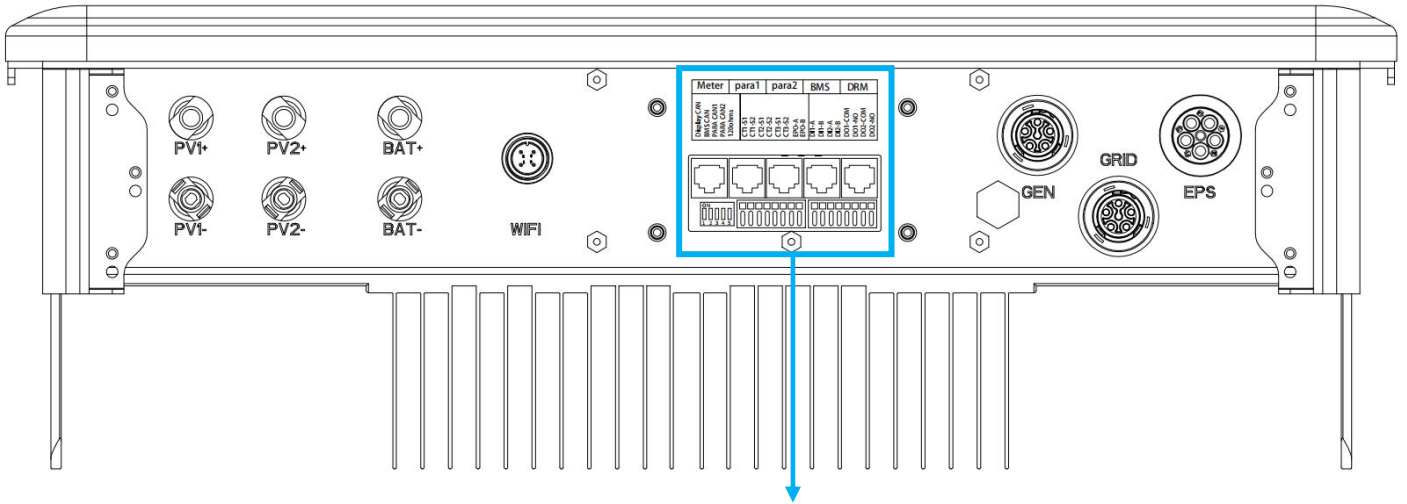

Inverter in the package is with a protective cover assembled to protect the communication ports.

Step 1. Use screwdriver to take out the 4 screws on the cover.

Step 2. Read through the following sections of the manual and prepare the internet cables correspondingly.

Step 3. Loose the cable gland and remove the watertight caps inside the cable gland based on the number of the cables and keep the unused holes with watertight cap.

Step 4. Lead the cables into the holes in the cable gland. (Hole Diameter: 6mm)

Step 5. Crimp the RJ45 connectors onto the cables according to the pin definitions described in the following sections and connect to the ports accordingly.

Step 6. Fasten the 4 screws on the cover (Torque: 1.7N.m-2 N.m)

Step 7. Reassemble the cable gland and ensure there is no bending or stretching of the internet cables inside the cover.

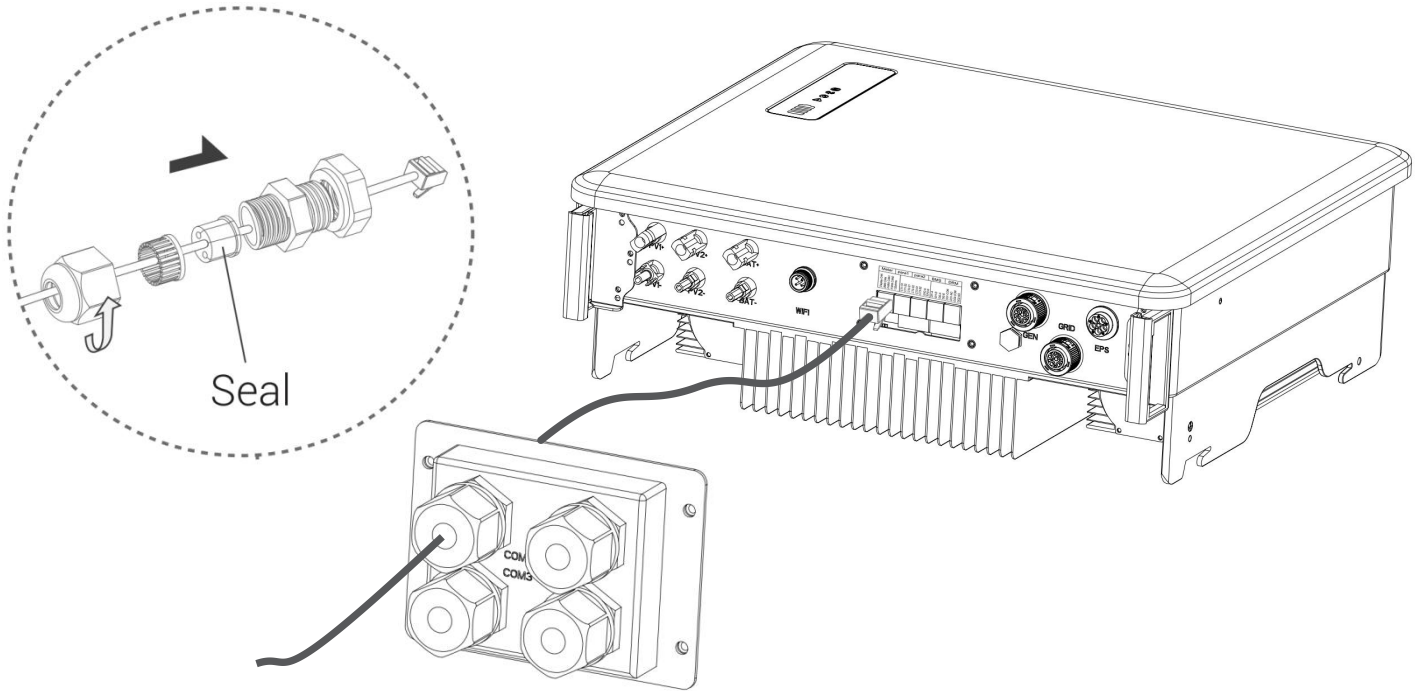

PIN	Meter	BMS RJ45	PARA1/2	DRM
1	Meter RS485A	Lead-acid cell NTC	Para Display CAN_H	GND
2	Meter RS485B	GND	Para Display CAN_L	DRM1/5
3	/	/	/	DRM2/6
4	5V_VCC	BMS_CAN1_H	Para Power CAN1_H	DRM3/7
5	FR_ALM_IN	BMS_CAN1_L	Para Power CAN1_L	DRM4/8
6	5V_GND	GND	/	DRM0
7	AFCI_485A	BMS_485A	Para Power CAN2_H	GND
8	AFCI_485B	BMS_485B	Para Power CAN2_L	GND

**RJ45terminal**

T568B

RJ45 plug 1--8

## 6.8 Wi-Fi&BLE stick installation

### 6.8.1 Indication

A: Circular Connector Interface: Connect to inverter and communication

B: Red LED: Inverter communication indication

C: Green LED: Network communication indication

D: Product label: Show product information

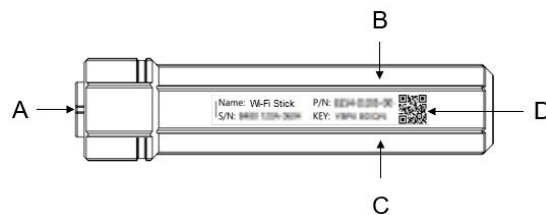

1. LED glow only when the Wi-Fi&BLE stick is powered on.
2. When the Wi-Fi&BLE stick is powered on, the green LED glows for 3S as a power on indication.
3. The more detail LED indication please refer chapter 9 "LED indication and trouble shooting".

### 6.8.2 Install the Wi-Fi&BLE stick

Follow the installation steps!

1. Remove the waterproof cover.	2. Aligning groove.
3. Plug in WiFi module.	4. Revolve to lock the WiFi module.

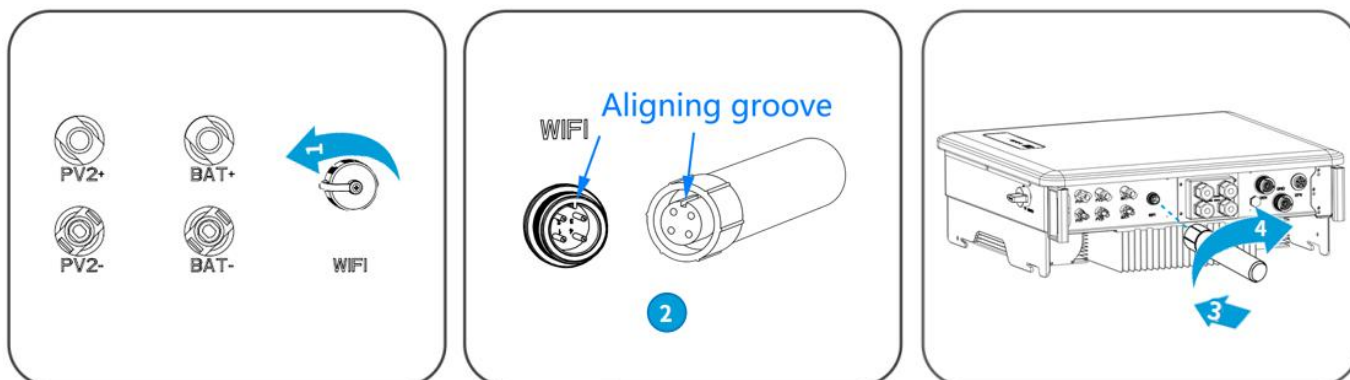

### 6.8.3 Web/APP

Item	Web View	APP	SOSEN Energy Web&APP manual
QR Code			
Website	<a href="https://sosen.inteless.com/">https://sosen.inteless.com/</a>	iOS: search "SOSEN Energy" in Apple Store Android: search "SOSEN Energy" in Google Play	<a href="https://www.sosencx.com/download.html">https://www.sosencx.com/download.html</a>



## 6.8.4 Wi-Fi Connection











The Wi-Fi connection diagram of Wi-Fi&BLE stick is shown in the figure below. The specific process can be downloaded the APP, and configure the network connection according to the operation guide of the APP.



## 6.8.5 Installation qualification

If the Wi-Fi&BLE stick works normally, red LED and green LED are always glowing. Otherwise, it needs to be corrected by referring to chapter 9 “LED indication and trouble shooting”

## 6.8.6 LED indication and trouble shooting

LED	State	Indication	
	Red LED:Inverter communication indication		Green LED:Network communication indication
	Cycle for 2S: flash once quickly, then glowing	Cycle for 2S: flash once quickly, then glowing	
	Not glow more than 20S	The power supply to the Wi-Fi&BLE stick is abnormal or damaged: 1. Check whether the power supply of the Aerial Plug Interface on the inverter is normal 2. Wi-Fi&BLE stick abnormal, contact the dealer	
	Cycle for 2S: flash once quickly, then off	Communication failure: Check whether the connection between the Wi-Fi&BLE stick and inverter is loose or poor contact	
	When powered on, continuously glows 3S, and then off	Power on indication	
	Glow more than 5S	Communication is normal	
	During the long glowing, flash occasionally	Network transmit data	
	Cycle for 20S: flash once quickly, then off	The route is not connected: 1. Check whether the password is right 2. Check the strength of the router	
	Cycle for 20S: flash 3 times continuously, then off	Connect to the route, but can't connect to the cloud server: 1. Check whether the router has Internet access permission 2. Check the firewall setting	
	Cycle for 20S: flash 4 times continuously, then off	Wi-Fi&BLE stick information error: Please contact the dealer	



## 7.Operation

### 7.1 Indicator panel



Name	Object	Function
Indicator LED	A	Green : ON, The inverter is running ; Flash is Standby.
	B	Blue : ON, Communication with BMS normal.
	C	Yellow : ON, The inverter is in EPS mode.
	D	Red : The inverter is in fault mode.
	E	Green : ON , battery capacity is 90~100%.
	F	Green : ON , battery capacity is 61~89%.
	G	Green : ON , battery capacity is 35~60%.
	H	Green : ON , battery capacity is 10~34%.

## 8.Trouble Shooting

This section contains information and procedures for solving possible problems with the SSE-HH8-12K-P3EU series inverters, and provides you with trouble shooting tips to identify and solve most problems that could occur with the SSE-HH8-12K-P3EU series inverters.

This section will help you narrow down the source of any problems you may encounter. Please read the following trouble' shooting steps.

Check the warning or fault messages on the System Control Panel or Fault codes on the inverter information panel. If a message is displayed, record it before doing anything further. Attempt the solution indicated in below table.

<b>Fault Code</b>	<b>Solution</b>
grid over frequency alarm	If there is an occasional alarm, it may be that the power grid is occasionally abnormal, and after the power grid is restored to normal, the inverter will automatically return to normal working state. If the alarm is frequent, check whether the grid voltage/frequency is set correctly, as well as the inverter's AC circuit breaker and AC wiring. If the check is correct and the alarm is still repeated, contact technical support
grid under frequency alarm	
grid overvoltage alarm	
grid undervoltage alarm	
grid long time OV alarm	If the power grid is abnormal, the inverter automatically returns to the normal working state after the power grid recovers.Or seek help from us, if not go back to normal state.
grid amplitude fast inspection alarm	
grid DC component fast detection alarm	
grid phase fast inspection alarm	
overload protection	If the load power is too large or the device derates, reduce the power consumption. Or seek help from us, if not go back to normal state.
overload alarm	
CT reverse connect failure	Check whether the CT connection is correct.
CT fault	
Ground fault	Check whether the PE cable is grounded properly.
grid phase deficiency alarm	Check whether the AC input cable is correctly connected.
LN reverse connect failure	
grid phase abnormal alarm	
INV overvoltage fault	The inverter is faulty. Procedure Turn off the PV, grid, and battery, and wait 5 minutes before turning on the inverter. Check whether the problem is resolved.Or seek help from us, if not go back to normal state.
INV undervoltage fault	
Leakage current self-test failure	
Short circuit fault	
INV overcurrent protection	
INV bus overvoltage protection	
INV bus undervoltage protection	
Bus unbalance alarm	
Relay self-test failure	
INV fault lock	
Busbar buffer failure	
INV phase lock fault	
Internal para matching fail	
aux power fault	
fan fault	
DC fault lock	
DC bus overvolt protection	
DC bus undervolt protection	
Leakage current overlimit fault	
PV1 overcurrent protection	
PV2 overcurrent protection	
INV FLASH fault	The internal communication and storage are abnormal. Turn off the PV, grid, and battery, and wait 5 minutes before turning on the inverter. Check whether the problem is resolved.Or seek help from us, if not go back to normal state.
INV-DC comm fault	
ARM-INV comm fault	
ARM-DCDC comm fault	
power module para mis-matched	
power parameter set failure	
ARM FLASH abnormal	
DC-INV comm fault	
DC FLASH fault	
host fault	Turn off the host PV, power grid, and battery, and wait 5 minutes before turning on the inverter. Check whether the problem is resolved.Or seek help from us, if not go back to normal state.
Parallel para mismatch fault	Check whether the parallel communication cable is properly connected.
Parallel line failure	
discharge OC protection	Check whether the battery Settings are inconsistent with the battery specifications.
charge OC protection	
DC BAT overvoltage protection	
DC BAT undervoltage protection	
BAT reverse connect failure	Check whether the positive and negative terminals of the battery power line are connected in reverse mode.
DC over-temp alarm	Ensure that the inverter is installed in a place without direct sunlight. Make sure the inverter is installed in a cool/well-ventilated area. Ensure that the inverter is installed vertically and the ambient temperature is lower than the upper limit of the inverter temperature.
DC over-temp fault	
INV overtemperature protection	

INV overtemperature alarm	
meter comm fault	Check whether the meter communication line is normal.
BMS-CAN comm abnormal	Make sure the battery you use is compatible with the inverter. Check whether the communication cables or ports between the battery and the inverter are properly connected
BMS-485 Comm abnormal	
NTC disconnected	Check whether cables to the NTC temperature sensor are properly connected.
PV1 overvoltage protection	Check whether the PV string voltage (Voc) is higher than the maximum input voltage of the inverter. If so, adjust the number of series PV modules and reduce the PV string voltage to fit the input voltage range of the inverter. After correction, the inverter will automatically return to the normal state.
PV2 overvoltage protection	
PV1 reverse connect protection	Check whether the PV cables are correctly connected.
PV2 reverse connect protection	
DC BAT overvoltage alarm	The inverter does not detect the battery voltage. Ensure that the battery switch system is started and cables are properly connected.
DC BAT undervoltage alarm	
BAT none-connected	
SOC low alarm	If the battery is low, replenish the battery in time.
BAT ch&disch prohibition	If the internal fault of the lithium battery occurs, Turn off the PV, grid, and battery, and wait 5 minutes to turn on the inverter and lithium battery. Check whether the problem is resolved. Or seek help from us, if not go back to normal state.
Bat general fault	
Bat over-volt fault	
Bat under-volt fault	
Bat high-temp protection	
Bat low-temp protection	
Bat disch over-curr protection	
Bat charge over-curr protection	
Bat contactor fault	
Bat short circuit	
BMS fault	
Bat cell protection	
Bat EOL	
Bat general warning	If the internal fault of the lithium battery occurs, Turn off the PV, grid, and battery, and wait 5 minutes to turn on the inverter and lithium battery. Check whether the problem is resolved. Or seek help from us, if not go back to normal state.
Bat high-volt warning	
Bat low-volt warning	
Bat high-temp warning	
Bat low-temp warning	
Bat disch over-curr warning	
Bat charge over-curr warning	
Bat contactor warning	
Bat short circuit warning	
BMS internal warning	
Bat cell warning	

 **NOTICE**

If your inverters information panel is not displaying a Fault light, check the following list to make sure that the present state of the installation allows proper operation of the unit.

Is the inverter located in a clean, dry, and adequately ventilated place?

Have the DC input breakers been opened?

Are the cables adequately sized and short enough?

Are the input and output connections and wiring in good condition?

Are the configurations settings correct for your particular installation?

Are the display panel and the communications cable properly connected and undamaged?

Contact SOSEN INNOVATION Customer Service for further assistance. Please be prepared to describe details of your system installation and provide the model and serial number of the unit.

## 9.Maintenance

### 9.1 Power Off the Inverter



- Power off the inverter before operations and maintenance. Otherwise, the inverter may shocks or occur.
- Delayed discharge. Wait until the components are discharged after power off.

Step 1: Turn off the AC breaker on the ON-GRID side of the inverter.

Step 2: Turn off the AC breaker on the BACK-UP side of the inverter.

Step 3: Turn off the battery breaker between the inverter and the battery.

Step 4: Turn off the PV switch of the inverter.

### 9.2 Removing the Inverter



- Make sure that the inverter is powered off.
- Wear proper PPE before any operations.

Step 1: Disconnect all the cables, including DC cables, AC cables, communication cables, the communication module, and PE cables.

Step 2: Remove the inverter from the mounting plate.

Step 3: Remove the mounting plate.

Step 4: Store the inverter properly. If the inverter needs to be used later, ensure that the storage conditions meet the requirements.

### 9.3 Disposing of the Inverter

If the inverter cannot work anymore, dispose of it according to the local disposal requirements, The inverter cannot be disposed of together with household waste.



- Make sure that the inverter is powered off.
- Wear proper PPE before any operations.

### 9.4 Routine Maintenance

Maintaining Item	Maintaining Method	Maintaining Period
System Clean	Check the heat sink, air intake, and air outlet for foreign matter or dust.	Once 6-12 months
PV Switch	Turn the DC switch on and off ten consecutive times to make sure that it is working properly.	Once a year
Electrical Connection	Check whether the cables are securely connected. Check whether the cables are broken or whether there is any exposed copper core.	Once 6-12 months
Sealing	Check whether all the terminals and ports are properly sealed. Reseal the cable hole if it is not sealed or too big.	Once a year