



MANUFACTURER: Shenzhen Gosens Photoelectric co.,ltd.
PHONE: 0755-36631393
ADDRESS: East Block, 3rd Floor, No.28, Xinde Industrial North District, Fuhai Street,
Fuyong Town, Bao'an District, Shenzhen, Guangdong
URL: <https://www.ledgxs.com/>



PRODUCT BROCHURE

GOSENS PHOTOELECTRIC

HIGH COLOR RENDERING/NEON/ADDRESSABLE/COB

THE ENTERPRISE CULTURE
企业文化

HIGH CRI/GENERAL LIGHT SERIES

高显/通用灯带系列

COB LED STRIP SERIES

COB灯带系列

ADDRESSABLE LED STRIP SERIES

可寻址灯带系列

SEVEN COLOR RGB LIGHT STRIP SERIES

七彩RGB灯带系列

NEON LED STRIP SERIES

霓虹灯带系列

Company Profile	1	Color development performance	13	Comparison of conventional and COB light strips	55	Addressable light strip solution	79	Colorful RGB light strip list	115	Application Scenario	129
System Certification	3	Light source spectrum test	15	Scenario	57	Luminous Effect	81	RGB series	118	Neon Strip solution	131
Product Series	5	Color Application Guide	19	Luminous Effect	58	Scenario Application	83	RGBW series	122	Protection technology	133
Application Scenario	7	CRI /Universal light strip solution	21	COB light belt solution	59	Addressable light band classification	85			Neon light installation scheme	135
		Protection process	23	Recommended Connector	60	List of addressable light bands	87			Neon strip classification	137
		CRI light strip installation mode	24	COB light strip list	61	Series 2811	89			Neon strip list	139
		CRI light strip classification	27	COB light belt classification	63	Series 2812	92			Front Luminescence	141
		Color/Color temperature	28	COB monochrome Series	64	Series 2813	99			Side Luminescence	151
		CRI light strip list	31	COB two-color temperature series	70	Series 2815	103			Three sides glow	157
		Monochrome Series	33	COB - RGB series	74	Series 2818	107			360° full luminescence	167
		Dual color temperature series	45			Series 2020	111				
		No drop Series	49								

Company introduction



"Bringing light closer to natural light" (Shenzhen Gaoxianse Photoelectric Co.,LTD) is a company focusing on high colour rendering LED lighting, high display lamps and lanterns, light strips, research and development, production, sales, focusing on light quality. Our company's products are characterised by clearer light and truer colors. The company is committed to promoting "Be closer to natural light" to create a clearer and healthier light environment. We value the valuable suggestions of every user and promote the continuous improvement civilisation in the lighting industry.



Product system

From lamp bead packaging, soft and hard board light source components to arbitrary modeling of neon products, linear lighting system, track lighting system, to meet the personalized needs of space lighting design.



HIGH CRI/GENERAL LIGHT SERIES



COB LED STRIP SERIES



SEVEN COLOR RGB LIGHT STRIP SERIES



TWO-COLOR TEMPERATURE SERIES



ADDRESSABLE LED STRIP SERIES



NEON LED STRIP SERIES



Manufacturing base

Baoan District industrial base, with a full set of automatic SMT machine, stable quality, strong production capacity, strong delivery capacity.



Certification system

The company adheres to independent research and development, continuous innovation, through the national ISO9001 quality system certification, and obtained a number of design patents. All products have been tested by the third-party authoritative laboratory institutions, and obtained the quality certification of various countries and regions: CE, ROHS, etc.





HIGH CRI SERIES

A light source with a high color rendering index (Ra) should be used to correctly represent the original color of the substance. Its value is close to 100, and the color rendering is the best. The color display of LED, simply speaking, is close to the spectrum of sunlight, through the ratio of different phosphors, try to simulate the spectrum of sunlight.



COB LED STRIP SERIES

Due to the structural characteristics of COB strip, the luminous surface is a linear colloid. COB chip directly solidified on the PCB, the heat of the chip can be quickly transferred to the PCB. Therefore, the chip heat dissipation rate of THE COB lamp strip is faster than that of the lamp bead lamp, and the light decline of the COB lamp strip is smaller and the life is longer; The luminous Angle of COB lamp strip can reach 180° .



ADDRESSABLE LED STRIP SERIES

Magic lamp belt is a kind of color lamp belt composed of a variety of color beads, can be achieved through the controller to change the combination of different colors, showing different running horse lamp, water lamp effect. Generally applicable to bars, KTV, stage and other places. More commonly used addressable LED strip is with 5050, WS2801, WS2812, WS2813, WS2815 and WS2818.

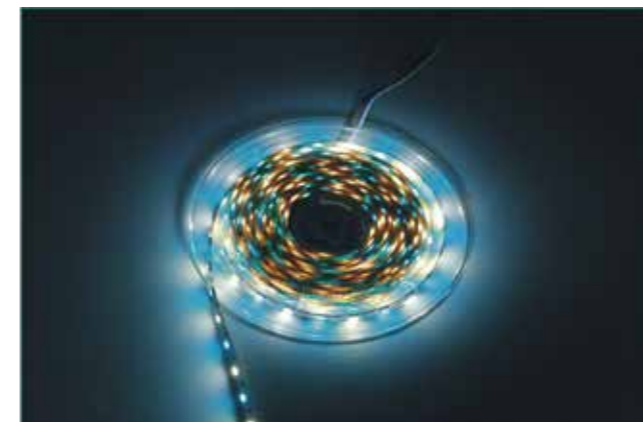

SEVEN COLOR RGB LIGHT STRIP SERIES

RGB light belt means that each LED welded on the LED light belt is composed of three chips: red, green and blue. They can emit three monochromatic lights, such as red, green and blue, alone, or they can emit three chips together and combine them into white light. Blue + red, blue + green, red + green can be combined according to the needs, respectively, showing three colors: purple, green and yellow.



NEON LED STRIP SERIES

The silicone neon lamp belt adopts the two-color silicone one extrusion forming process to produce the protection grade of IP67/IP68, with salt resistance, acid and alkali, gas corrosion prevention, fire prevention, UV resistance; Can be widely used in indoor and outdoor modeling design, walk, eaves corner and other places, play a decorative lighting effect.





HIGH CRI/GENERAL LIGHT SERIES

Can correctly represent the original color of the substance
Use a light source with a high color rendering index (Ra).
Its value is close to 100, the best color

Color development performance

FULL SPECTRUM TM -30-15 TEST

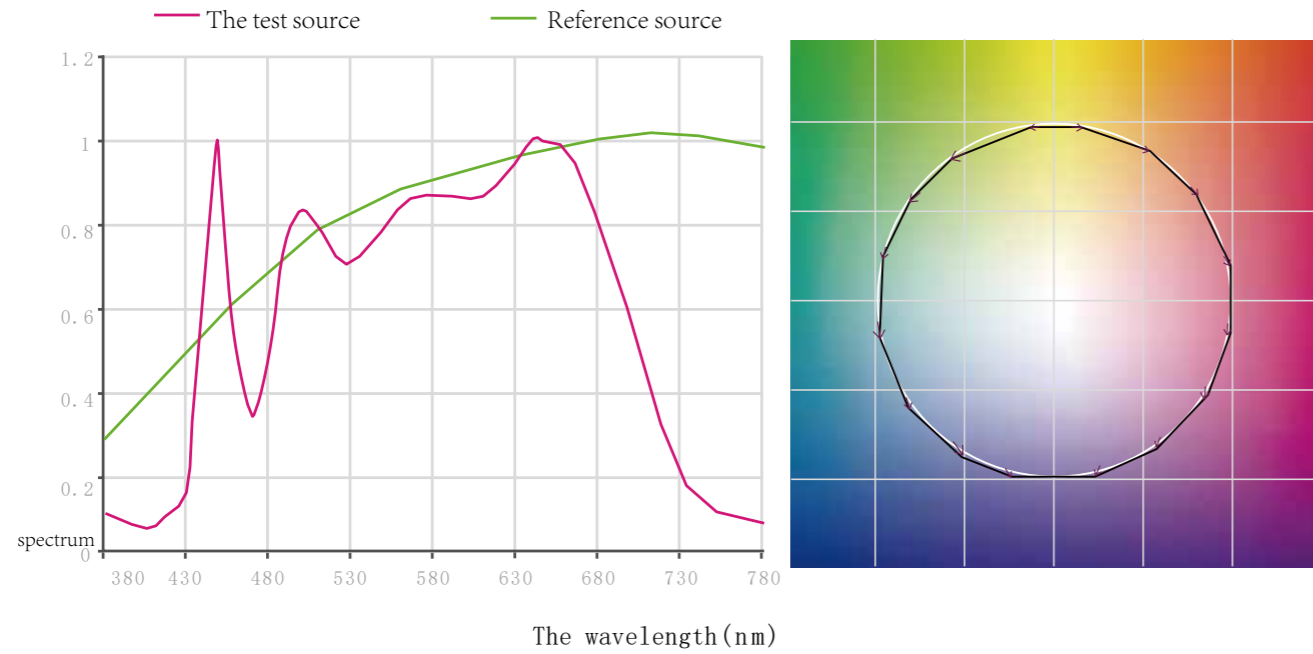

HIGH COLOR RENDERING INDEX MEAN CRI EVALUATION INDEX

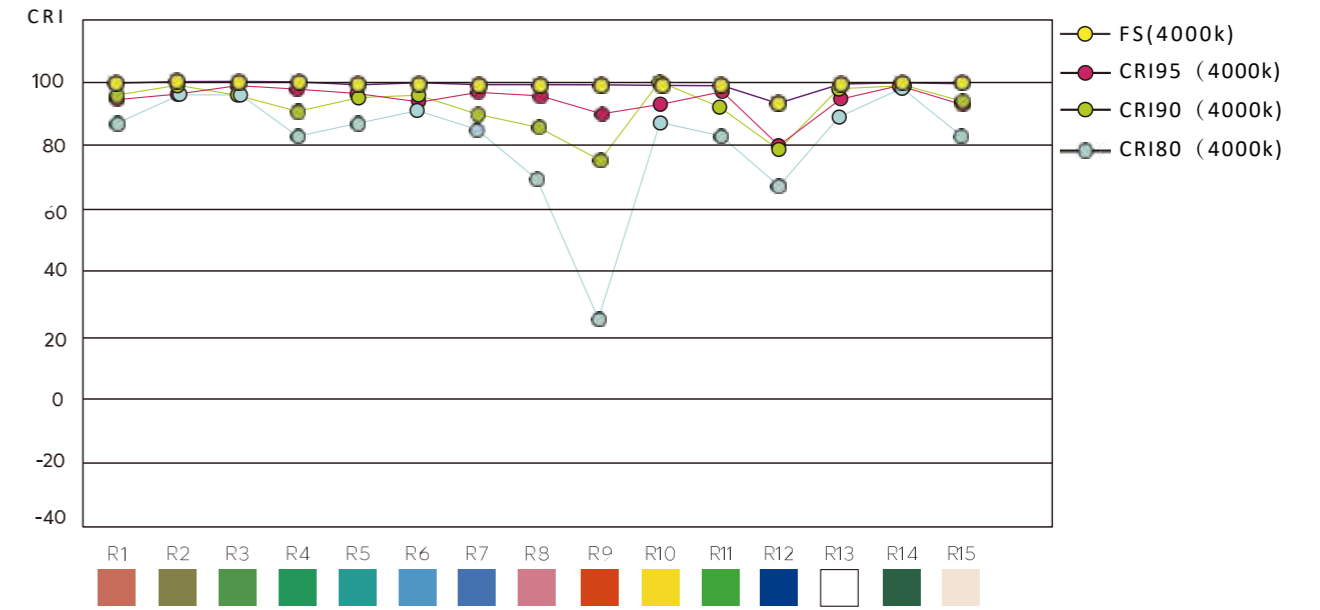

CRI CONTRAST

Index (Ra) grade color rendering for general applications

- 90 -- 100 1A excellent places that require accurate color contrast
- 80 -- 89 1B/Places where correct color judgment is required
- 2 General need for medium color properties of the place
- 40-59 3 / Lower requirements for color development, small color difference place
- 20 -- 39 4 poor color rendering without specific requirements

Using CRI>95, the color restoration degree is closer to natural light



Rf by Hue

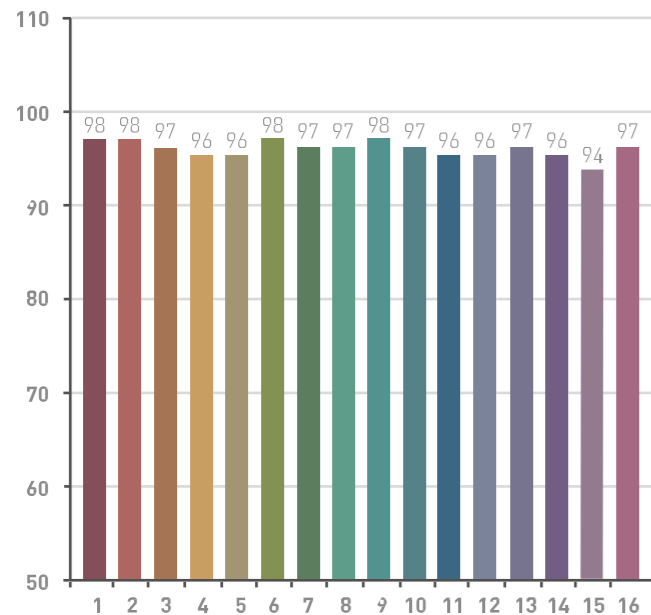

Rg

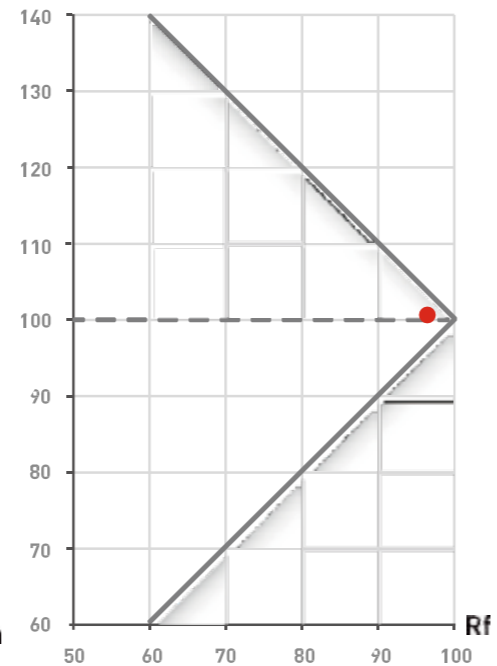

Light source spectrum test

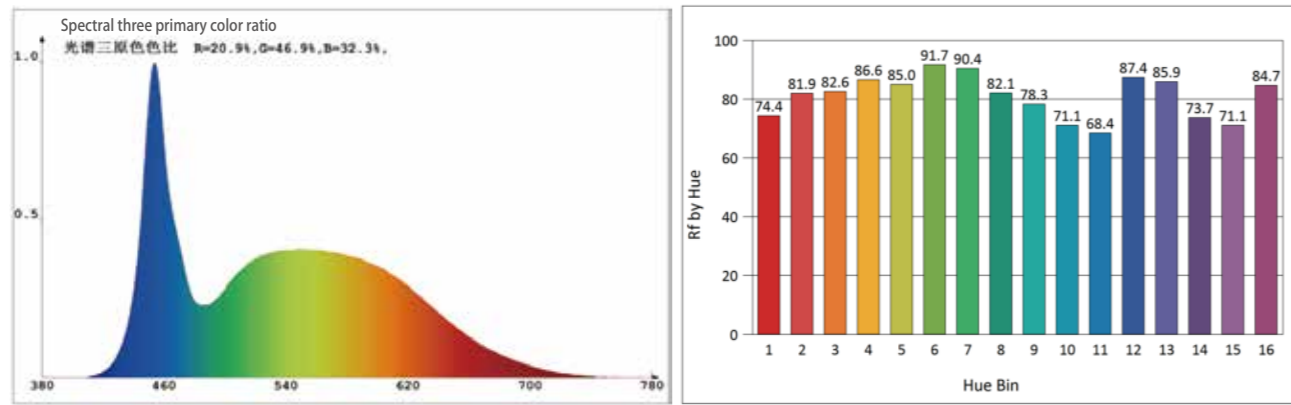

CRI>95, Color temperature: 6500K

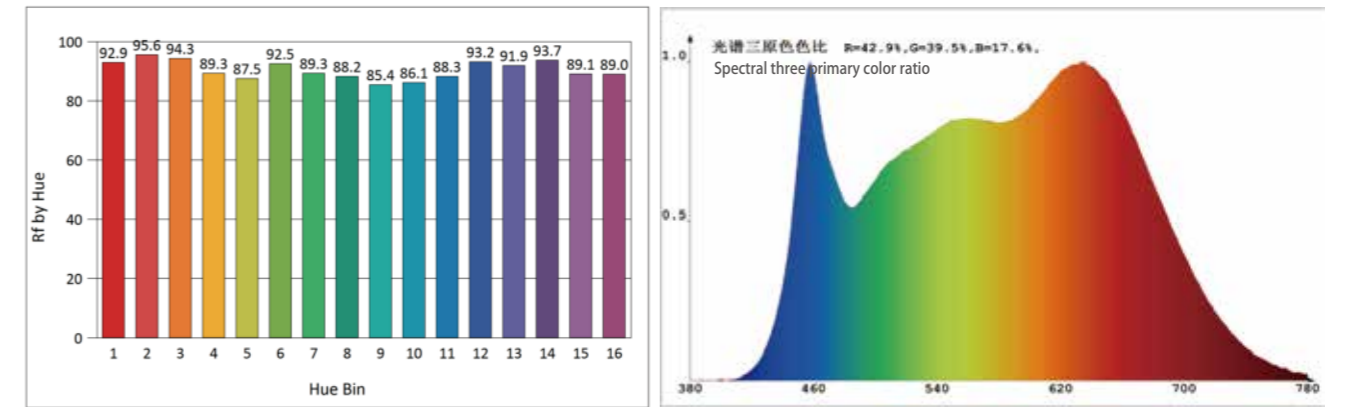

CRI>95, Color temperature: 4000K

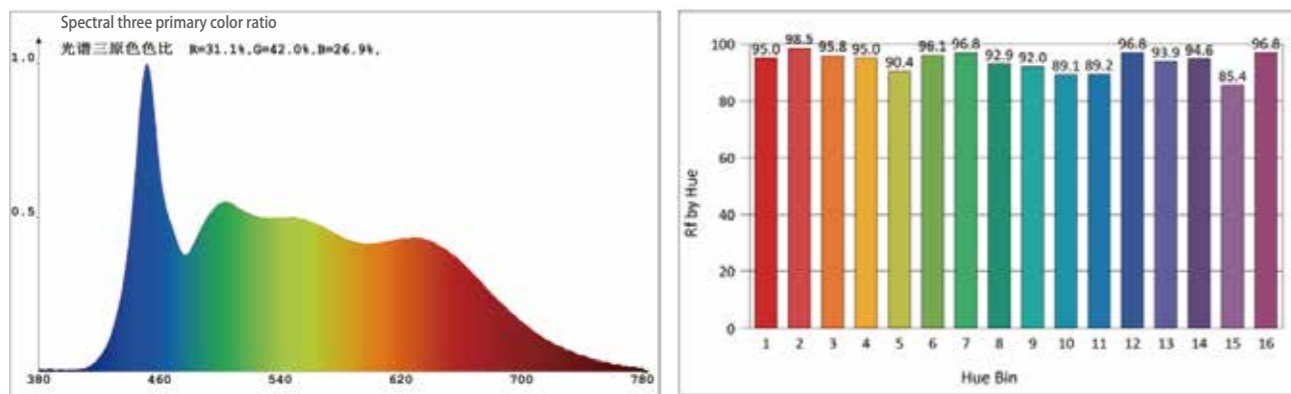

CRI>95, Color temperature: 6000K

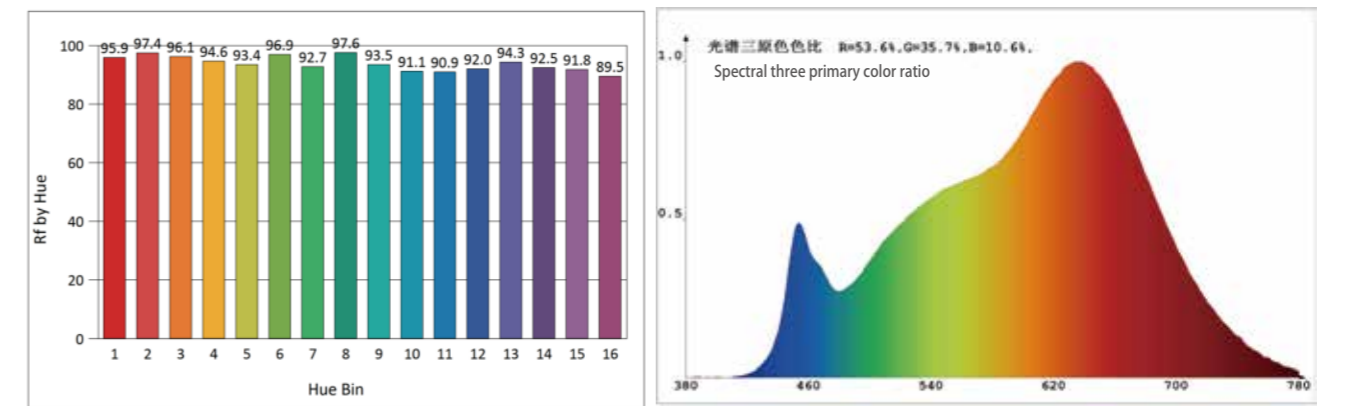

CRI>95, Color temperature: 3000K

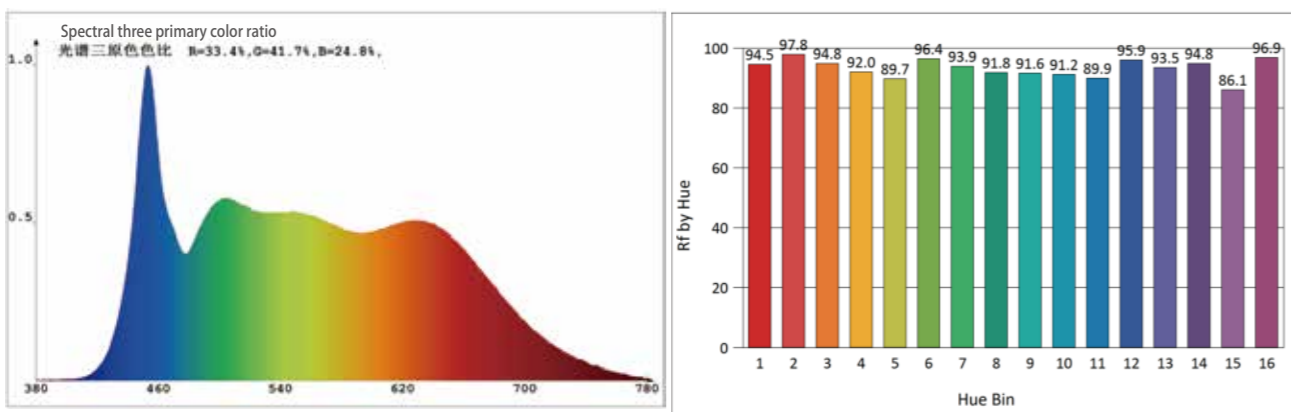

CRI>95, Color temperature: 5000K

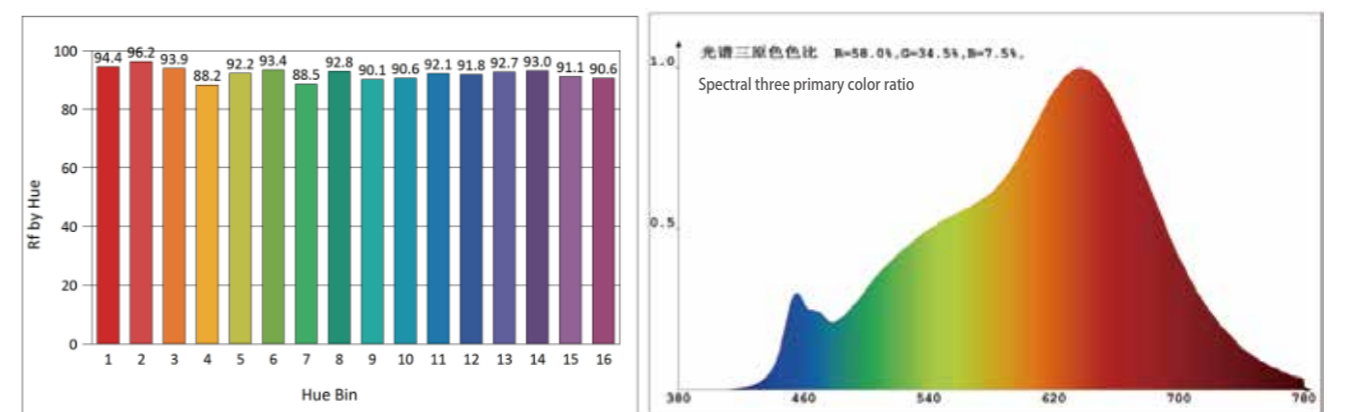

CRI>95, Color temperature: 2700K

COLORS Spectroscopic standard

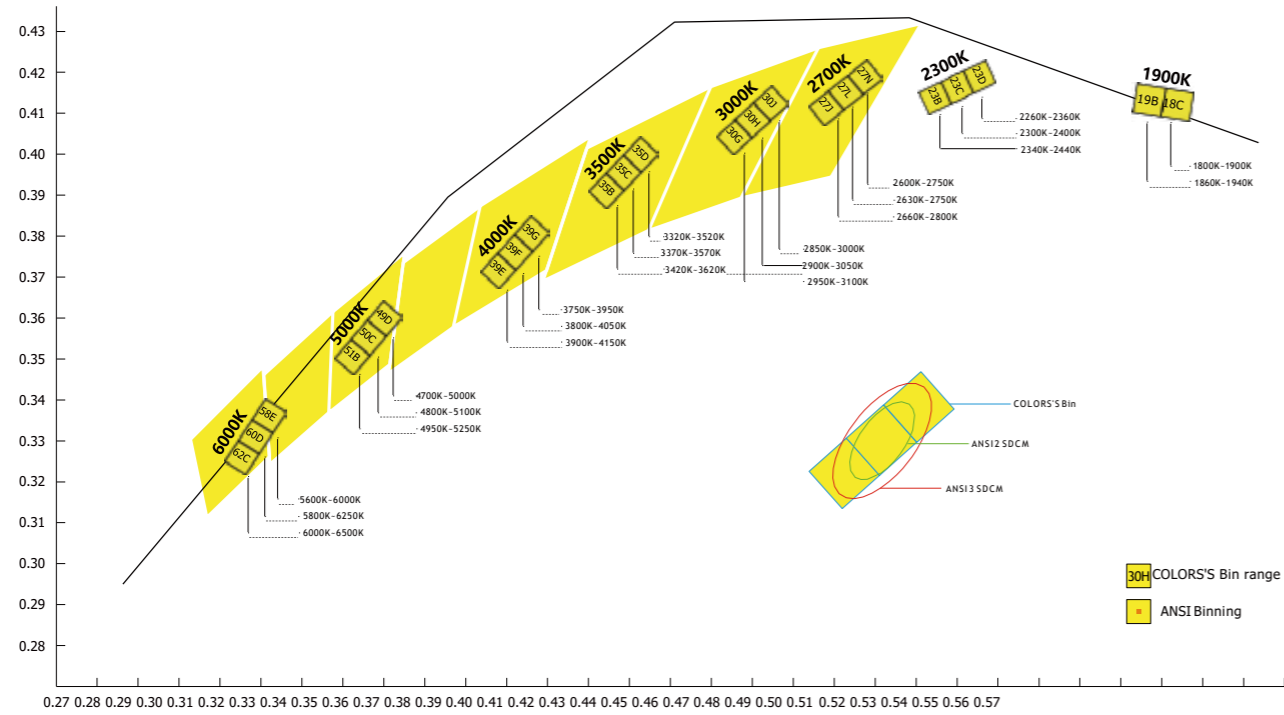

A thousand colors, your choice

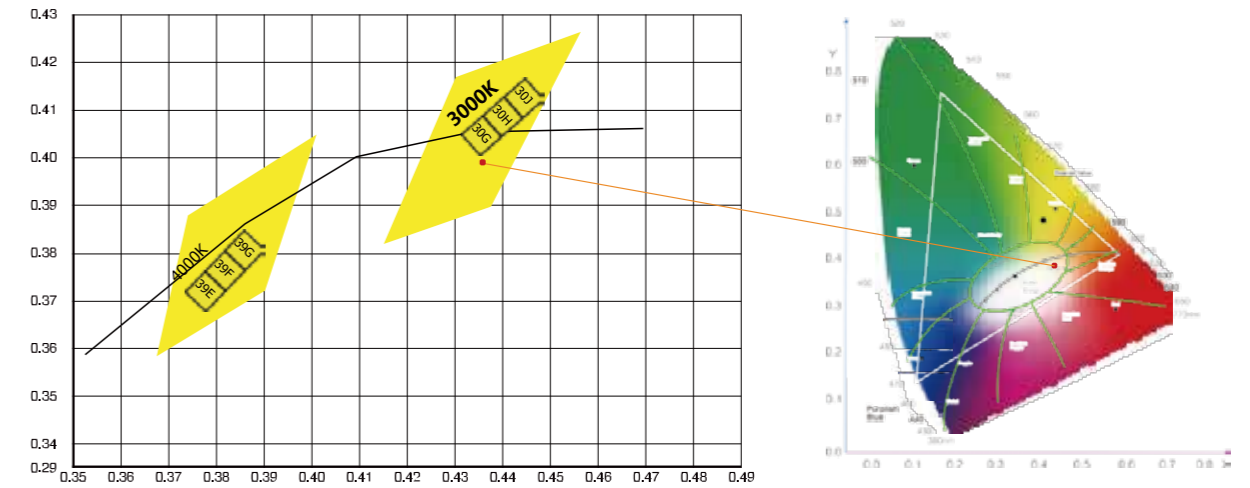

SDCM <2

Color tolerance < 2, There is no visual difference in the same batch of products



McAdam's ellipse of order 3

COLORS security

COLORS standard, The different batches have the same color, There is no visual difference in the same batch of products

<p>1 BIN ONLY</p> 	<p>2 Step SDCM</p> 	<p>VIP Same Forever</p> 
---	--	---

Color Application Guidelines

Different color temperatures are applied to different environments, and suitable color temperatures can be selected according to requirements

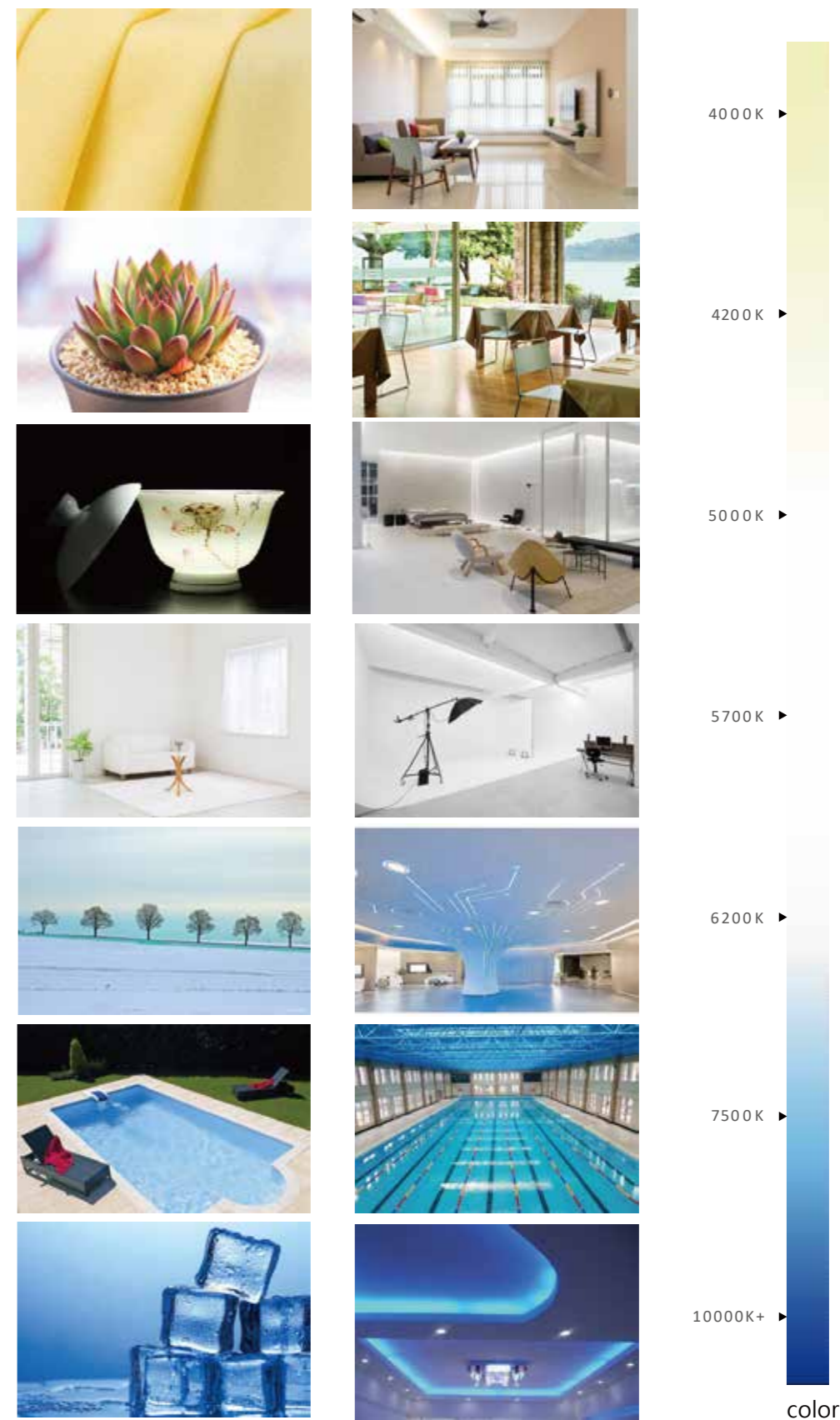
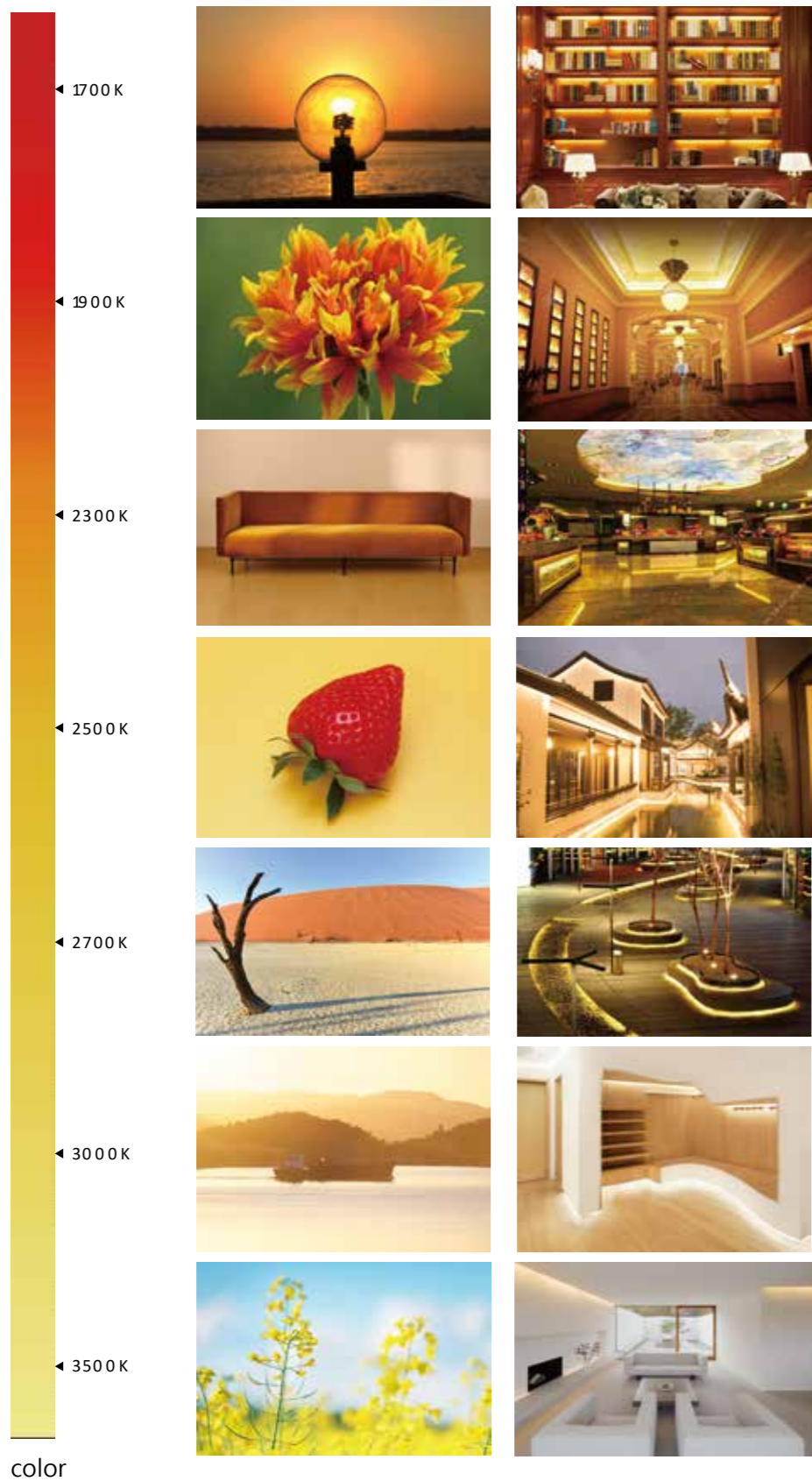

XXXXX

High Display/Universal lamp belt solution



Lamp with

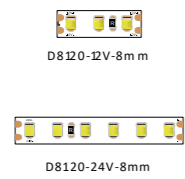

Multiple series and multiple models are optional
Special type, customized according to demand

Lamp bead

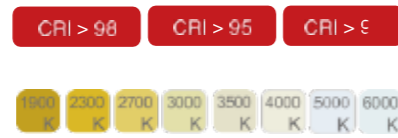

A variety of choices, free collocation
Custom color temperature, Custom BIN area

Protection technology



installation

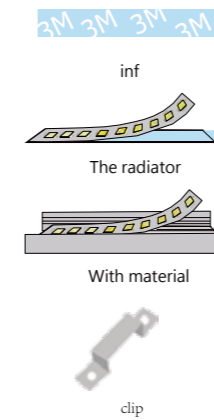

packaging

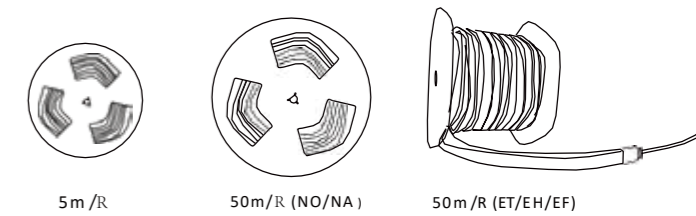

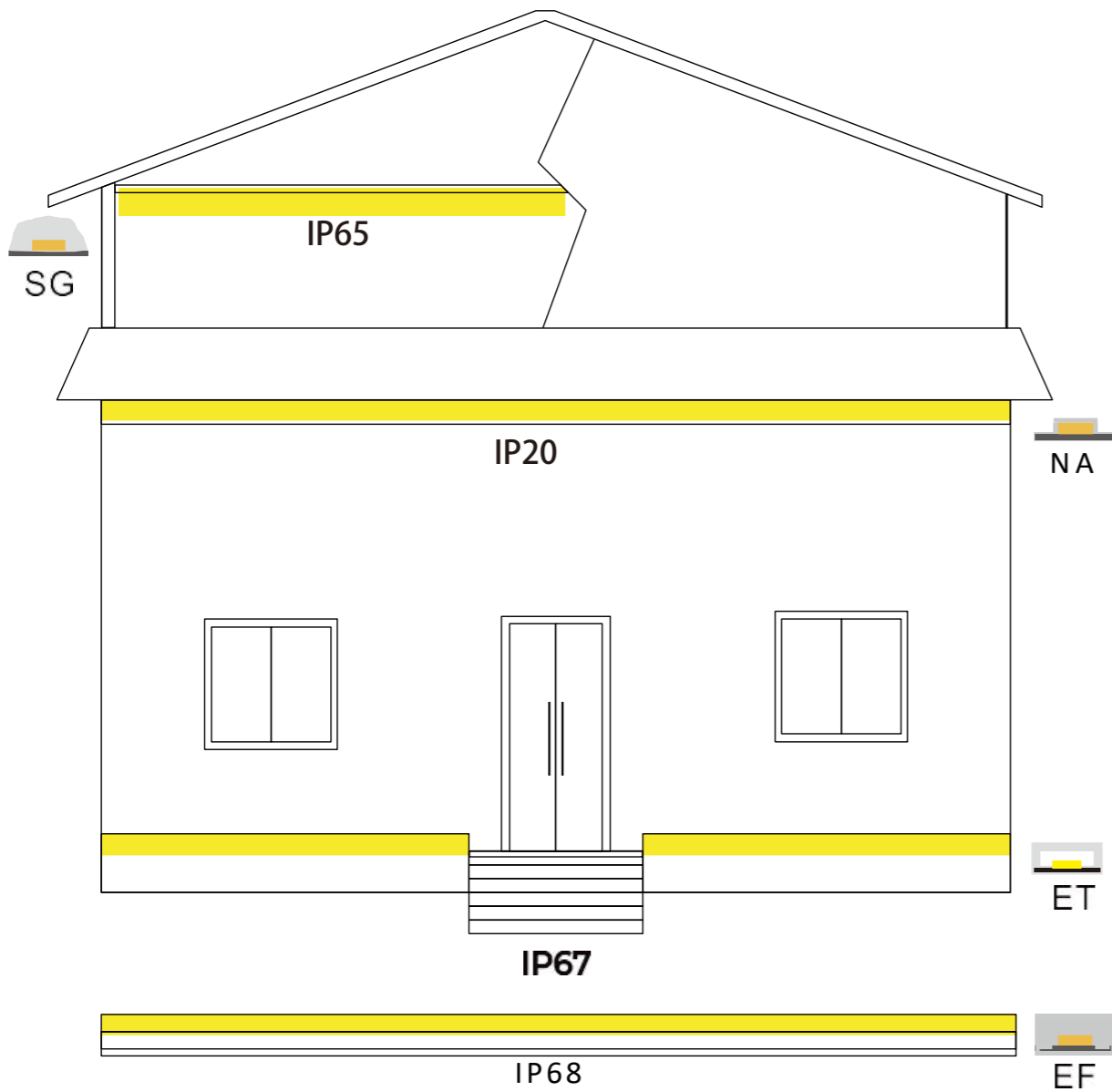

PROTECTION TECHNOLOGY

IP Rating	Waterproof technology	Graphic	Application
NANO/IP20	SPRAY ADHESIVE PROCESS		Usually used in dry conditions
SG/IP65	GLUE PROCESS		Can be used in humid environment
ET/IP67	CASING PROCESS		Can be used in a short immersion environment
EF/IP68	GLUE PROCESSX		Can be used in a short immersion environment

Lamp belt installation scheme

Conventional bare board light strip installation

1.The cutting

According to the cutting specification, cut from the solder joint, do not cut from other positions to avoid damage to this section of the lamp strip

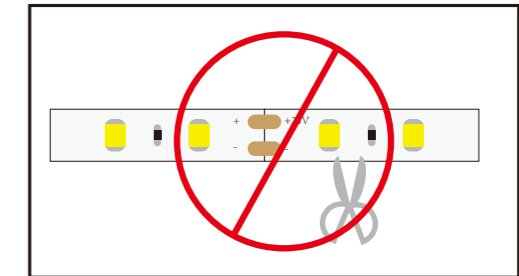
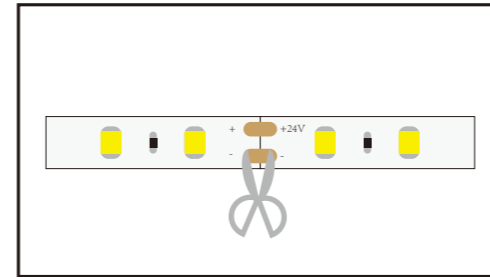

2. Tear the 3M double-sided adhesive paper after the lamp belt

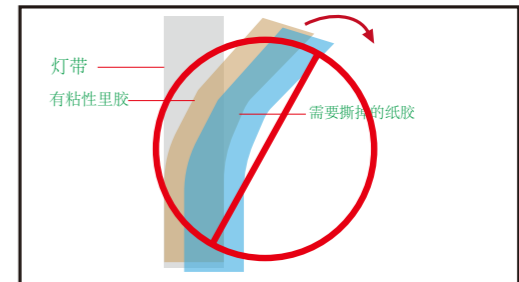
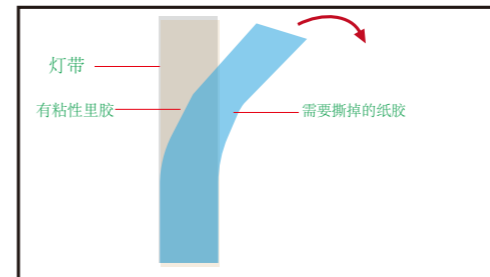

3. Paste

Clean the surface that needs to be pasted (to prevent pasting or falling off), compact the lamp belt on the surface and stick it firmly.

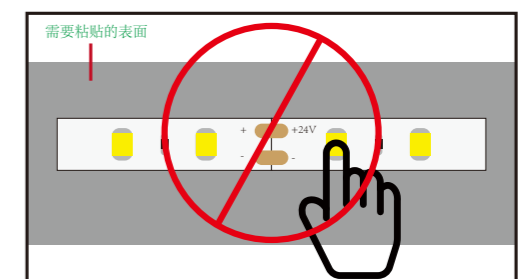
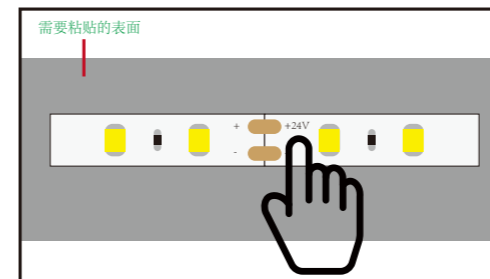

Casing of light strip installation

1.The cutting

Cut according to the cut specification, cut from the solder joint, and cut the outer sleeve together with the lamp belt.

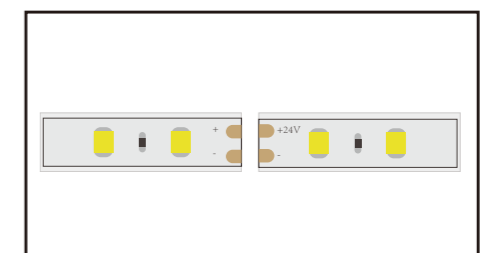
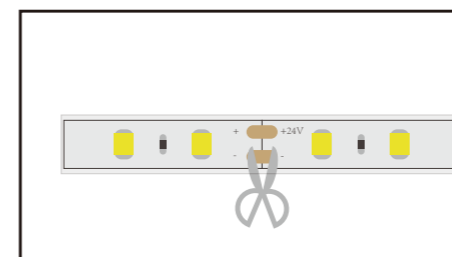

3. Welding line

Thread the power cable of a size less than or equal to the outlet plug in the direction of the arrow. Weld the power cable to the PCB with the red positive terminal and black negative terminal.

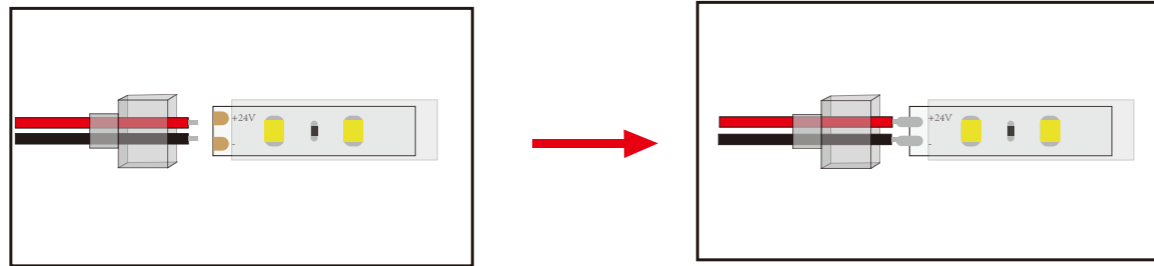

4. Install the plug

- ① Apply glue around the light strip plug, and insert the light strip into the plug. Wipe the excess glue from the plug and cable outlet
- ② Glue the tail plug (non-outlet plug) on the other end of the light strip in the same way

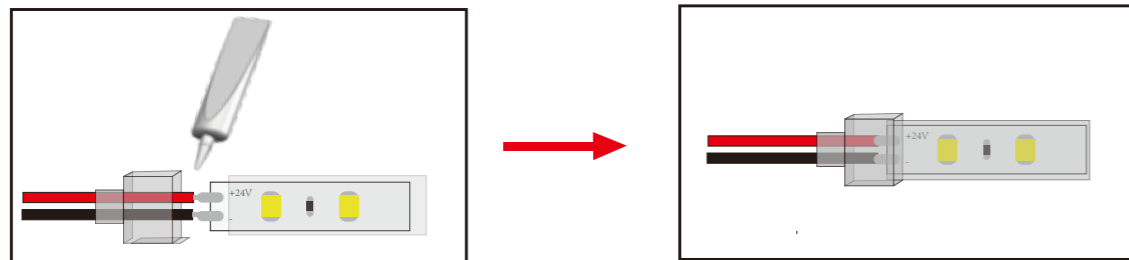

5. After the plug is installed, the table needs to be placed for 15-20 minutes to dry before it can be moved, and it will be completely cured for about 24h.

6. The lamp belt can be installed only after the plug glue is cured.

7. Paste

Clean the surface that needs to be pasted (to prevent pasting or falling off), compact the lamp belt on the surface and stick it firmly.

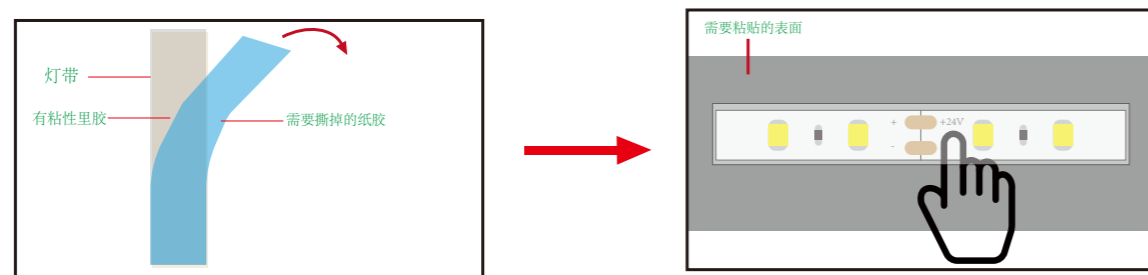

8. Clip installation

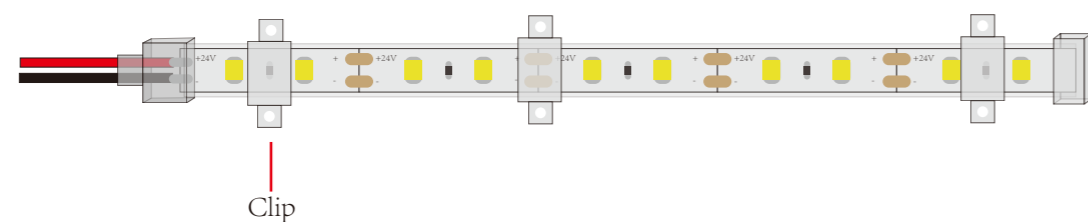

9. Place the lamp belt where it needs to be installed, fasten the clip, and tighten it with screws

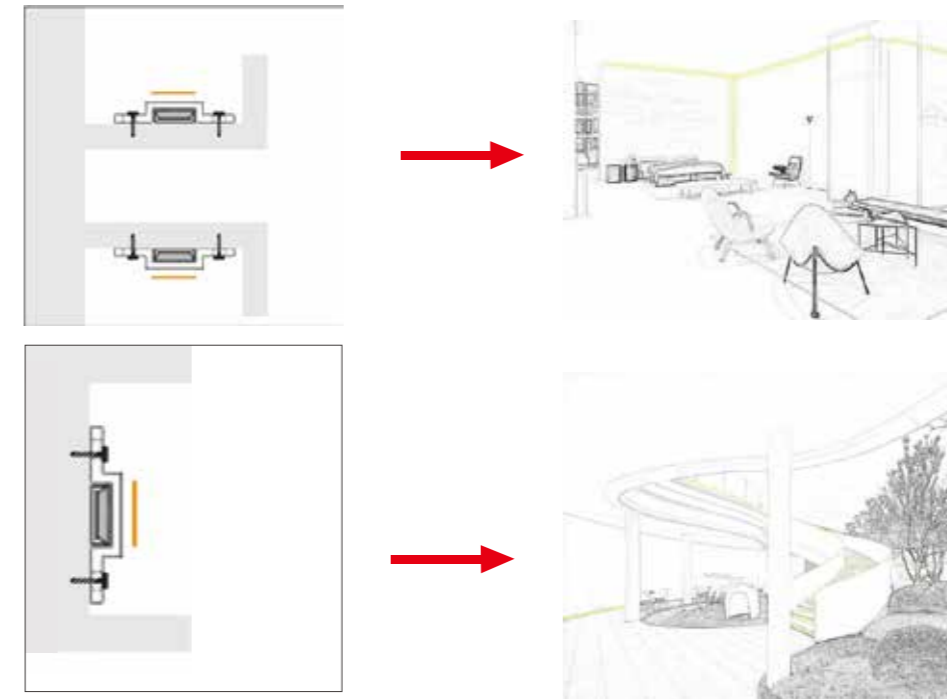

Connection to the Supply

1. Parallel connection mode

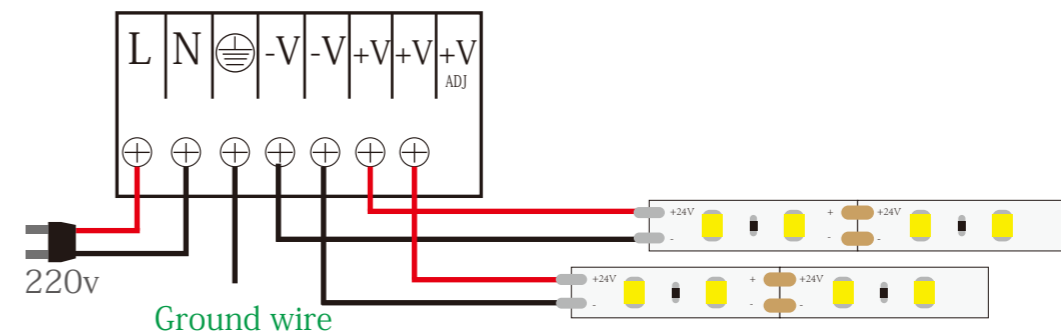

Connection mode of series circuit

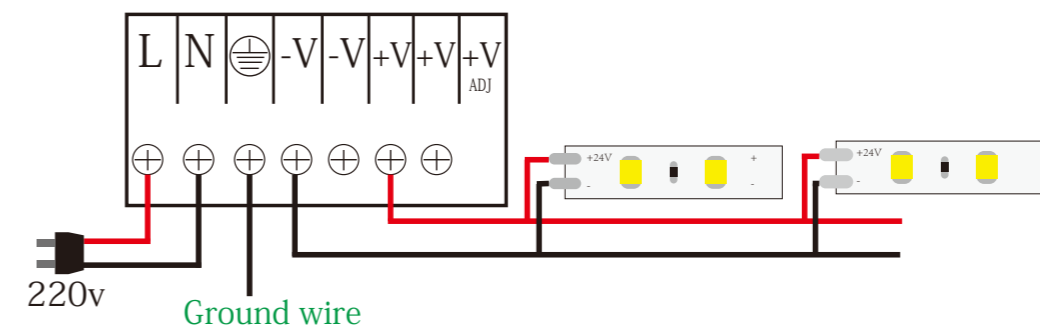

CRI LIGHT STRIP CLASSIFICATION



MONOCHROME SERIES

- 1.high color display, better show the authenticity of the object.
- 2.flexible tailoring, improve the utilization rate.
- 3.flexible bending, can be arbitrarily fixed in convex and concave surface, compact size.
- 4.composed of printed circuit boards, the back by double-sided tape, used for pasting,Small volume.
- 5.LED lamp beads high brightness low light decay.



Two-color temperature series

- 1.light belt warm white to positive white free choice;
- 2.double color temperature lamp beads, with three color temperature, a lamp belt,three kinds of experiences;
- 3.the lamp bead is dense, the luminous effect is beautiful, the lighting effect is good;
- 4.composed of printed circuit boards, the back by double-sided tape, used for pasting,small volume.

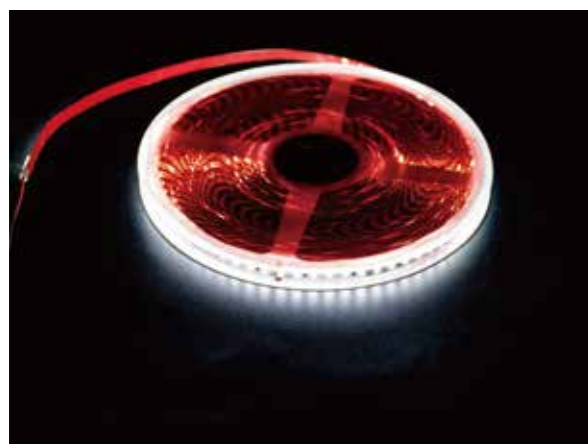

No pressure drop series

- 1.dimming, a variety of waterproof types can be selected, easy to operate, can be cut,can be connected;
 - 2.super long no pressure drop, stability, a single length of 15 meters;
 - 3.can be used in a variety of different occasions to meet different needs;
- Such as: home environment, large shopping malls, bars, roads, Bridges,

COLOR TEMPERATURE





THE LIST OF HIGH CRI /UNIVERSAL LIGHT STRIPS

Lamp bead types	Product number	Voltage (V)	power (w/m)	CRI	COLOR	LED QTY	Cut size	PCB Plate width (mm)	Packaging (m/R)	IP Rating	graphic
2835	12V2835-60D	12	12	>95/>80	2700k 3000k 4000k 5000k 6500k	60	3led/50mm	5/8	5	IP20 IP65 IP67 IP68	
	12V2835-120D	12	15	>95/>80	2700k 3000k 4000k 5000k 6500k	120	3led/25 mm	5/8	5	IP20 IP65 IP67 IP68	
	24V2835-60D	24	12	>95/>80	2700k 3000k 4000k 5000k 6500k	60	6led/100mm	5/8	5	IP20 IP65 IP67 IP68	
	24V2835-120D	24	15	>95/>80	2700k 3000k 4000k 5000k 6500k	120	6led/50mm	5/8	5	IP20 IP65 IP67 IP68	
2835 (Two lights a group)	24V2835-60D	24	12	>95/>80	2700k 3000k 4000k 5000k 6500k	60	2led/33.3mm	8	5	IP20 IP65 IP67 IP68	
	24V2835-120D	24	15	>95/>80	2700k 3000k 4000k 5000k 6500k	120	2led/16.6mm	8	5	IP20 IP65 IP67 IP68	
2835 (One lights a group)	5V2835-120D	5	15	>95/>80	2700k 3000k 4000k 5000k 6500k	120	1led/8.33mm	5/8	5	IP20 IP65 IP67 IP68	
	12V2835-120D	12	15	>95/>80	2700k 3000k 4000k 5000k 6500k	120	1led/8.33mm	5/8	5	IP20 IP65 IP67 IP68	
2835 (Two-color temperature)	24V2835-168D	24	9+9	>95/>80	2700k 4500k 6500k	168	12led/ 71.4mm	5	5	IP20 IP65 IP67 IP68	
	24V2835-216D	24	8+8	>95/>80	2700k 4500k 6500k	216	12led/55.5mm	10	5	IP20 IP65 IP67 IP68	
2216	24V2216-120D	24	8	>95/>80	2700k 3000k 4000k 5000k 6500k	120	6led/50mm	8	5	IP20 IP65 IP67 IP68	
5050	12V5050-30D	12	7	>95/>80	2700k 3000k 4000k 5000k 6500k	30	3led/50mm	10	5	IP20 IP65 IP67 IP68	
	12V5050-60D	12	12	>95/>80	2700k 3000k 4000k 5000k 6500k	60	3led/25mm	10	5	IP20 IP65 IP67 IP68	
	24V5050-30D	24	7	>95/>80	2700k 3000k 4000k 5000k 6500k	30	6led/100mm	10	5	IP20 IP65 IP67 IP68	
	24V5050-60D	24	12	>95/>80	2700k 3000k 4000k 5000k 6500k	60	6led/50mm	10	5	IP20 IP65 IP67 IP68	
No pressure drop series											
2835	24V2835-120D	24V	16	>95	2700k 3000k 4000k 5000k 6500k	120	6led/50mm	10	15	IP20 IP65 IP67 IP68	
	24V2835-120D	24V	16	>95	2700k 3000k 4000k 5000k 6500k	120	6led/50mm	8	15	IP20 IP65 IP67 IP68	
	48V2835-100D	48V	18	>95	2700k 3000k 4000k 5000k 6500k	100	5led/50mm	10	15	IP20 IP65 IP67 IP68	



MONOCHROME SERIES



12V2835-60D



(Two lights a group) 24V2835-60D



24V2216-120D



12V2835-120D



(Two lights a group) 24V2835-120D



12V5050-60D



24V2835-60D



(One lights a group) 5V2835-120D



24V5050-60D



24V2835-120D



(One lights a group) 12V2835-120D

12V2835-60LED

60 LED/M 8MM 12V 5M REEL 80 Lm/w

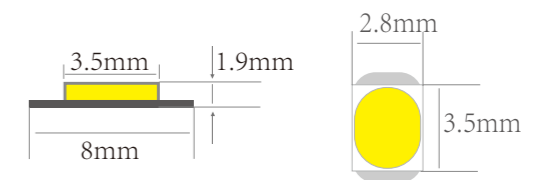
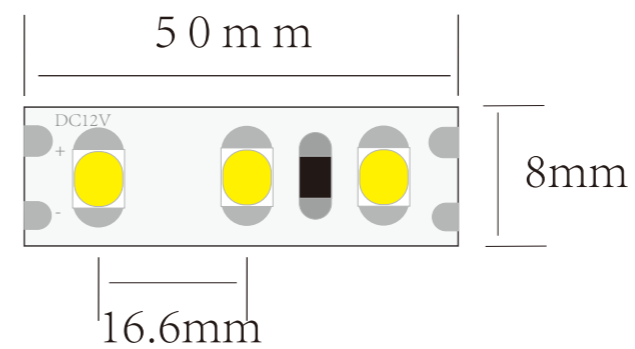

Product parameters

Product number: 12V2835-60LED

Lamp bead types: 2835

LED QTY: 60D/M

IP Rating: IP20/IP65/IP67/IP68

Cut size : 50mm

Color: 2700k-6500k (Customizable color)

PCB Plate width: 8mm

PCB COLOR: white

Packaging: 5M/R (Customizable length)

Photoelectric parameters

CRI: CRI>95/CRI>80

Luminous flux: 960~1080lm

Light efficiency : 80~90lm/w

Voltage: 12V

POWER: 12W/M

Product features

- 1.high color display, better show the authenticity of the object.
- 2.flexible tailoring, improve the utilization rate.
- 3.flexible bending, can be arbitrarily fixed in convex and concave surface, compact size.
- 4.composed of printed circuit boards, the back by double-sided tape, used for pasting,small volume.
- 5.LED lamp beads high show finger, high brightness, low light decay.

12V2835-120LED

60 LED/M 8MM 12V 5M REEL 80 Lm/w

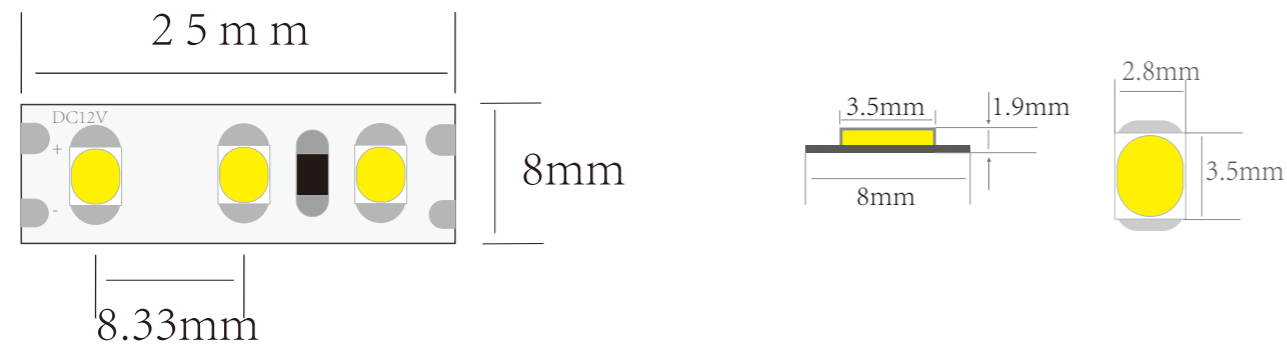

Product parameters

Product number: 12V2835-120LED
 LAMP BEAD TYPES: 2835
 LED QTY: 120D/M
 IP RATING: IP20/IP65/IP67/IP68
 CUT SIZE : 25mm
 COLOR: 2700k-6500k (Customizable color)
 PCB PLATE WIDTH: 8mm
 PCB COLOR: white
 PACKAGING: 5M/R (Customizable length)

Photoelectric parameters

CRI: CRI>95/CRI>80
 LUMINOUS FLUX: 1200~1350lm
 LIGHT EFFICIENCY : 80~90lm/w
 VOLTAGE: 12V
 POWER: 15W/M

Product features

- 1.high color display, better show the authenticity of the object.
- 2.flexible tailoring, improve the utilization rate.
- 3.flexible bending, can be arbitrarily fixed in convex and concave surface, compact size.
- 4.composed of printed circuit boards, the back by double-sided tape, used for pasting,small volume.
- 5.LED lamp beads high show finger, high brightness, low light decay.

24V2835-60LED

60 LED/M 8MM 24V 5M REEL 80 Lm/w

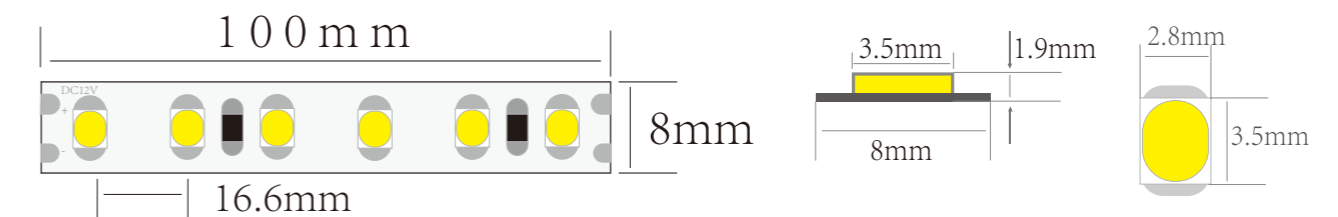

Product parameters

Product number: 24V2835-60LED
 LAMP BEAD TYPES: 2835
 LED QTY: 60D/M
 IP RATING: IP20/IP65/IP67/IP68
 CUT SIZE : 100mm
 COLOR: 2700k-6500k (Customizable color)
 PCB PLATE WIDTH: 8mm
 PCB COLOR: white
 PACKAGING: 5M/R (Customizable length)

Photoelectric parameters

CRI: CRI>95/CRI>80
 LUMINOUS FLUX: 960~1080lm
 LIGHT EFFICIENCY : 80~90lm/w
 VOLTAGE: 24V
 POWER: 12W/M

Product features

- 1.high color display, better show the authenticity of the object.
- 2.flexible tailoring, improve the utilization rate.
- 3.flexible bending, can be arbitrarily fixed in convex and concave surface, compact size.
- 4.composed of printed circuit boards, the back by double-sided tape, used for pasting,small volume.
- 5.LED lamp beads high show finger, high brightness, low light decay.

24V2835-120LED

120 LED/M 8MM 24V 5M REEL 80 Lm/w

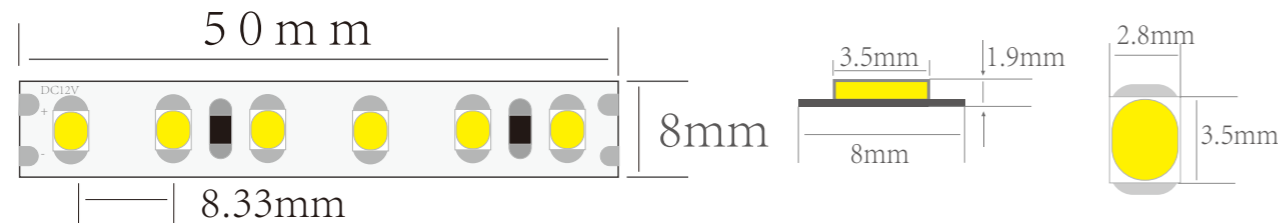

Product parameters

Product number: 24V2835-120LED
 LAMP BEAD TYPES: 2835
 LED QTY: 120D/M
 IP RATING: IP20/IP65/IP67/IP68
 CUT SIZE : 50mm
 COLOR: 2700k-6500k (Customizable color)
 PCB PLATE WIDTH: 8mm
 PCB COLOR: white
 PACKAGING: 5M/R (Customizable length)

Photoelectric parameters

CRI: CRI>95/CRI>80
 LUMINOUS FLUX: 1200~1350lm
 LIGHT EFFICIENCY : 80~90lm/w
 VOLTAGE: 24V
 POWER: 15W/M

Product features

- 1、色彩显色度高，更好展示物体的真实性。
- 2、剪裁灵活，提高利用率。
- 3、弯曲灵活，可任意固定在凹凸表面，体积小巧。
- 4、由印制电路板组成，背面由双面胶，用于粘贴，体积小。
- 5、LED灯珠高显指 高亮度低光衰。

(Two lights a group) 24V2835-60LED

60 LED/M 8MM 24V 5M REEL 80 Lm/w

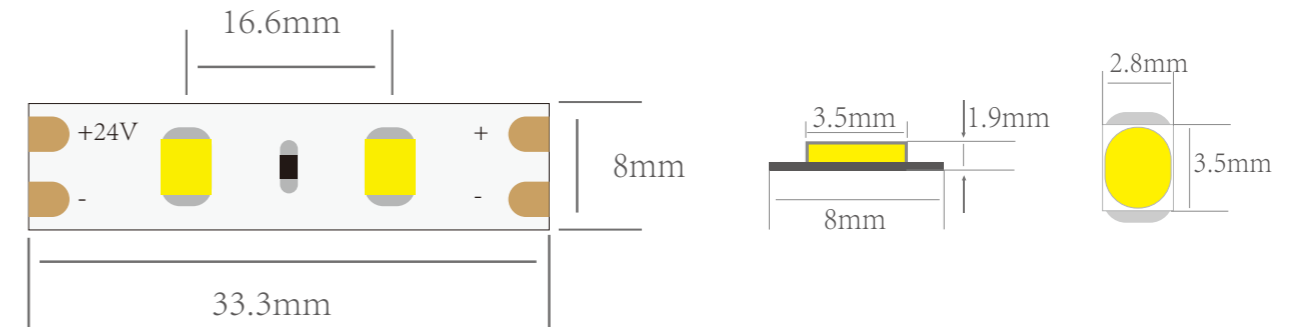

Product parameters

Product number: (Two lights a group) 24V2835-60LED
 LAMP BEAD TYPES: 2835
 LED QTY: 60D/M
 IP RATING: IP20/IP65/IP67/IP68
 CUT SIZE : 33.3mm
 COLOR: 2700k-6500k (Customizable color)
 PCB PLATE WIDTH: 8mm
 PCB COLOR: white
 PACKAGING: 5M/R (Customizable length)

Photoelectric parameters

CRI: CRI>95/CRI>80
 LUMINOUS FLUX: 960~1080lm
 LIGHT EFFICIENCY : 80~90lm/w
 VOLTAGE: 24V
 POWER: 12W/M

Product features

- 1.Two lights a group ultra-short cutting size, small space installation more fit, not waste.
- 2.flexible tailoring, improve the utilization rate.
- 3.can be freely bent, can be arbitrarily fixed on the convex and concave surface, compact size, rich color.
- 4.composed of printed circuit boards, the back by double-sided tape, used for pasting, small volume.
- 5.high of CRI.

(Two lights a group) 24V2835-120LED

120 LED/M 8MM 24V 5M REEL 80 Lm/w

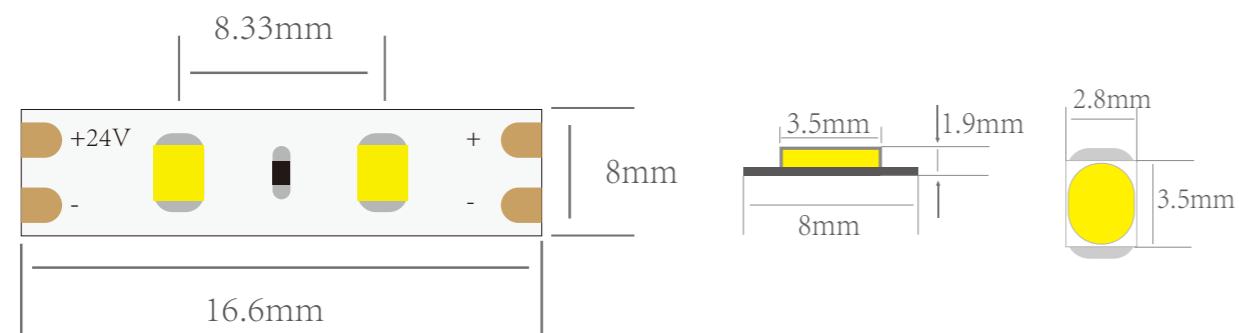

Product parameters

Product number: (Two lights a group) 24V2835-120LED
LAMP BEAD TYPES: 2835
LED QTY: 120D/M
IP RATING: IP20/IP65/IP67/IP68
CUT SIZE : 16.6mm
COLOR: 2700k-6500k (Customizable color)
PCB PLATE WIDTH: 8mm
PCB COLOR: white
PACKAGING: 5M/R (Customizable length)

Photoelectric parameters

CRI: CRI>95/CRI>80
LUMINOUS FLUX: 1200~1350lm
LIGHT EFFICIENCY : 80~90lm/w
VOLTAGE: 24V
POWER: 15W/M

Product features

1. Two lights a group ultra-short cutting size, small space installation more fit, not waste.
2. flexible tailoring, improve the utilization rate.
3. can be freely bent, can be arbitrarily fixed on the convex and concave surface, compact size, rich color.
4. composed of printed circuit boards, the back by double-sided tape, used for pasting, small volume.
5. high of CRI.

(One lights a group) 5V2835-120LED

120 LED/M 8MM 5V 5M REEL 80 Lm/w

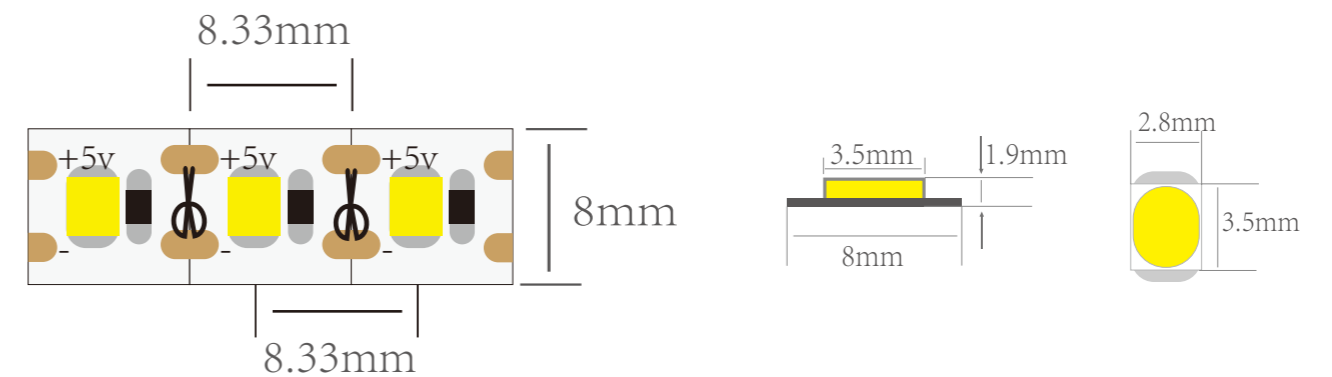

Product parameters

Product number: (One lights a group) 5V2835-120LED
LAMP BEAD TYPES: 2835
LED QTY: 120D/M
IP RATING: IP20/IP65/IP67/IP68
CUT SIZE : 8.33mm
COLOR: 2700k-6500k (Customizable color)
PCB PLATE WIDTH: 8mm
PCB COLOR: white
PACKAGING: 5M/R (Customizable length)

Photoelectric parameters

CRI: CRI>95/CRI>80
LUMINOUS FLUX: 1200~1350lm
LIGHT EFFICIENCY : 80~90lm/w
VOLTAGE: 5V
POWER: 15W/M

Product features

1. One lights a group ultra-short cutting size, small space installation more fit, not waste.
2. flexible tailoring, improve the utilization rate.
3. can be freely bent, can be arbitrarily fixed on the convex and concave surface, compact size, rich color.
4. composed of printed circuit boards, the back by double-sided tape, used for pasting, small volume.
5. 5V low voltage power supply, safe and reliable, maintenance free.

(One lights a group) 12V2835-120LED

120 LED/M 8MM 12V 5M REEL 80 Lm/w

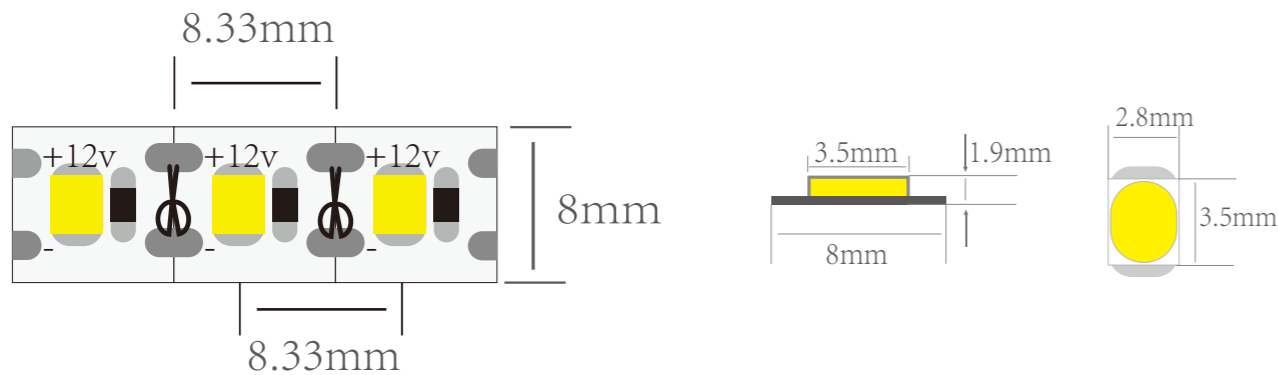

Product parameters

Product number: (One lights a group) 12V2835-120LED
 LAMP BEAD TYPES: 2835
 LED QTY: 120D/M
 IP RATING: IP20/IP65/IP67/IP68
 CUT SIZE : 8.33mm
 COLOR: 2700k-6500k (Customizable color)
 PCB PLATE WIDTH: 8mm
 PCB COLOR: white
 PACKAGING: 5M/R (Customizable length)

Photoelectric parameters

CRI: CRI>95/CRI>80
 LUMINOUS FLUX: 1200~1350lm
 LIGHT EFFICIENCY : 80~90lm/w
 VOLTAGE: 12V
 POWER: 15W/M

Product features

1. One lights a group ultra-short cutting size, small space installation more fit, not waste.
2. flexible tailoring, improve the utilization rate.
3. can be freely bent, can be arbitrarily fixed on the convex and concave surface, compact size, rich color.
4. composed of printed circuit boards, the back by double-sided tape, used for pasting, small volume.

24V2216-120LED

120 LED/M 8MM 24V 5M REEL 80 Lm/w

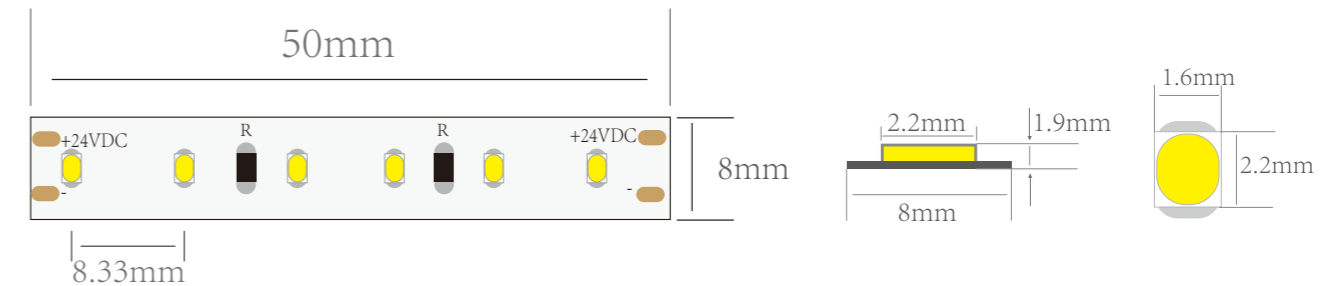

Product parameters

Product number: 24V2216-120LED
 LAMP BEAD TYPES: 2216
 LED QTY: 120D/M
 IP RATING: IP20/IP65/IP67/IP68
 CUT SIZE : 50mm
 COLOR: 2700k-6500k (Customizable color)
 PCB PLATE WIDTH: 8mm
 PCB COLOR: white
 PACKAGING: 5M/R (Customizable length)

Photoelectric parameters

CRI: CRI>95/CRI>80
 LUMINOUS FLUX: 640~720lm
 LIGHT EFFICIENCY : 80~90lm/w
 VOLTAGE: 24V
 POWER: 8W/M

Product features

1. Small size, low cost, simple production process and low cost;
2. Hard lamp design flexible, flexible bending, suitable for a variety of irregular places;
3. High color index, uniform light color;
4. High density lamp belt, suitable for small size profiles or structures, etc.

12V5050-60LED

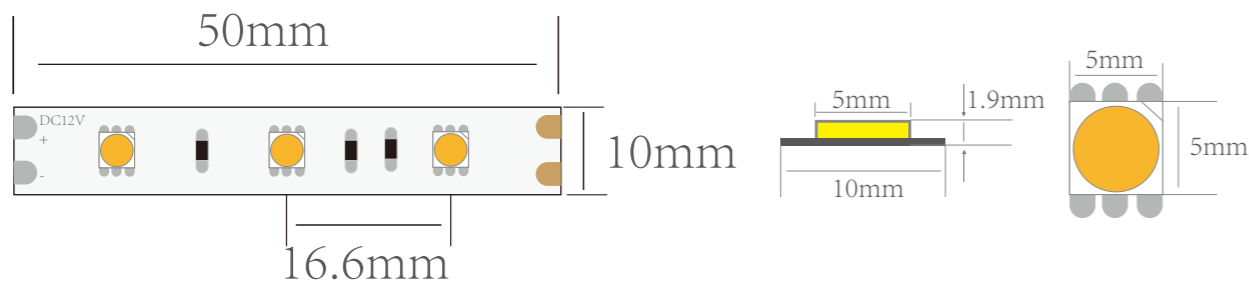

Product parameters

Product number: 12V5050-60LED
 LAMP BEAD TYPES: 5050
 LED QTY: 60D/M
 IP RATING: IP20/IP65/IP67/IP68
 CUT SIZE : 50mm
 COLOR: 2700k-6500k (Customizable color)
 PCB PLATE WIDTH: 10mm
 PCB COLOR: white
 PACKAGING: 5M/R (Customizable length)

Photoelectric parameters

CRI: CRI>95/CRI>80
 LUMINOUS FLUX: 960~1080lm
 LIGHT EFFICIENCY : 80~90lm/w
 VOLTAGE: 12V
 POWER: 12W/M

Product features

- 1.high color display, better show the authenticity of the object.
- 2.flexible tailoring, improve the utilization rate.
- 3.composed of printed circuit boards, the back by double-sided adhesive, used for pasting,small volume.
- 4.LED lamp beads high brightness low light decay.

24V5050-60LED

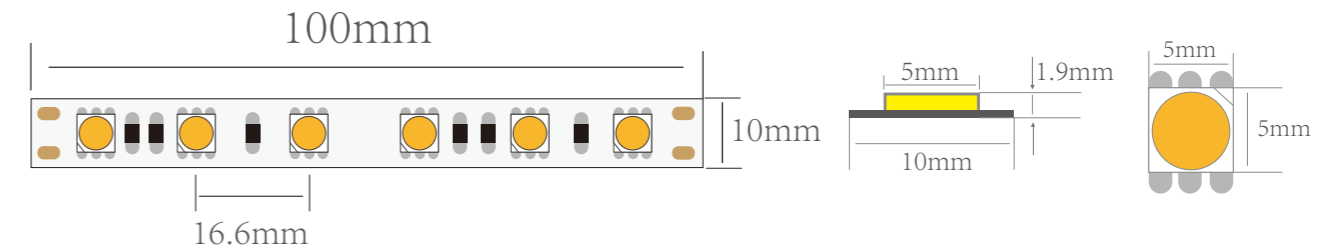

Product parameters

Product number: 24V5050-60LED
 LAMP BEAD TYPES: 5050
 LED QTY: 60D/M
 IP RATING: IP20/IP65/IP67/IP68
 CUT SIZE : 100mm
 COLOR: 2700k-6500k (Customizable color)
 PCB PLATE WIDTH: 10mm
 PCB COLOR: white
 PACKAGING: 5M/R (Customizable length)

Photoelectric parameters

CRI: CRI>95/CRI>80
 LUMINOUS FLUX: 960~1080lm
 LIGHT EFFICIENCY : 80~90lm/w
 VOLTAGE: 24V
 POWER: 12W/M

Product features

- 1.high color display, better show the authenticity of the object.
- 2.flexible tailoring, improve the utilization rate.
- 3.composed of printed circuit boards, the back by double-sided adhesive, used for pasting,small volume.
- 4.LED lamp beads high brightness low light decay.



(Two-color temperature)24V2835-168LED

168 LED/M 5MM 24V 5M REEL 80 Lm/w

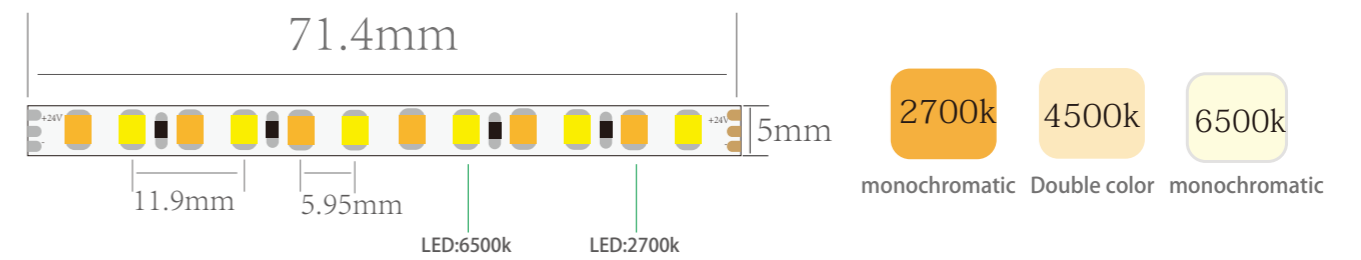

Two-color temperature series



(Two-color temperature)24V2835-168led



(Two-color temperature)24V2835-120led



(Two-color temperature)24V2835-216led

Product parameters

Product number: (Two-color temperature)24V2835-168led
 LAMP BEAD TYPES: 2835
 LED QTY: 84+48D/M
 IP RATING: IP20/IP65/IP67/IP68
 CUT SIZE : 71.4mm
 COLOR: 2700k、6500k
 PCB PLATE WIDTH: 5mm
 PCB COLOR: white
 PACKAGING: 5M/R (Customizable length)

Photoelectric parameters

CRI: CRI>95/CRI>80
 LUMINOUS FLUX: 1440~1620lm
 LIGHT EFFICIENCY : 80~90lm/w
 VOLTAGE: 24V
 POWER: 9+9W/M

Product features

- 1.light belt warm white to positive white free choice;
- 2.plate width 5mm, compatible with all kinds of small space, installation, electronic products ,form a complete set;
- 3.the lamp bead is dense, the luminous effect is beautiful, the lighting effect is good;

(Two-color temperature) 24V2835-216LED

216 LED/M 10MM 24V 5M REEL 80 Lm/w

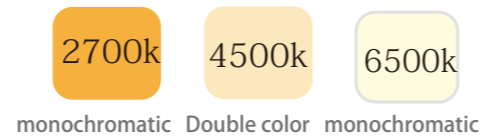
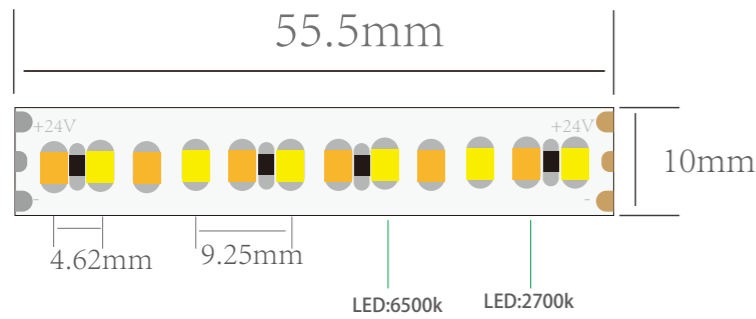

Product parameters

Product number: (Two-color temperature)24V2835-216led
 LAMP BEAD TYPES: 2835
 LED QTY: 108+108D/M
 IP RATING: IP20/IP65/IP67/IP68
 CUT SIZE : 55.5mm
 COLOR: 2700k、 6500k
 PCB PLATE WIDTH: 10mm
 PCB COLOR: white
 PACKAGING: 5M/R (Customizable length)

Photoelectric parameters

CRI: CRI>95/CRI>80
 LUMINOUS FLUX: 1280~1440lm
 LIGHT EFFICIENCY : 80~90lm/w
 VOLTAGE: 24V
 POWER: 8+8W/M

Product features

- 1.light belt warm white to positive white free choice;
- 2.plate width 5mm, compatible with all kinds of small space, installation, electronic products ,form a complete set;
- 3.the lamp bead is dense, the luminous effect is beautiful, the lighting effect is good;

(Two-color temperature) 24V2835-120LED

120 LED/M 8MM 24V 5M REEL 80 Lm/w

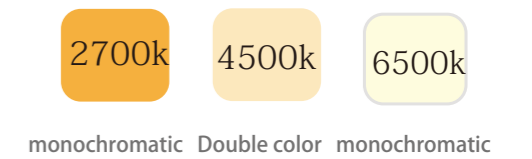
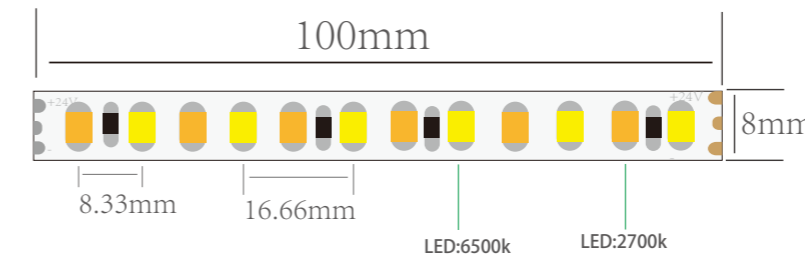

Product parameters

Product number: (Two-color temperature)24V2835-120led
 LAMP BEAD TYPES: 2835
 LED QTY: 60+60D/M
 IP RATING: IP20/IP65/IP67/IP68
 CUT SIZE : 100mm
 COLOR: 2700k、 6500k
 PCB PLATE WIDTH: 8mm
 PCB COLOR: white
 PACKAGING: 5M/R (Customizable length)

Photoelectric parameters

CRI: CRI>95/CRI>80
 LUMINOUS FLUX: 1280~1440lm
 LIGHT EFFICIENCY : 80~90lm/w
 VOLTAGE: 24V
 POWER: 8+8W/M

Product features

- 1.light belt warm white to positive white free choice;
- 2.plate width 5mm, compatible with all kinds of small space, installation, electronic products ,form a complete set;
- 3.the lamp bead is dense, the luminous effect is beautiful, the lighting effect is good;



(Constant current without pressure drop) 24V2835-120LED

120 LED/M 10MM 24V 15M REEL 80 Lm/w

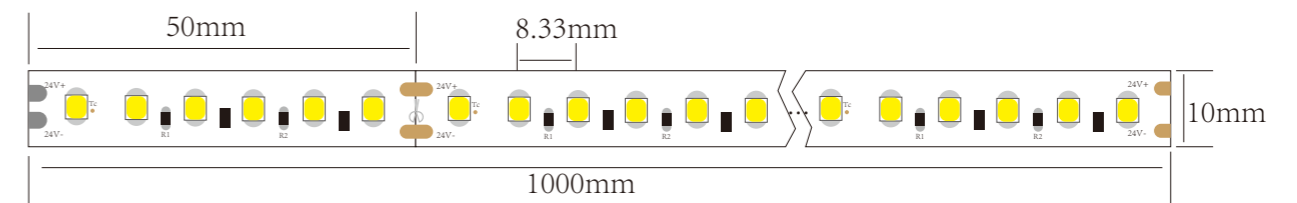

No pressure drop series

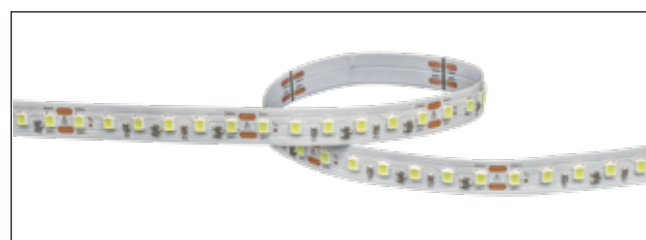

24V2835b65k-120led



48V2835-100led



242835-120led

Product parameters

Product number: 24V2835-120LED
 LAMP BEAD TYPES: 2835
 LED QTY: 120D/M
 IP RATING: IP20/IP65/IP67/IP68
 CUT SIZE : 50mm
 COLOR: 2700k-6500k (Customizable color)
 PCB PLATE WIDTH: 10mm
 PCB COLOR: white
 PACKAGING: 15M/R (Customizable length)

Photoelectric parameters

CRI: CRI>95/CRI>80
 LUMINOUS FLUX: 800~900lm
 LIGHT EFFICIENCY : 80~90lm/w
 VOLTAGE: 24V
 POWER: 10W/M

Product features

1. dimming, various waterproof types are optional, easy to operate, can cut, can be connected;
2. super long no pressure drop, stability, a single length of 15 meters;
3. can be used in a variety of different occasions to meet different needs; Such as: home environment, large shopping malls, bars, roads,

(No pressure drop) 24V2835-120LED

120 LED/M 8MM 24V 15M REEL 80 Lm/w

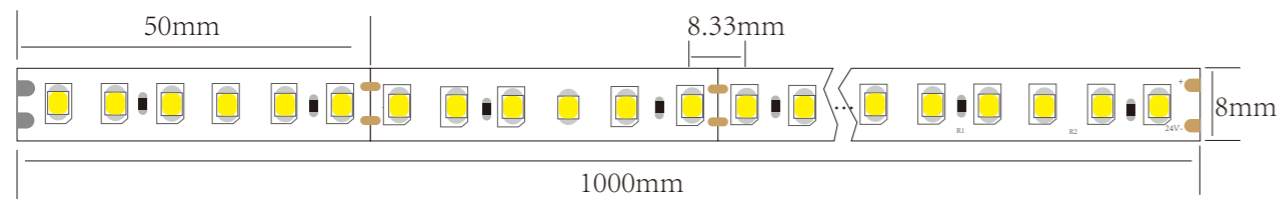

Product parameters

Product number: 24V2835-120LED
LAMP BEAD TYPES: 2835
LED QTY: 120D/M
IP RATING: IP20/IP65/IP67/IP68
CUT SIZE : 50mm
COLOR: 2700k-6500k (Customizable color)
PCB PLATE WIDTH: 8mm
PCB COLOR: white
PACKAGING: 15M/R (Customizable length)

Photoelectric parameters

CRI: CRI>95/CRI>80
LUMINOUS FLUX: 400~450lm
LIGHT EFFICIENCY : 80~90lm/w
VOLTAGE: 24V
POWER: 5W/M

Product features

1. dimming, various waterproof types are optional, easy to operate, can cut, can be connected;
2. super long no pressure drop, stability, a single length of 15 meters;
3. can be used in a variety of different occasions to meet different needs; Such as: home environment, large shopping malls, bars, roads,

(No pressure drop) 48V2835-100LED

100 LED/M 10MM 48V 15M REEL 80 Lm/w

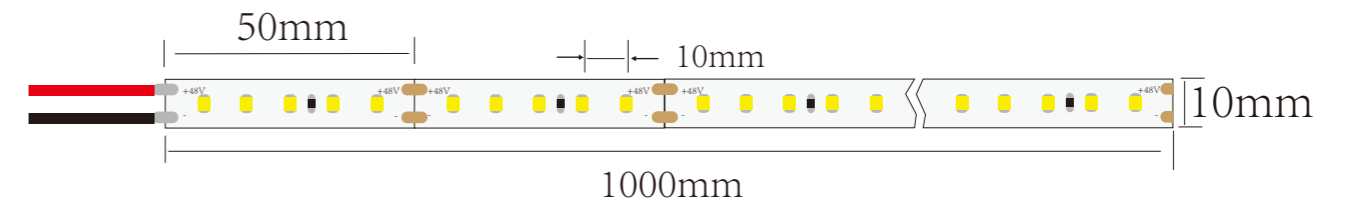

Product parameters

Product number: 48V2835-100LED
LAMP BEAD TYPES: 2835
LED QTY: 100D/M
IP RATING: IP20/IP65/IP67/IP68
CUT SIZE : 50mm
COLOR: 2700k-6500k (Customizable color)
PCB PLATE WIDTH: 10mm
PCB COLOR: white
PACKAGING: 15M/R (Customizable length)

Photoelectric parameters

CRI: CRI>95/CRI>80
LUMINOUS FLUX: 1440~1620lm
LIGHT EFFICIENCY : 80~90lm/w
VOLTAGE: 48V
POWER: 18W/M

Product features

- 1, super long connection without voltage drop, avoid more wiring, a single length of 15 meters;
- 2, color index >95, closer to the sunlight;
- 3, adhesive design, used for pasting, easy installation.



COB LIGHT STRIP SERIES

The luminous surface is a linear colloid due to the structural characteristics of the COB lamp strip. Because the COB chip is directly fixed on the PCB board, the heat of the chip can be quickly transferred to the PCB board, and then the COB lamp belt has a smaller light decline and a longer life. The luminous angle of the luminous surface of the COB lamp strip can reach 180°.

Comparison of conventional and COB light strips



VS

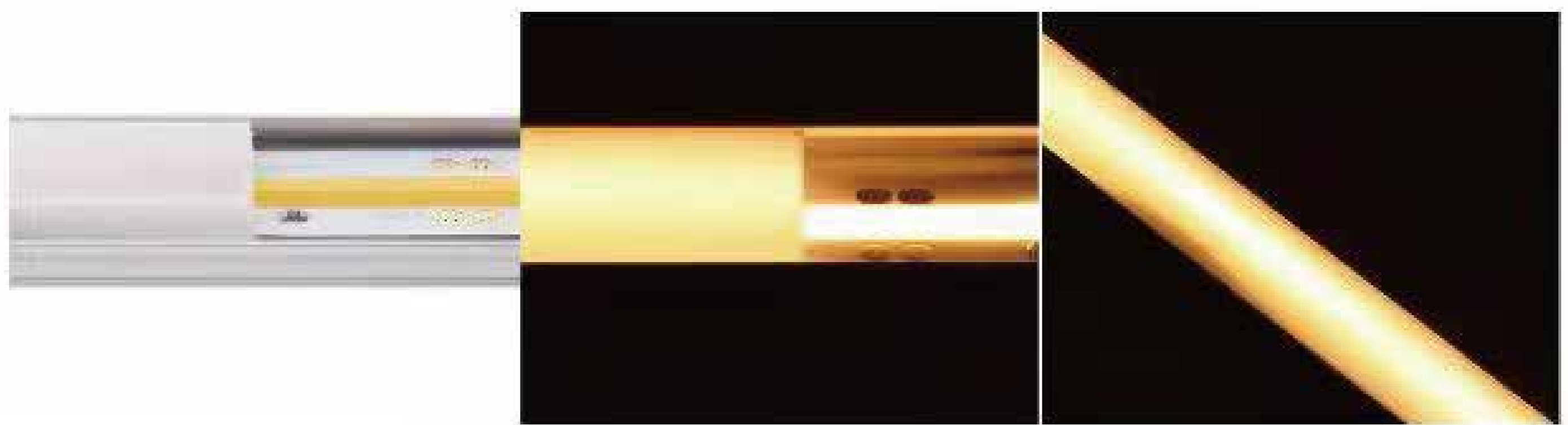



COB light strip glowing effect

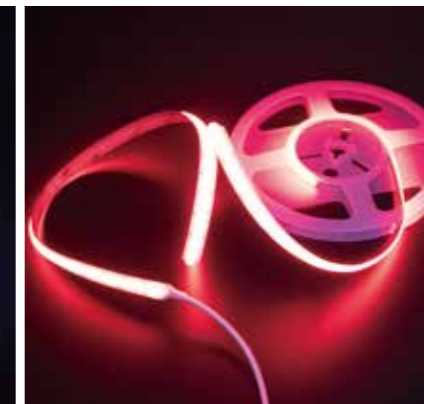
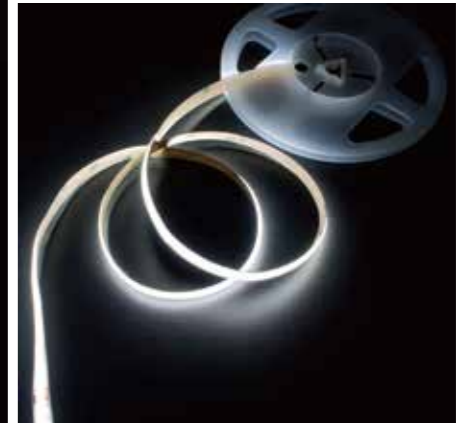

COB light strip solution

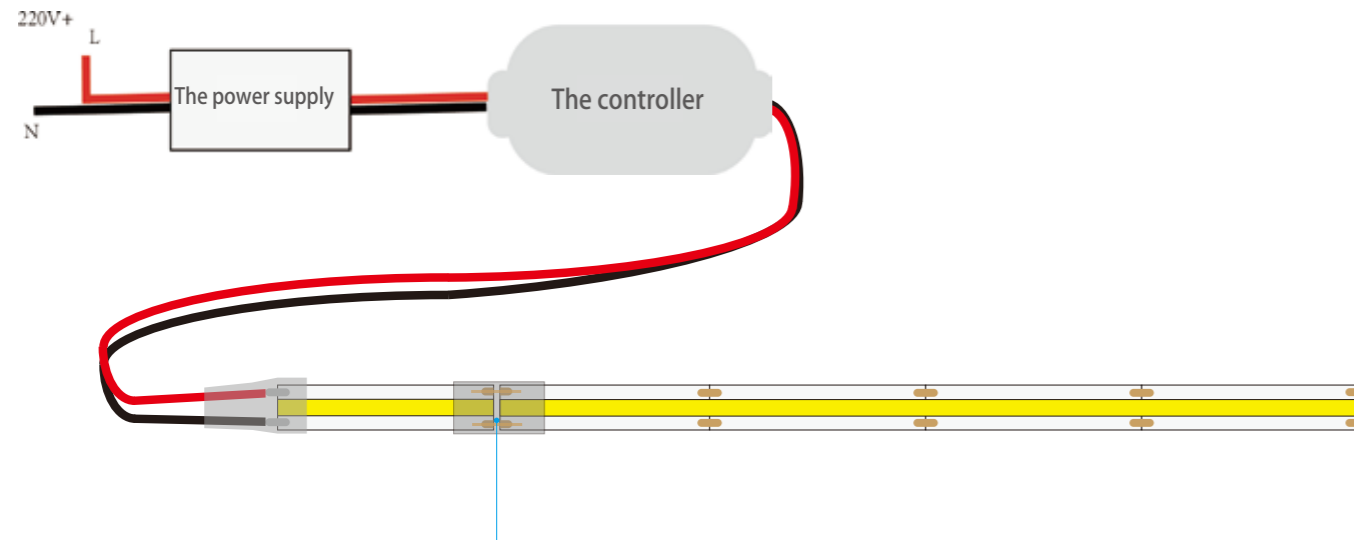

The connector

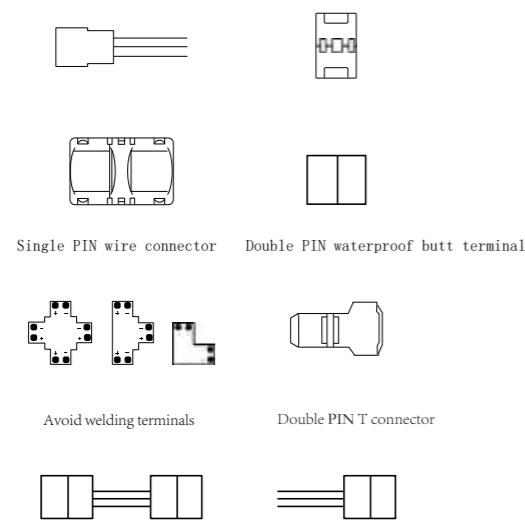

To qualify

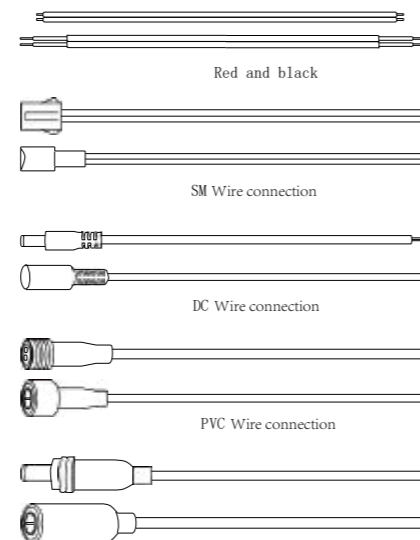

packaging

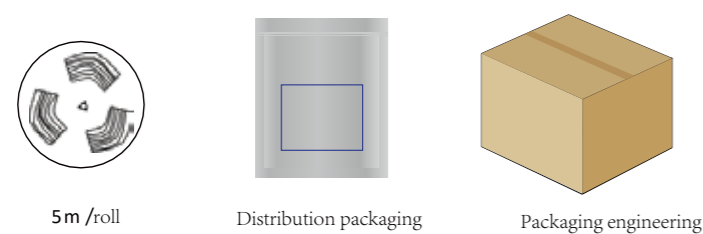

Recommended Connectors

Product name	applicable Board width	applicable lamp number	diagram
Monochrome intermediate connector	8mm/10mm	312/320/384/480/528	
Monochrome end cable connector	8mm/10mm	312/320/384/480/528	
Monochrome dual connector	8mm/10mm	312/320/384/480/528	
RGB/Dual color temperature intermediate connector	10mm	608/756/768	
RGB tail end connector	10mm	756/768	
Dual color temperature end cable connector	10mm	608	
Monochrome corner connector	8mm/10mm	312/320/384/480/528	
Monochrome T connector	8mm/10mm	312/320/384/480/528	

COB light strip installation

1. cutting

Cut according to the cut specification, cut from the solder joints

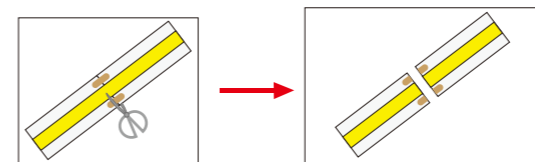

2. Install the connector

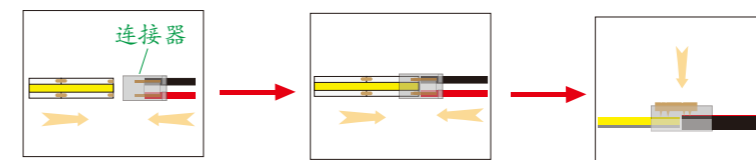

3. paste

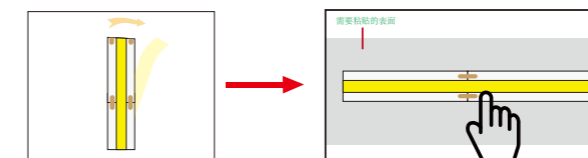

List of COB light strips

Serial number	voltage (V)	Power (w/m)	COLOR	LED QTY	CUT SIZE	PCB Plate width	packaging (m/R)	CRI	graphic
COB-312	12V	11	2700k 3000k 4000k 6000k	312	19.23mm	8mm	5	>90	
	24V	11	2700k 3000k 4000k 6000k	312	38.46mm	8mm	5	>90	
COB-320	5V	8	2700k 3000k 4000k 6000k	320	50mm	10mm	5	>90	
	12V	8	2700k 3000k 4000k 6000k	320	25mm	8mm	5	>90	
COB-320	24V	8	2700k 3000k 4000k 6000k	320	50mm	8mm	5	>90	
	12V/24V	10	2700k 3000k 4000k 6000k	384	41.66mm	8mm	5	>90	
COB-384	24V	10	2700k 3000k 4000k 6000k	384(No pressure drop)	41.66mm	8mm	5	>90	
	12V/24V	10	2700k 3000k 4000k 6000k	384	41.66mm	5mm	5	>90	
COB-480	12V	10	2700k 3000k 4000k 6000k	480	25mm	8mm	5	>90	
	24V	10	2700k 3000k 4000k 6000k	480	50mm	8mm	5	>90	
COB-528	12V	14	2700k 3000k 4000k 6000k	528	45.45mm	10mm	5	>90	
	24V	14	2700k 3000k 4000k 6000k	528	45.45mm	10mm	5	>90	
COB-600	12V	7+7	2700k 6500k	600	10mm	5mm	5	>90	
	24V	7+7	2700k 6500k	600	20mm	5mm	5	>90	
COB-608	12V	7+7	2700k 6500k	608	26.31mm	10mm	5	>90	
	24V	7+7	2700k 6500k	608	26.31mm	10mm	5	>90	
COB-640	24V	15	2700k 6500k	640	50mm	10mm	5	>90	
COB-576	24V	14	RGB	576	/	10mm	5	/	
COB-840	24V	15	RGB	840	25mm	10mm	5	/	

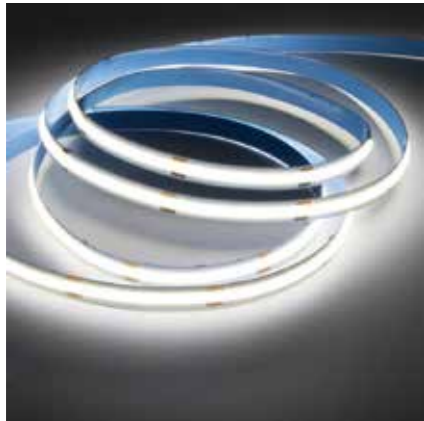

COB MONOCHROME SERIES

1. COB light strip light, linear light, no spot, light is more soft, no glare;
2. Fast heat dissipation, small light failure, longer life;
3. The lamp strip is formed by continuous glue injection, beautiful appearance, more in line with the definition of linear lighting;
4. Bending resistance, higher reliability;
5. Home decoration, advertising signs; Bridge, bar, KTV, nightclubs and other decorative lighting.



COB TWO-COLOR TEMPERATURE SERIES

1. uniform light, linear, no spot;
2. two color temperature, three kinds of light effect;
3. luminescent surface luminescent Angle can reach 180° ;
4. small size, compatible with all kinds of small space, installation, electronic products supporting.



COB-RGB SERIES

1. uniform light, linear, no spot;
2. RGB color luminescence;
3. fast heat dissipation, small light failure, longer life;
4. RGB light, color variety, suitable for a variety of occasions;
5. the lamp bead is dense, the luminous effect is beautiful, the lighting effect is good;
6. home decoration, advertising signs; Bridge, bar, KTV, nightclubs and other decorative lighting.



COB MONOCHROME SERIES

Product characteristics

1. COB light strip light, linear light, no spot, light is more soft, no glare;
2. fast heat dissipation, small light failure, longer life;
3. the lamp strip is formed by continuous glue injection, beautiful appearance, more in line with the definition of linear lighting;
4. bending resistance, higher reliability;
5. color temperature can choose 2700K, 3000K, 4000K, 5000K, 6000K, 6500K;
6. home decoration, advertising signs; Bridge, bar, KTV, nightclubs and other decorative lighting.

COB-12V (24V) 312LED-8mm

312
LED/M

8MM

12V
24V

5M
REEL

80
Lm/w

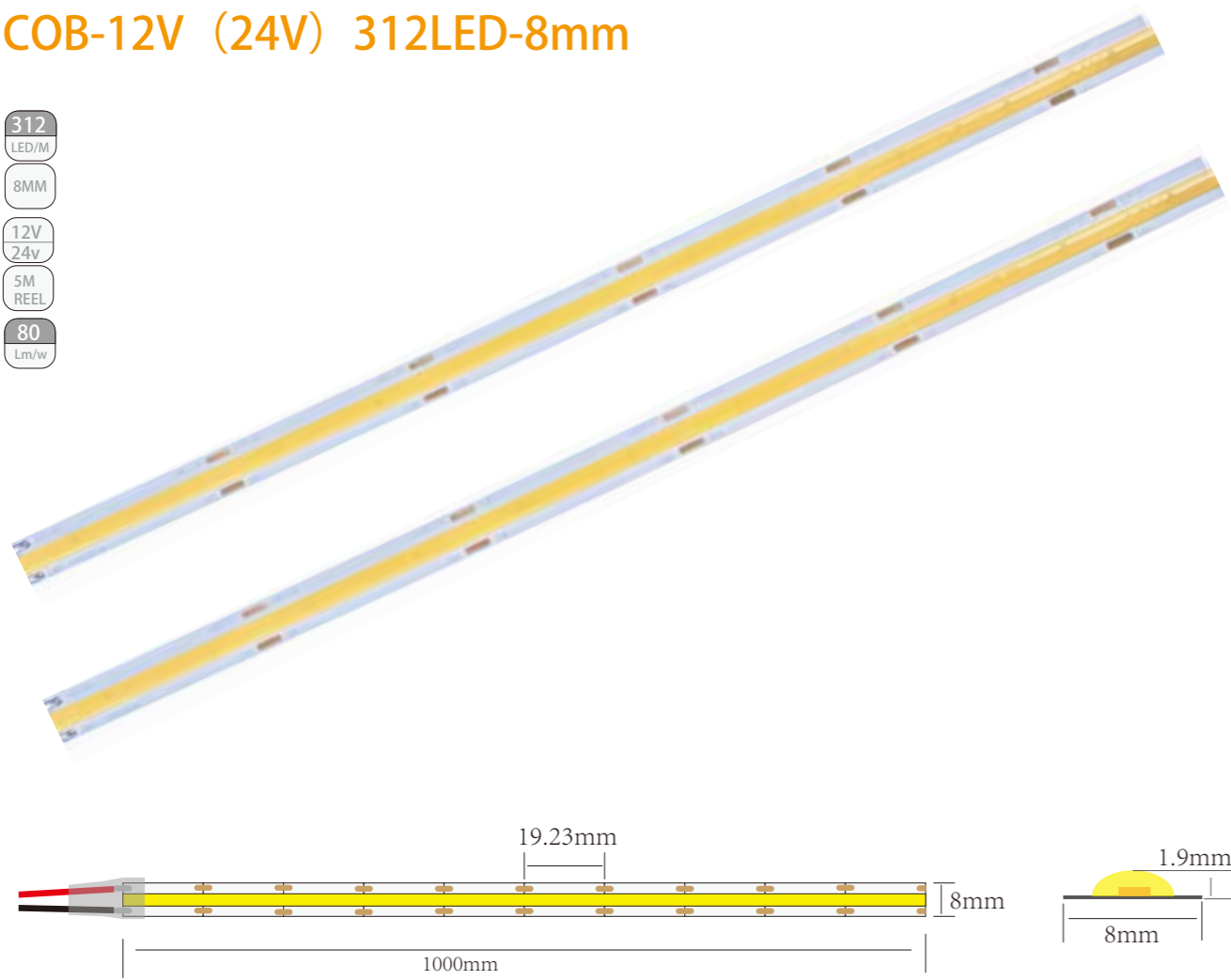

Product parameters

VOLTAGE: 12V/24V

CRI: >90

LED QTY: 312D/M

POWER: 11W/M

IP RATING: IP20

PCB PLATE WIDTH: 8MM

PCB COLOR: white

COLOR: 2700k、3000K、4000k、6000k

PACKAGING: 5M/R(Customizable length)

LIGHT EFFICIENCY: 80lm/w

LUMINOUS FLUX: 880lm

Other parameters

VOLTAGE	CUT SIZE
12V	19.23MM
24V	38.46MM

Product features

- 1.COBS light strip light strip linear light, no spot light spot, light more soft, no glare;
- 2.Fast heat dissipation, small light decline, longer life;
- 3.The lamp strip is formed by continuous glue injection, beautiful appearance, more in line with the definition of linear lighting;
- 4.Bending resistance, higher reliability;
- 5.Home decoration, advertising signs; Bridge, bar, KTV, nightclub and other decorative lighting.

COB-24V320LED-8mm

320
LED/M

8MM

24V

5M
REEL

100
Lm/w

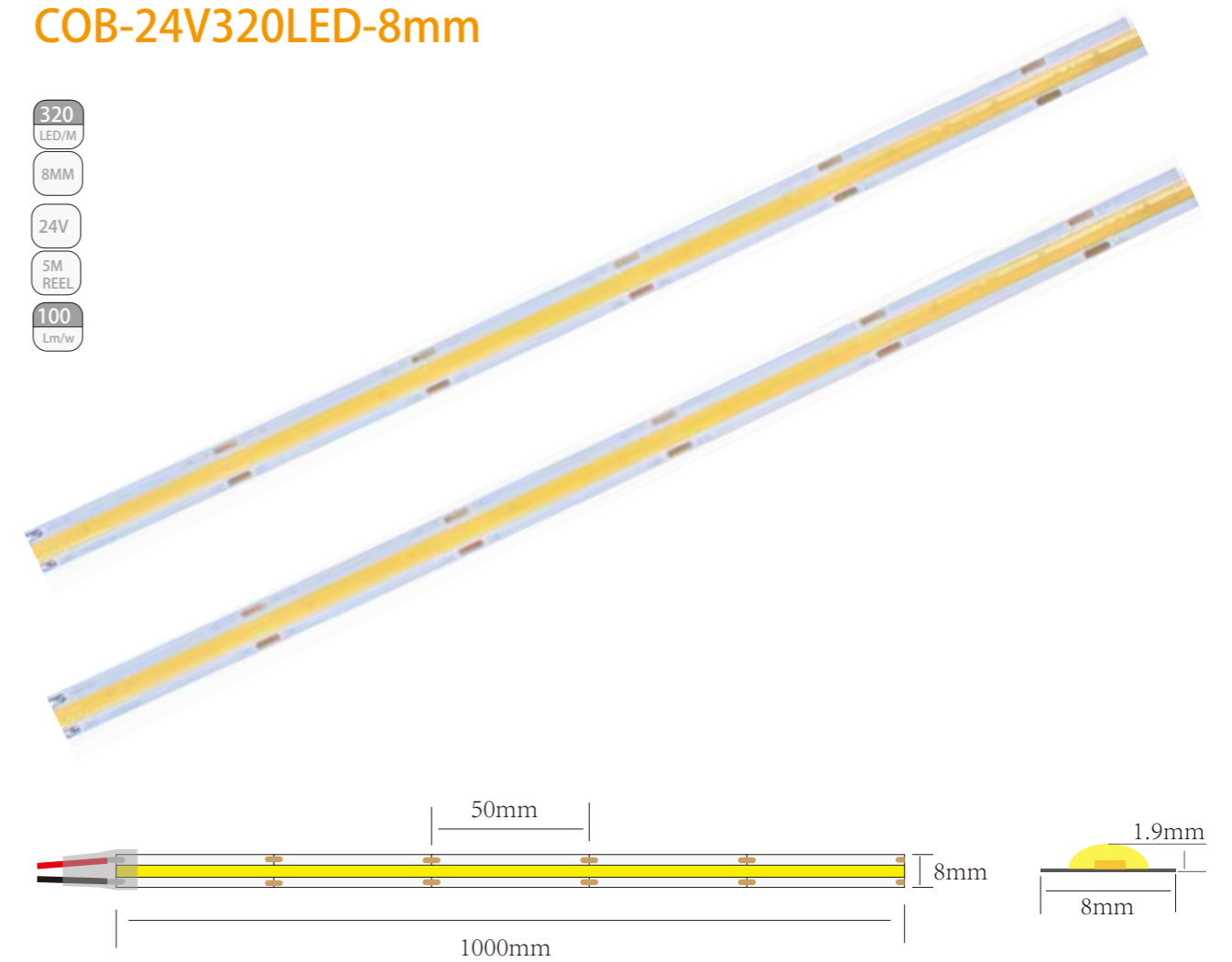

Product parameters

VOLTAGE: 5V/12V/24V

CRI: >90

LED QTY: 320D/M

POWER: 8W/M

IP RATING: IP20

PCB PLATE WIDTH: 8MM

PCB COLOR: WHITE

COLOR: 2700k、3000K、4000k、6000k

PACKAGING: 5M/R(Customizable length)

Other parameters

voltage	Light efficiency	Luminous flux	pcb size	cut size
5V	>80Lm/w	640Lm	10MM	50MM
12V	>100Lm/w	800Lm	8MM	25MM
24V	>100Lm/w	800Lm	8MM	50MM

Product features

- 1, uniform light, linear, no spot;
- 2, fast heat dissipation, small light failure, longer life;
- 3, luminescent surface luminescent Angle can reach 180° ;
- 4, home decoration, advertising signs; Bridges, bars, karaoke bars,nightclubs and other decorative lighting.

COB-24V384LED-8mm

384
LED/M
8MM
24V
5M
REEL
100
Lm/w

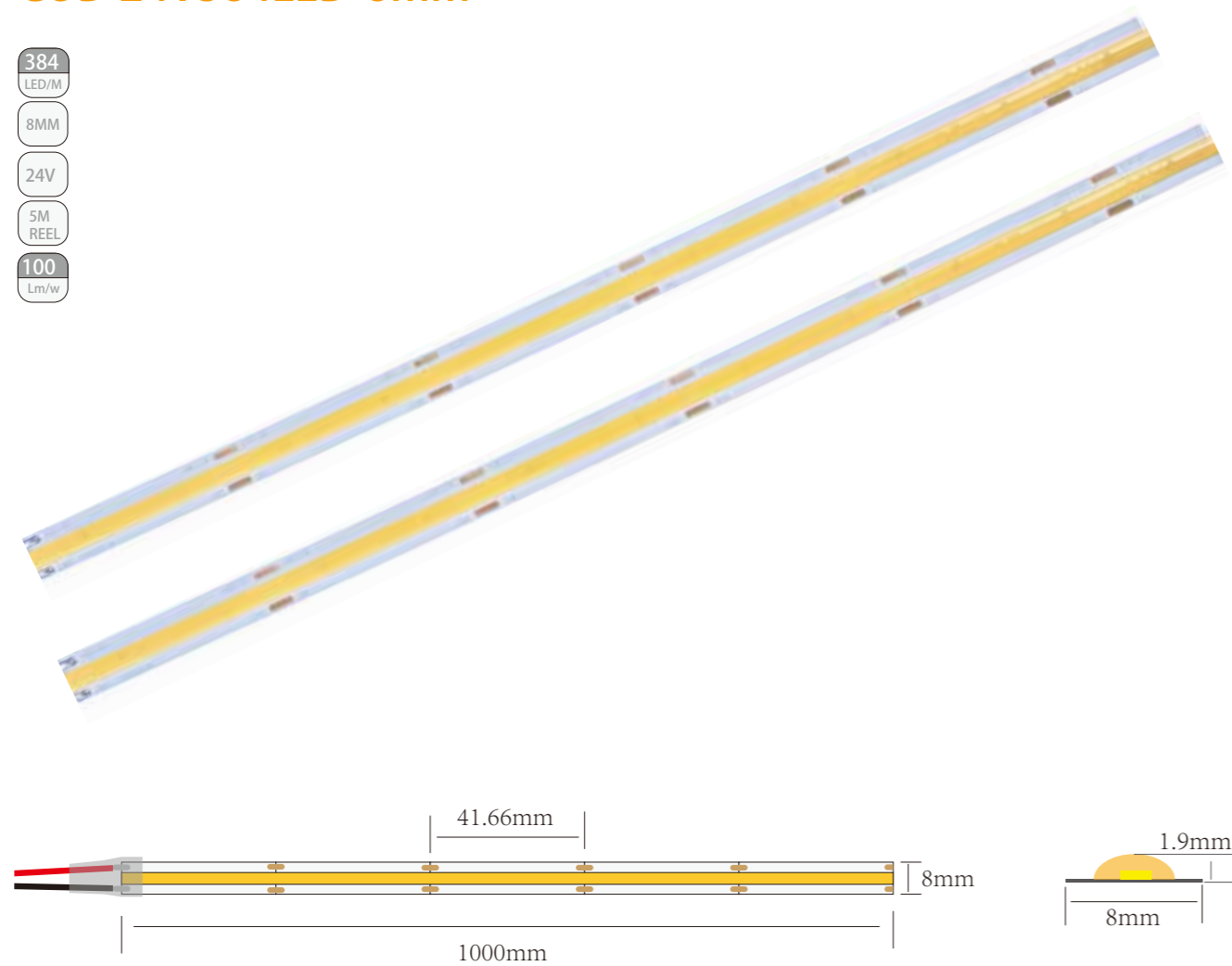

Product parameters

Product voltage: 12V/24V
CRI: >90
LED QTY: 384D/M
Power: 10 w/M
IP Rating: IP20
PCB plate width: 5/8 mm
PCB color: white
Color temperature: 2700K, 3000K, 4000K, 6000K
Package: 5M/R(customizable length)
Light effect: 100 lm/w
Optical flux: 1000lm

Glowing effect

type	width	Voltage	5 meters finished weight
384led	8mm	12V/24V	0.091kg
384led (No pressure drop)	8mm	12V	0.091kg
384led	5mm	12V/24V	0.087kg

Product features

- 1, COB light strip light, linear light, no spot, light is more soft, no glare;
- 2, fast heat dissipation, small light failure, longer life;
- 3, the lamp strip is formed by continuous glue injection, beautiful appearance, more in line with the definition of linear lighting;
- 4, home decoration, advertising signs; Bridge, bar, KTV, nightclubs and other decorative lighting.

COB-12V480LED-8mm

480
LED/M
8MM
12V
5M
REEL
100
Lm/w

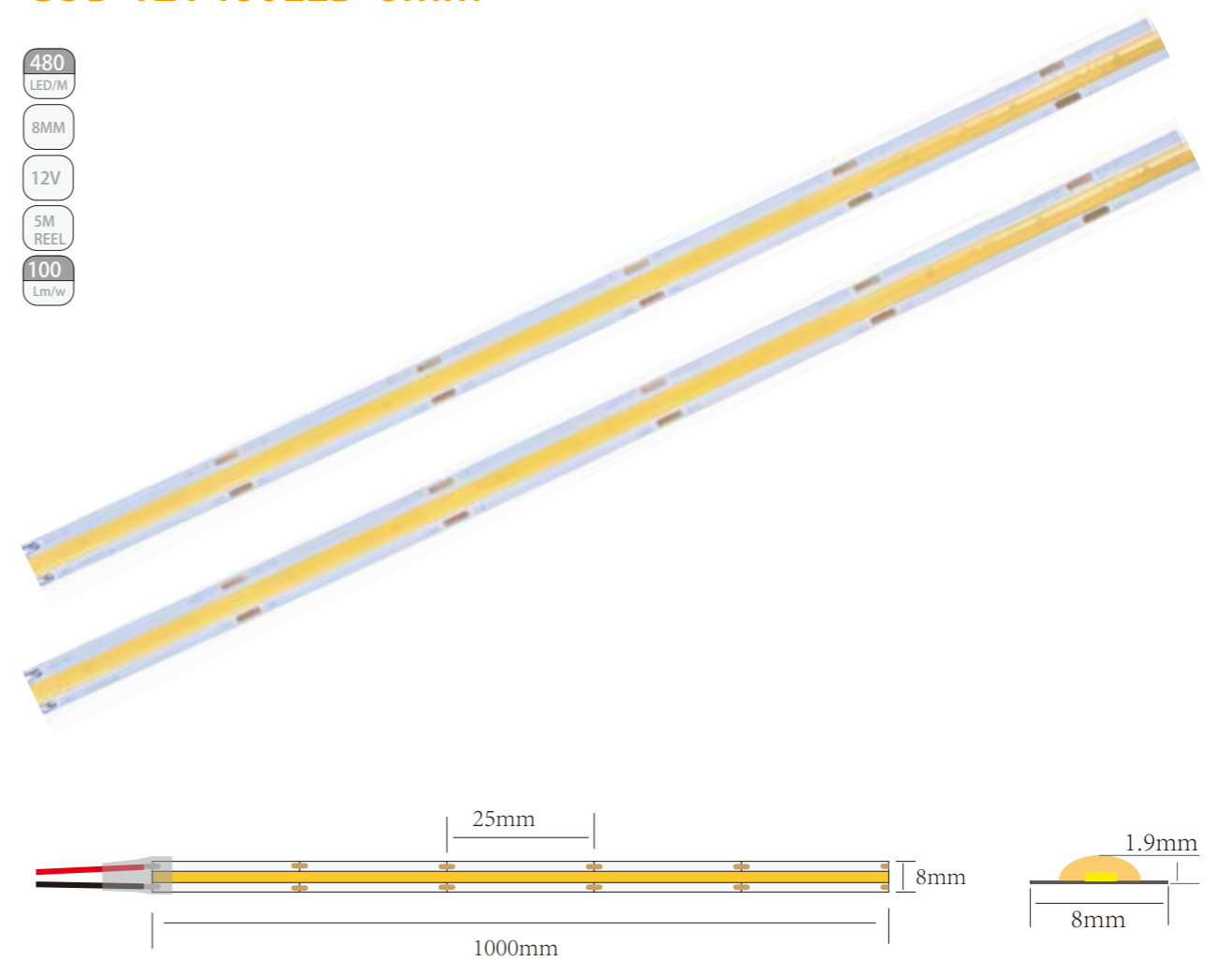

Product parameters

Product voltage: 12V/24V
CRI: >90
LED QTY: 480D/M
Power: 10 w/M
IP Rating: IP20
PCB plate width: 8 mm
PCB color: white
Color temperature: 2700K, 3000K, 4000K, 6000K
Package: 5M/R(customizable length)
Light effect: 100 lm/w
Optical flux: 1000lm

Glowing effect

Voltage	Cut size
12V	25MM
24V	50MM

Product features

- 1, COB light strip light, linear light, no spot, light is more soft, no glare;
- 2, fast heat dissipation, small light failure, longer life;
- 3, the lamp strip is formed by continuous glue injection, beautiful appearance, more in line with the definition of linear lighting;
- 4, home decoration, advertising signs; Bridge, bar, KTV, nightclubs and other decorative lighting.

COB-12V24V528LED-10mm

520
LED/M

10MM

12V
24V

5M
REEL

100
Lm/w

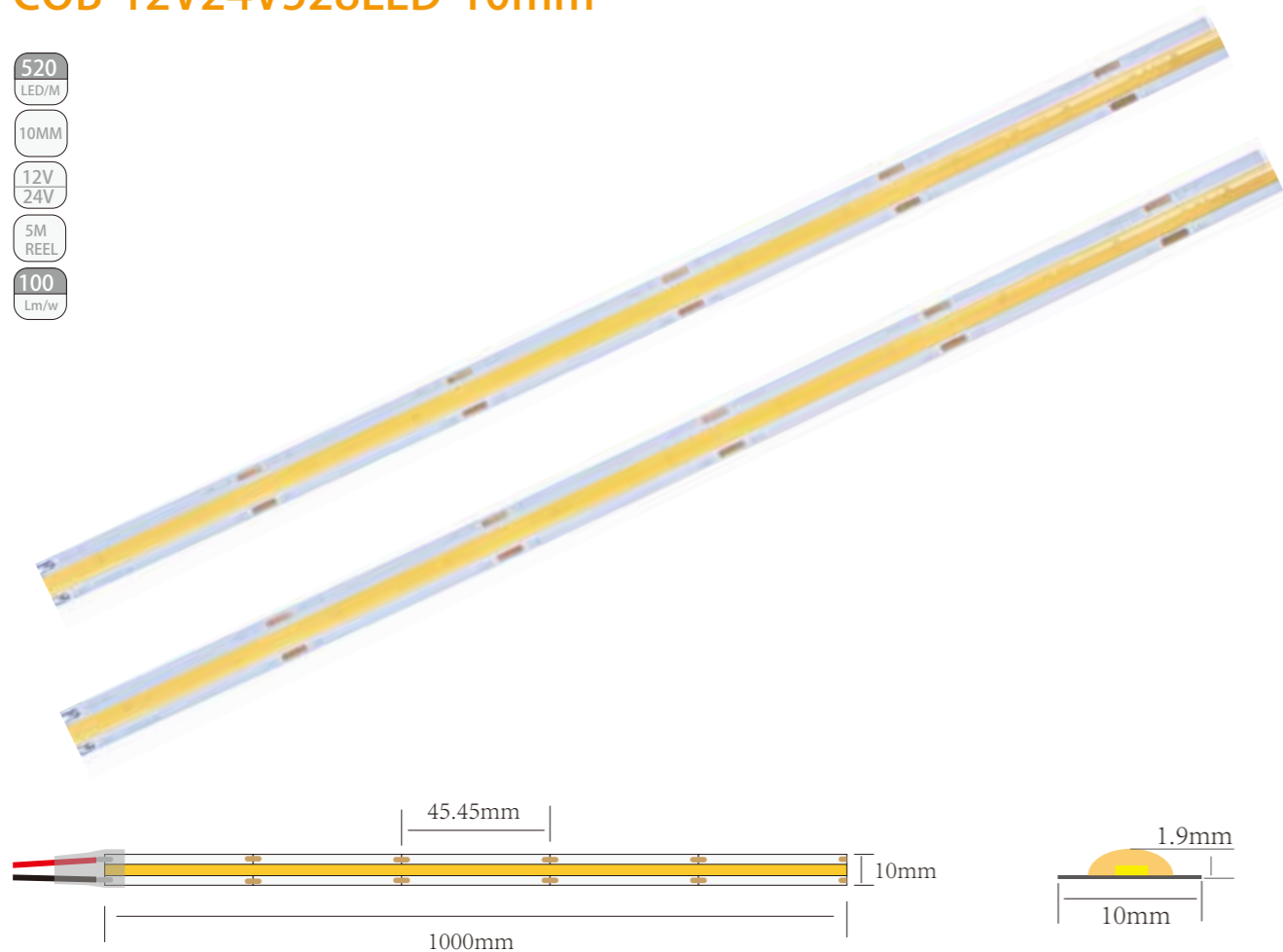

Product parameters

Product voltage: 12V/24V

CRI: >90

LED QTY: 528D/M

Power: 14 w/M

IP Rating: IP20

PCB plate width: 10 mm

PCB color: white

Color temperature: 2700K, 3000K, 4000K, 6000K

Package: 5M/R(customizable length)

Light effect: 100 lm/w

Optical flux: 1400lm

Glowing effect

Voltage	Cut size
12V	45.45MM
24V	45.45MM

Product features

- 1, COB light strip light, linear light, no spot, light is more soft, no glare;
- 2, fast heat dissipation, small light failure, longer life;
- 3, the lamp strip is formed by continuous glue injection, beautiful appearance, more in line with the definition of linear lighting;
- 4, home decoration, advertising signs; Bridge, bar, KTV, nightclubs and other decorative lighting.

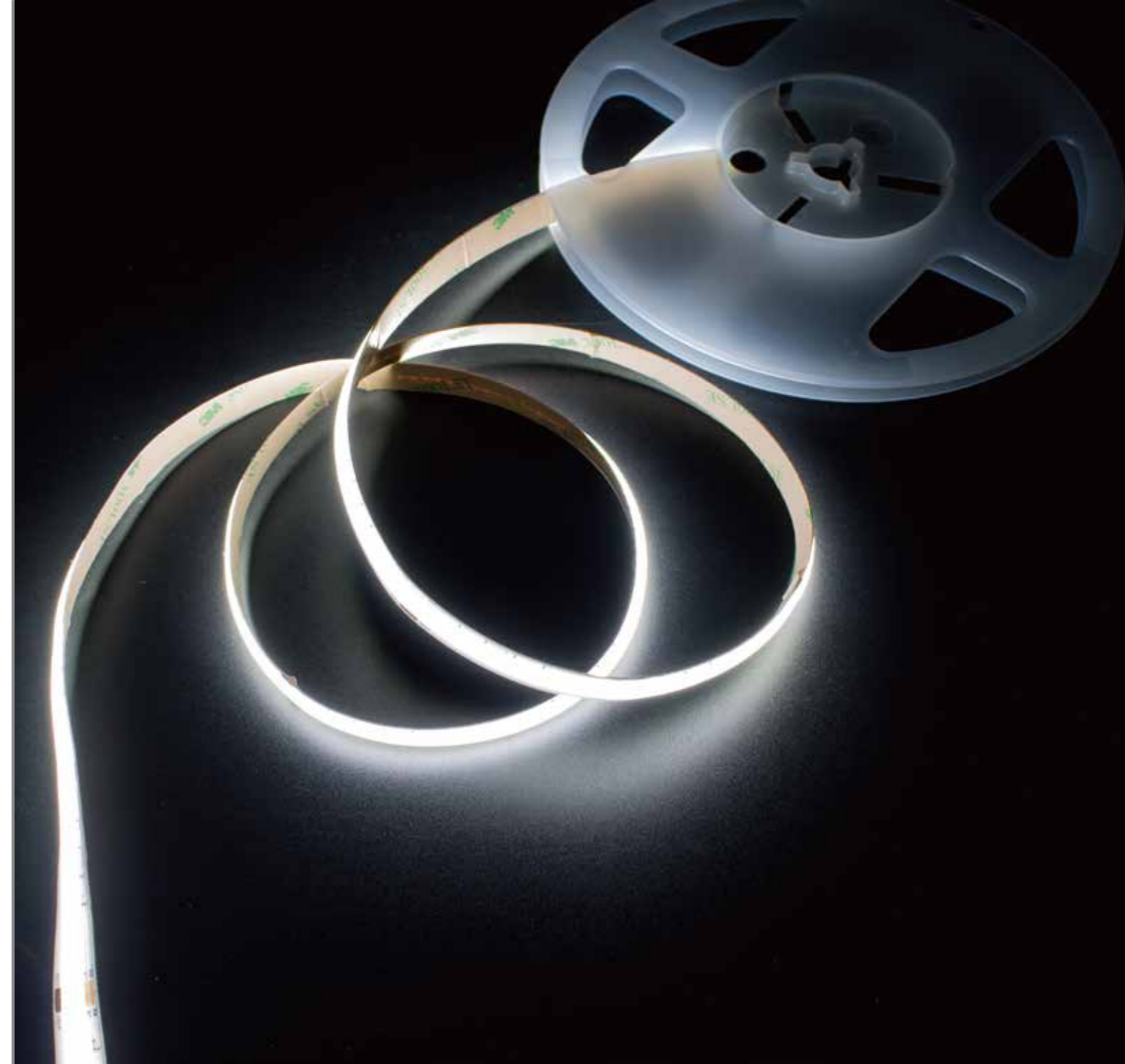

COB TWO-COLOR TEMPERATURE SERIES

Product features

- 1.uniform light, linear, no spot;
- 2.two color temperature, three kinds of light effect;
- 3.luminescent surface luminescent Angle can reach 180° ;
- 4.the lamp strip is formed by continuous glue injection, beautiful appearance, more in line with the definition of linear lighting;
- 5.bending resistance, can be used to fold a variety of shapes, higher reliability;
- 6.home decoration, advertising signs; Bridge, bar, KTV, nightclubs and other decorative lighting.

COB-12V24V600LED-5mm

600
LED/M

5MM

24V
12V

5M
REEL

7+7
w/m

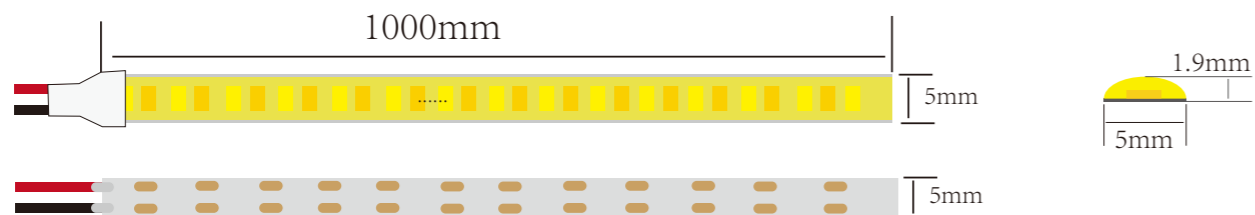

Product parameters

Product number: C600-7+ 7W-5mm

Product voltage: 12V/24V

CRI: >90

LED QTY: 600D/M

Power: 7 + 7 w/M

IP Rating: IP20

PCB plate width: 5 mm

PCB color: white

Color temperature: dual color temperature

Package: 5M/R(customizable length)

Light effect: 100 lm/w

Optical flux: 700+700lm

Glowing effect

Two color temperature effect Voltage Cut size



Product features

- 1.uniform light, linear, no spot;
- 2.two-color temperature, , three kinds of light effect;
- 3.luminescent surface luminescent Angle can reach 180° , lamp bead dense,beautiful luminous effect, good lighting effect;
- 4.home decoration, advertising signs; Bridges, bars, karaoke bars,nightclubs and other decorative lighting.

COB-12V24V608LED-10mm

608
LED/M

IP20

24V
12V

5M
REEL

100
Lm/w



Product parameters

Product Number: C608-7+ 7W-10mm

Product voltage: 12V/24V

CRI: >90

LED QTY: 608D/M

Power: 7 + 7 w/M

IP Rating: IP20

PCB plate width: 10 mm

PCB color: white

Color temperature: dual color temperature

Package: 5M/R(customizable length)

Light effect: 100 lm/w

Optical flux: 700+700lm

Glowing effect

Two color temperature effect Voltage Cut size



Product features

- 1.uniform light, linear, no spot;
- 2.two-color temperature, , three kinds of light effect;
- 3.luminescent surface luminescent Angle can reach 180° , lamp bead dense,beautiful luminous effect, good lighting effect;
- 4.home decoration, advertising signs; Bridges, bars, karaoke bars,nightclubs and other decorative lighting.

COB-24V640LED-10mm

640
LED/M

IP20

24V
12V

5M
REEL

100
Lm/w



Product parameters

Product Number: C640-24V15W-10MM

Product voltage: 12V/24V

CRI: >90

LED QTY: 640D/M

Power: 15 w/M

IP Rating: IP20

PCB plate width: 10 mm

PCB color: white

Color temperature: dual color temperature

Package: 5M/R(customizable length)

Light effect: 100 lm/w

Optical flux: 1500lm

Glowing effect

Two color temperature effect Voltage Cut size

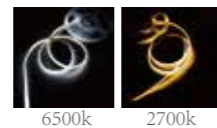

24V 50mm

Product features

- 1.uniform light, linear, no spot;
- 2.two-color temperature, , three kinds of light effect;
- 3.luminescent surface luminescent Angle can reach 180° , lamp bead dense,beautiful luminous effect, good lighting effect;
- 4.home decoration, advertising signs; Bridges, bars, karaoke bars,nightclubs and other decorative lighting.



COB-RGB SERIES

Product features

- 1.uniform light, linear, no spot;
- 2.RGB color luminescence;
- 3.fast heat dissipation, small light failure, longer life;
- 4.RGB light, color variety, suitable for a variety of occasions;
- 5.the lamp bead is dense, the luminous effect is beautiful, the lighting effect is good;
- 6.home decoration, advertising signs; Bridge, bar, KTV, nightclubs and other decorative lighting.

COB-576LED-RGB-10mm

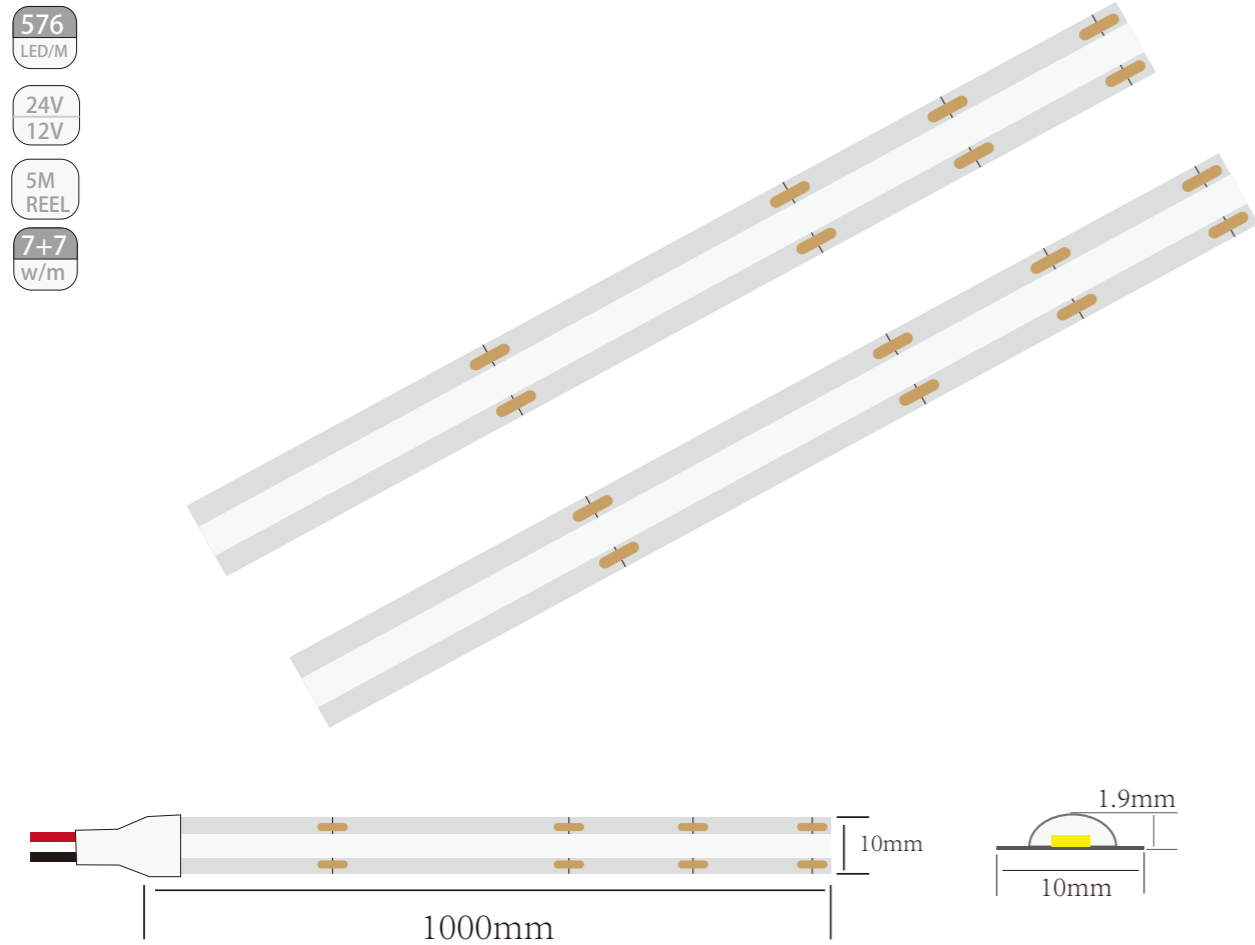

Product parameters

Product No. : C576RGB-10MM
 Product voltage: 12V/24V
 CRI: >90
 LED QTY: 576D/M
 Power: 14W/M
 IP Rating: IP20
 PCB plate width: 10 mm
 PCB color: white
 Color temperature: RGB
 Package: 5M/R(customizable length)
 Light effect: 100 lm/w
 Optical flux: 1400lm

Glowing effect



Product features

- 1.uniform light, linear, no spot;
- 2.fast heat dissipation, small light failure, longer life;
- 3.RGB light, color variety, suitable for a variety of occasions;
- 4.the lamp bead is dense, the luminous effect is beautiful, the lighting effect is good;
- 5.home decoration, advertising signs; Bridges, bars, karaoke bars,nightclubs and other decorative lighting.

COB-24V840LED-10mm

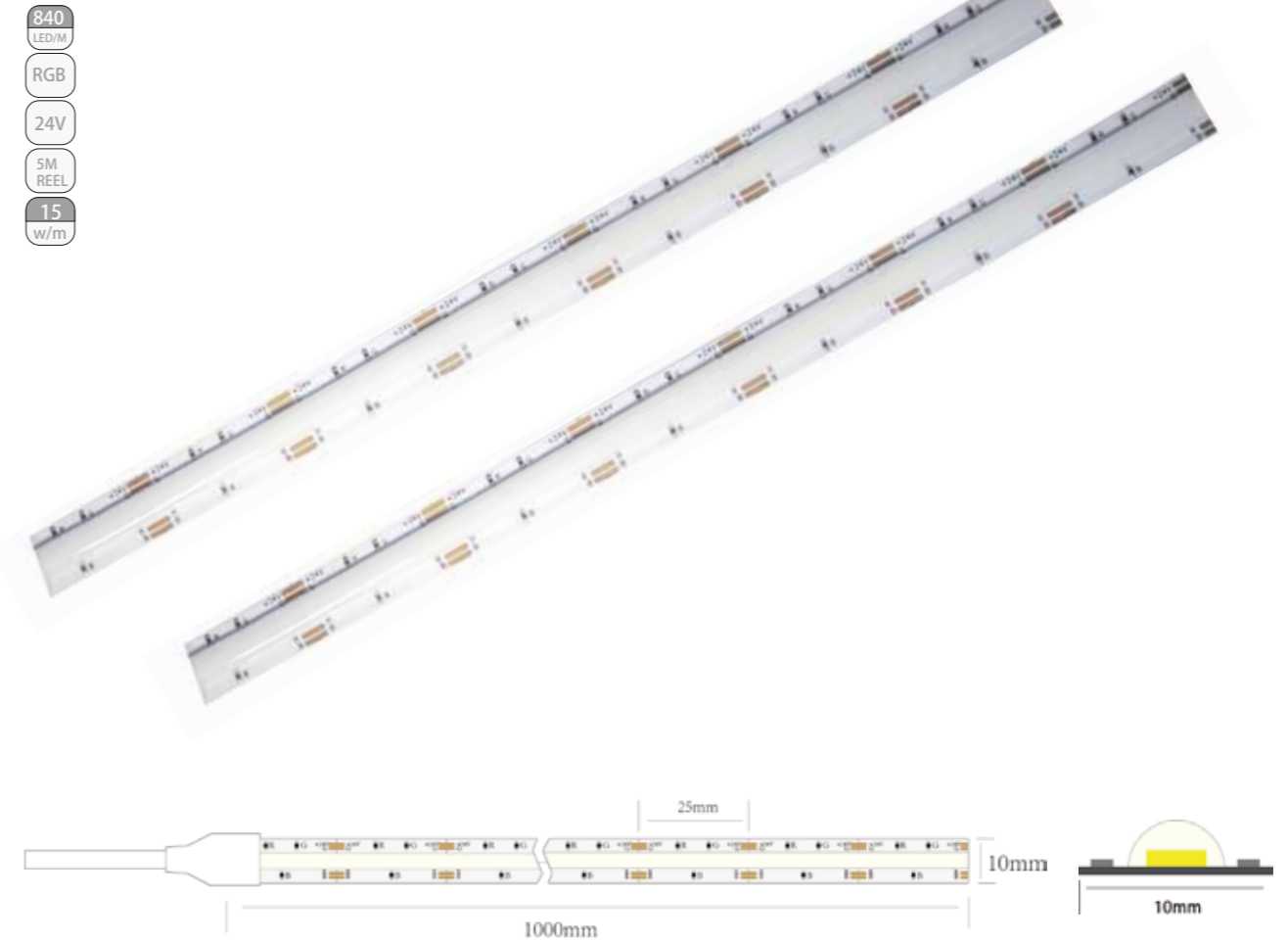

Product parameters

Product No. : C840-24VRGB-10mm
 Product voltage: 12V/24V
 CRI: >90
 LED QTY: 840D/M
 Power: 15W/M
 IP Rating: IP20
 PCB plate width: 10 mm
 PCB color: white
 Color temperature: RGB
 Package: 5M/R(customizable length)
 Light effect: 100 lm/w
 Optical flux: 1500lm

Glowing effect



Product features

- 1.uniform light, linear, no spot;
- 2.fast heat dissipation, small light failure, longer life;
- 3.RGB light, color variety, suitable for a variety of occasions;
- 4.the lamp bead is dense, the luminous effect is beautiful, the lighting effect is good;
- 5.home decoration, advertising signs; Bridges, bars, karaoke bars,nightclubs and other decorative lighting.



ADDRESSABLE LED STRIP SERIES

- Single point single control, built-in or external chip, programmable light strip
- It can be used with most controllers, and has the advantages of convenient programming, high brightness, energy saving, long service life and so on
- Suitable for the production of LED display, advertising board, KTV, bar lighting decoration.

Addressable light strip solution

The length of a single low-voltage lamp belt cannot exceed 5 meters. If the length exceeds 5 meters, additional lap power cables are required. The controller has different pixels to choose from, and the light belt beyond the controller pixel cannot control the excess part.

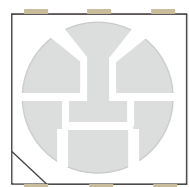
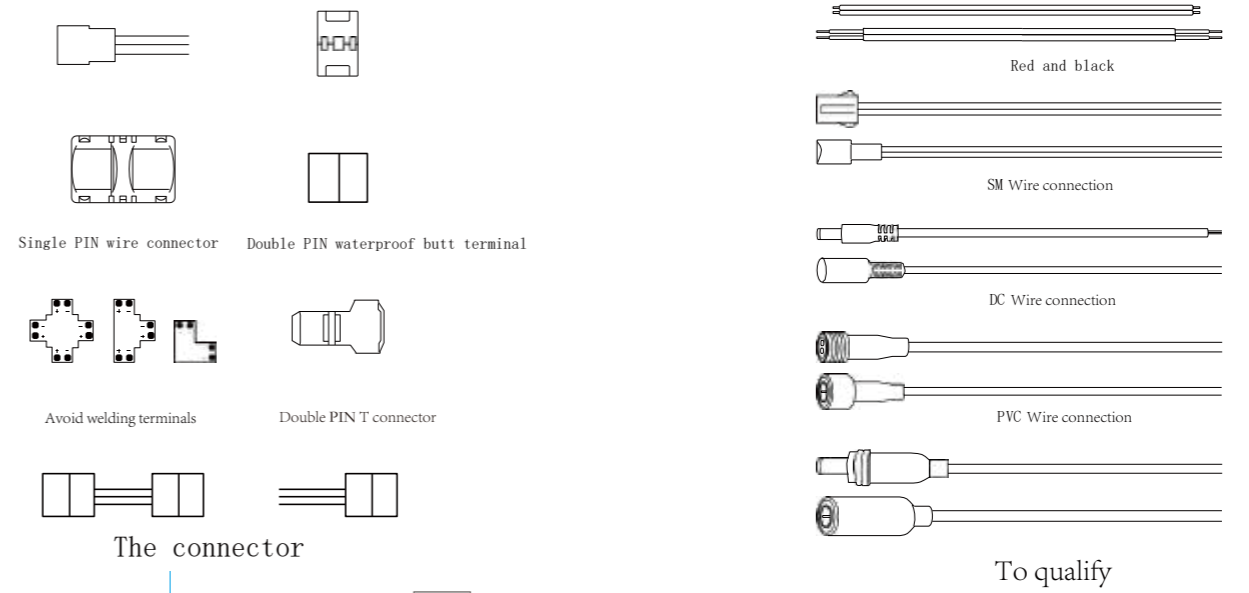
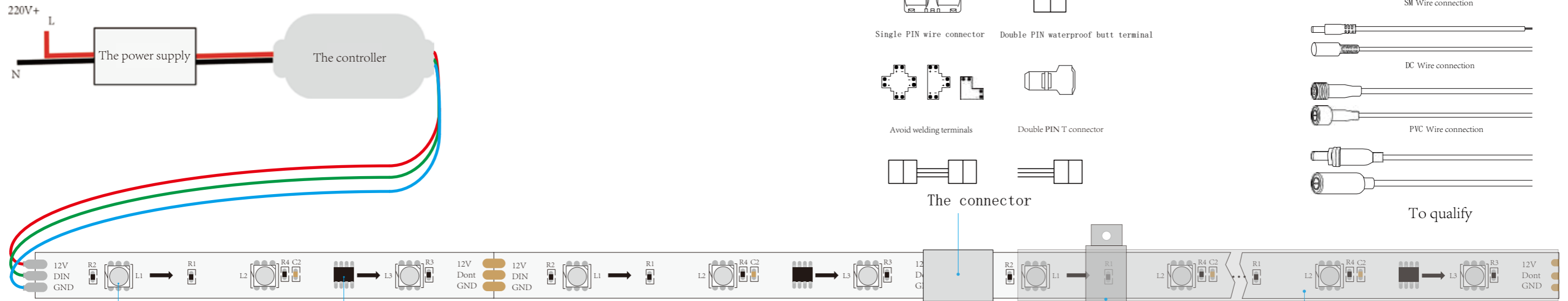

LED

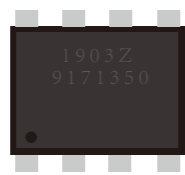

IC

Control effect, magic color drive



Simple controller type



按键控制器 遥控器 遥控器 1-8米 可连接手机蓝牙

installation

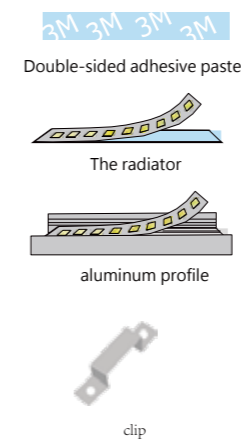

Protection technology

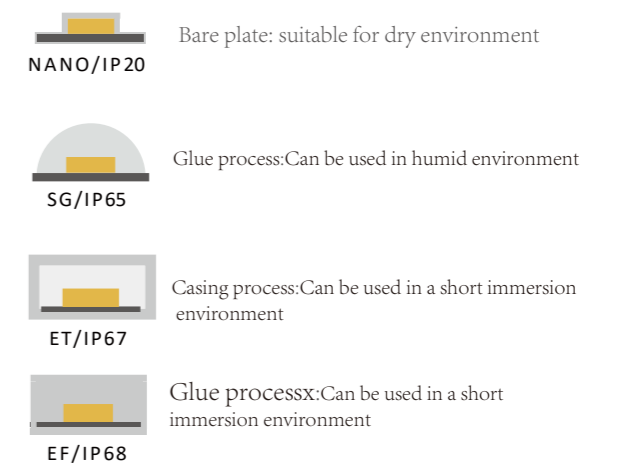







2811 SERIES

1. Using RGB lamp beads, external WS2811 IC chip, make it into a programmable lamp belt.
2. It can be made into a variety of waterproof effects, such as dripping waterproof, sheath waterproof, and rubber injection waterproof inside the sleeve. Make it available for use in most places.
3. can achieve a variety of lighting effects through controller programming, can be applied to different scenes.
4. Ws2811 is a single point single control light belt with highly consistent light colors. It is a cost-effective light belt.



2812 SERIES

1. single point single control, built-in chip, programmable light belt;
2. It is easy to program and can be used with most controllers.
3. high brightness, energy saving, long service life;
4. suitable for the production of LED display, advertising board, KTV, bar lighting decoration, etc.;
5. it can be through a signal line, two power lines to control the built-in IC lamp beads display to achieve text, pictures, animation and other arbitrary effects.



2813 SERIES

1. WS2813LED inner seal IC and breakpoint continuous transmission;
2. All components are integrated in the 5050 package, without any other peripheral components to form a complete external control pixel;
3. intelligent reverse connection protection, 5V power supply will not damage the components;
4. built-in signal shaping circuit, any pixel after receiving the signal through waveform shaping output, to ensure that the line waveform distortion will not accumulate;
5. break point continuation, in the case of damage to a single pixel, does not affect the overall display effect;
6. any two point transmission distance is not more than 5 meters without adding any circuit.



2815 SERIES

- 1, WS2815 full color light strip with low power consumption, 12V power supply, low voltage drop.
- 2, serial connection port, double signal line transmission, to achieve the function of breakpoint continued transmission, where a single pixel damage will not cause other pixels to light up normally, does not affect the overall effect.
- 3, any two point transmission distance is not more than 5 meters without adding any circuit.



2818 SERIES





























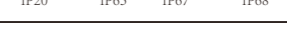
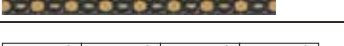























- 1, WS2818b external IC and resumable breakpoint, resumable breakpoint, in the case of a single pixel damage, does not affect the overall display effect
2. All components are integrated in the 5050 package, without any other peripheral components to form a complete external control pixel;
- 3, intelligent reverse connection protection, 5V power supply will not damage the components;
- 4, three channel LED drive control special circuit;
- 5, any two point transmission distance is not more than 5 meters without adding any circuit.

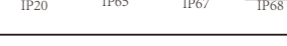

2020 SERIES

1. Board width 4mm compatible with all kinds of small space, installation, electronic products supporting;
2. 120 pixels/meter, full color lamp beads, lamp beads dense, luminous effect beautiful;
3. Good conductivity, fast heat dissipation;
4. Often used for advertising signs, hotels, KTV, etc

The list of addressable light strip

IC type	Product Number	Voltage (V)	power (w/m)	color	LED QTY	cut size	width (mm)	package (m/R)	Protection technology	graphic
2811	12V2811-30D	12V	6		30	3led/100mm	10	5		
	12V2811-60D	12V	12		60	3led/50mm	10	5		
2812	5V2812-30D	5V	6		30	1led/33.3mm	10	5		
	5V2812-60D	5V	12		60	1led/16.6mm	10	5		
	5V2812-72D	5V	14.4		72	1led/13.8mm	10	5		
	5V2812-96D	5V	19.2		96	1led/10.4mm	10	5		
	5V2812-144D	5V	28.8		144	1led/6.94mm	12	5		
	5V2812-60D-RGBW	5V	12		60	1led/16.6mm	10	5		
2813	5V2813-30D	5V	6		30	1led/33.3mm	10	5		
	5V2813-60D	5V	12		60	1led/16.6mm	10	5		
	5V2813-144D	5V	28.8		144	1led/6.94mm	12	5		
2815	12V2815-30D	12	6		30	1led/33.3mm	10	5		
	12V2815-60D	12	12		60	1led/16.6mm	10	5		
	12V2815-144D	12	28.8		144	1led/6.94mm	12	5		
2818	12V2818-30D	12V	6		30	3led/100mm	10	5		
	12V2818-60D	12V	12		60	3led/50mm	10	5		
	12V2818-60D-W	12V	12		60	3led/50mm	10	5		
2020	5V2020-120D	5V	24		120	1led/8.33mm	4	5		



12V2811-30LED

6 w/m 30 LED/M RGB 12V 5M REEL 10 MM

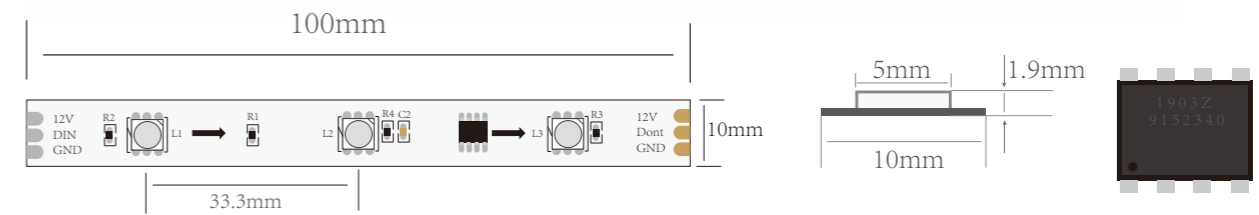

Product parameters

Product number:12V2811-30LED

Bead type:SMD5050

IC type:WS2811

Number of beads:30D/M

Power:6w/m

Voltage:12V

IP Rating:IP20/IP65/IP67/IP68

Cutting size:100mm

Color temperature:RGB

PCB board width:10mm

PCB color:black/white

Welding points:3

Package:5M/R (customizable length)

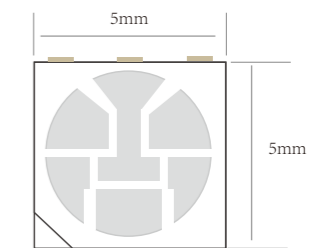

Product features

- 1.Three channel LED drive control special circuit
- 2.External use of ICws2811, 5050RGB lamp beads
- 2.10 pixels/m, full color beads
3. Good conductivity, fast heat dissipation
- 4.Often used for advertising signs, hotels, KTV, etc

2811 SERIES



12V2811-30led



12V2811-60led

12V2811-60LED

12 w/m 60 LED/M RGB 12V 5M REEL 10 MM

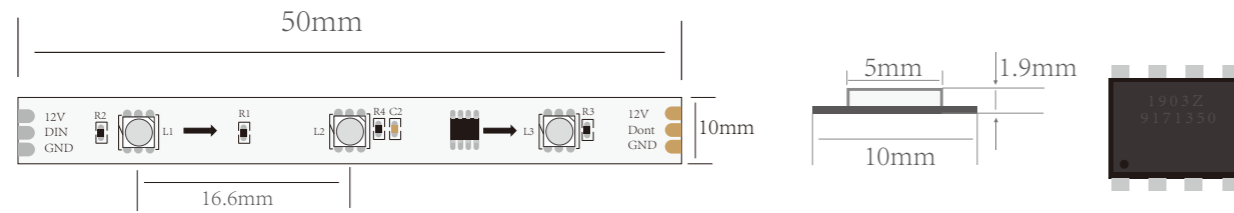

Product parameters

- Product number:12V2811-60LED
- Bead type:SMD5050
- IC type:WS2811
- Number of beads:60D/M
- Power:12w/m
- Voltage:12V
- IP Rating:IP20/IP65/IP67/IP68
- Cutting size:50mm
- Color temperature:RGB
- PCB board width:10mm
- PCB color:black/white
- Welding points:3
- Package:5M/R (customizable length)

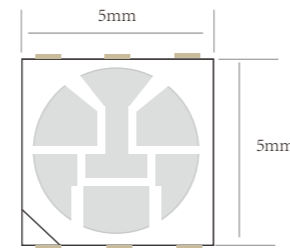

Product features

- 1.Three channel LED drive control special circuit
- 2.External use of ICws2811, 5050RGB lamp beads
- 2.20 pixels/m, full color beads
3. Good conductivity, fast heat dissipation
- 4.Often used for advertising signs, hotels, KTV, etc

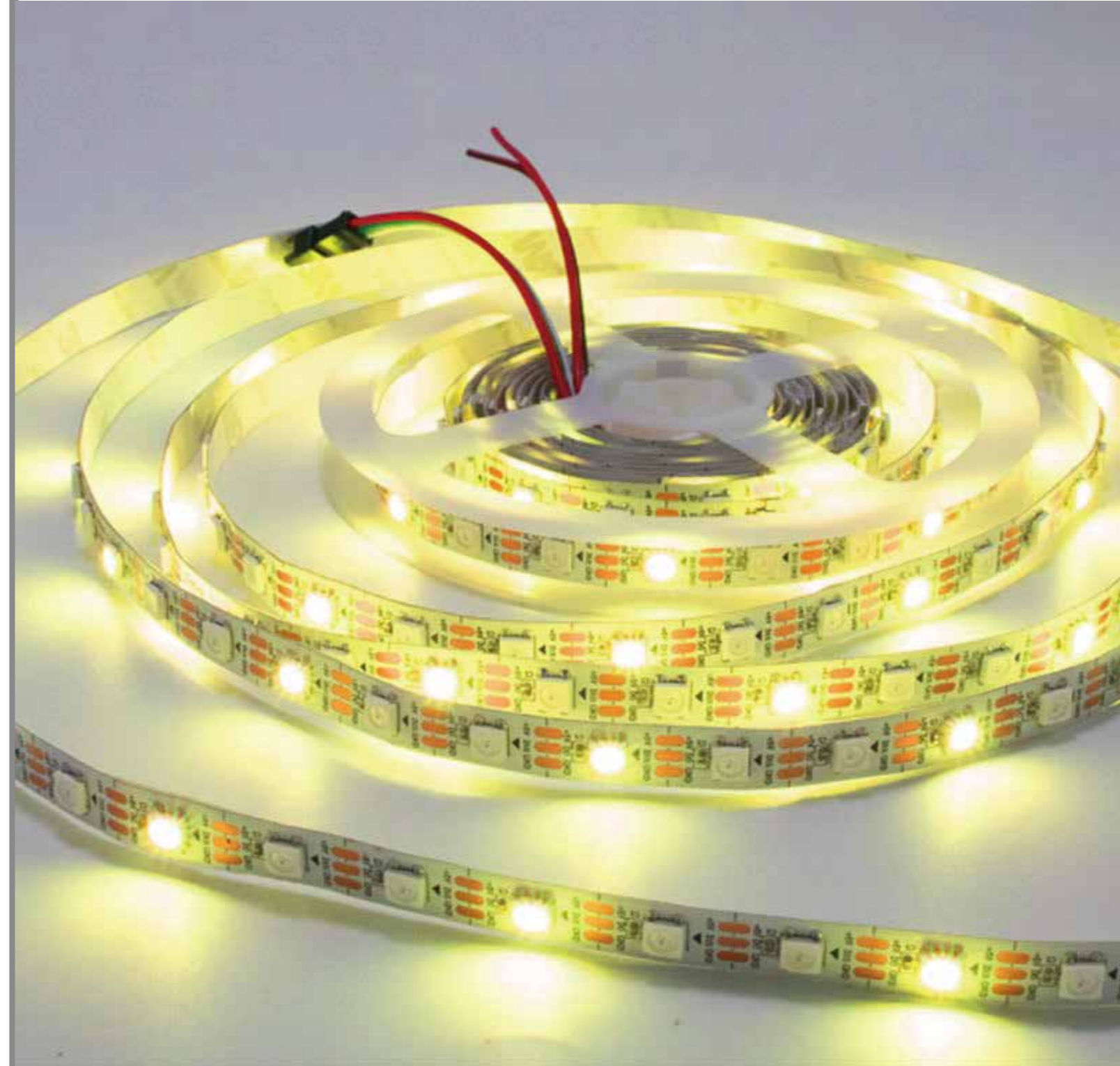

2812 SERIES



5V2812-30LED



5V2812-60LED



5V2812-72LED



5V2812-96LED



5V2812-144LED



5V2812RGBW-60LED

5V2812-30LED

6 w/m 30 LED/M RGB 5V 5M REEL 10 MM

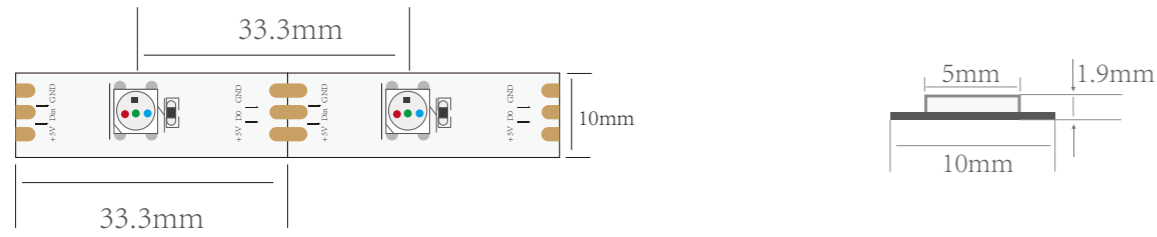

Product parameters

Product number:5V2812-30LED
 Bead type:SMD5050
 IC type:ws2812b
 Number of beads:30D/M
 Power:6w/m
 Voltage:5V
 IP Rating:IP20/IP65/IP67/IP68
 Cutting size:33.3mm
 Color temperature:RGB
 PCB board width:10mm
 PCB color:black/white
 Welding points:3
 Package:5M/R (customizable length)

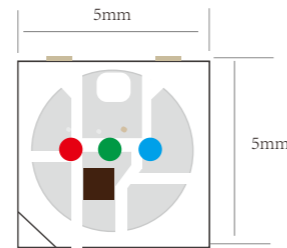

Product features

1. three channel LED drive control special circuit
2. the use of built-in ICws2812,5050RGB lamp beads
2. 30 pixels/meter, full color lamp beads
3. good conductivity, fast heat dissipation
4. often used for advertising signs, hotels, KTV, etc

5V2812-60LED

12 w/m 60 LED/M RGB 5V 5M REEL 10 MM

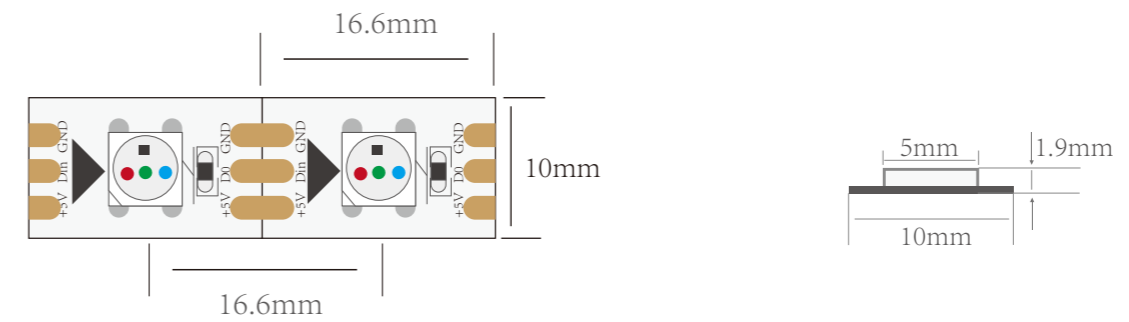

Product parameters

Product number:5V2812-60LED
 Bead type:SMD5050
 IC type:ws2812b
 Number of beads:60D/M
 Power:12w/m
 Voltage:5V
 IP Rating:IP20/IP65/IP67/IP68
 Cutting size:16.6mm
 Color temperature:RGB
 PCB board width:10mm
 PCB color:black/white
 Welding points:3
 Package:5M/R (customizable length)

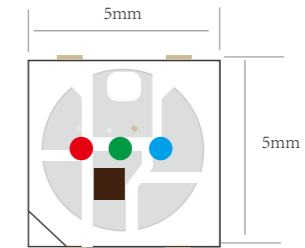

Product features

1. A lamp a cut ultra-short cutting size, small space installation more fit, no waste;
2. Flexible tailoring, improve the utilization rate;
3. Can be freely bent, can be arbitrarily fixed on the convex and concave surface, compact size, rich color;
4. 60 pixels/meter, full color lamp beads;
5. Often used for advertising signs, hotels, KTV, etc.

5V2812-72LED

14.4 w/m 72 LED/M RGB 5V 5M REEL 10 MM

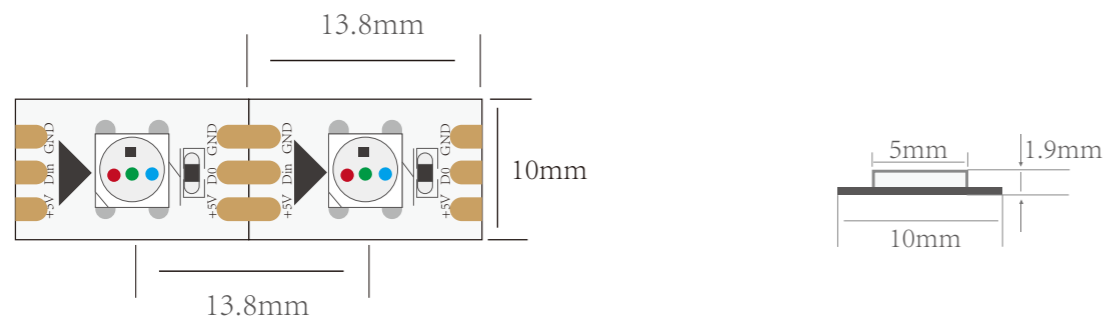

Product parameters

Product number:5V2812-72LED
 Bead type:SMD5050
 IC type:ws2812b
 Number of beads:72D/M
 Power:14.4w/m
 Voltage:5V
 IP Rating:IP20/IP65/IP67/IP68
 Cutting size:13.8mm
 Color temperature:RGB
 PCB board width:10mm
 PCB color:black/white
 Welding points:3
 Package:5M/R (customizable length)

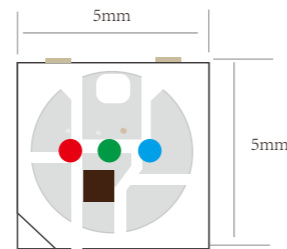

Product features

1. A lamp a cut ultra-short cutting size, small space installation more fit, no waste;
2. Flexible tailoring, improve the utilization rate;
3. Can be freely bent, can be arbitrarily fixed on the convex and concave surface, compact size, rich color;
- 472 pixels/meter, full color lamp beads;
5. Often used for advertising signs, hotels, KTV, etc.

5V2812-96LED

19.2 w/m 96 LED/M RGB 5V 5M REEL 10 MM

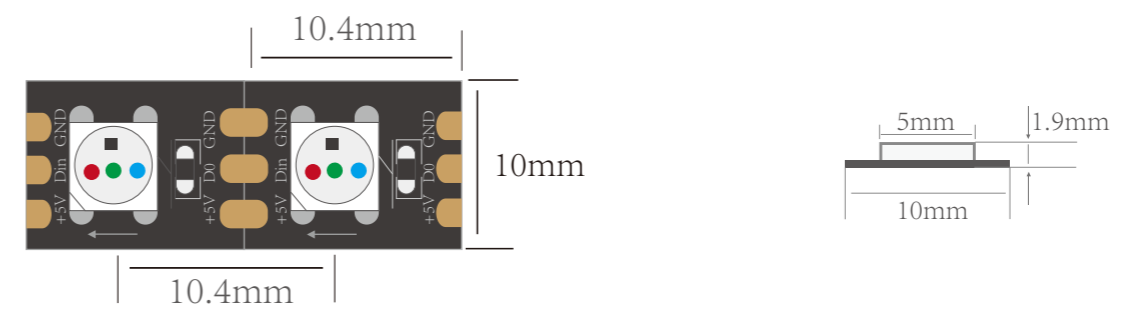

Product parameters

Product number:5V2812-96LED
 Bead type:SMD5050
 IC type:ws2812b
 Number of beads:96D/M
 Power:19.2w/m
 Voltage:5V
 IP Rating:IP20/IP65/IP67/IP68
 Cutting size:10.4mm
 Color temperature:RGB
 PCB board width:10mm
 PCB color:black/white
 Welding points:3
 Package:5M/R (customizable length)

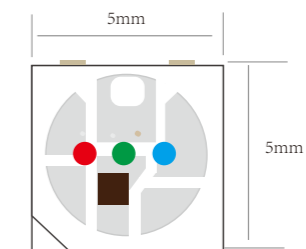

Product features

1. Three channel LED drive control special circuit.
2. 96 pixels/meter, full colored beads.
3. Good conductivity, fast heat dissipation.
4. Often used for advertising signs, hotels, KTV, etc.

5V2812-144LED

28.8 w/m 144 LED/M RGB 5V 5M REEL 12 MM

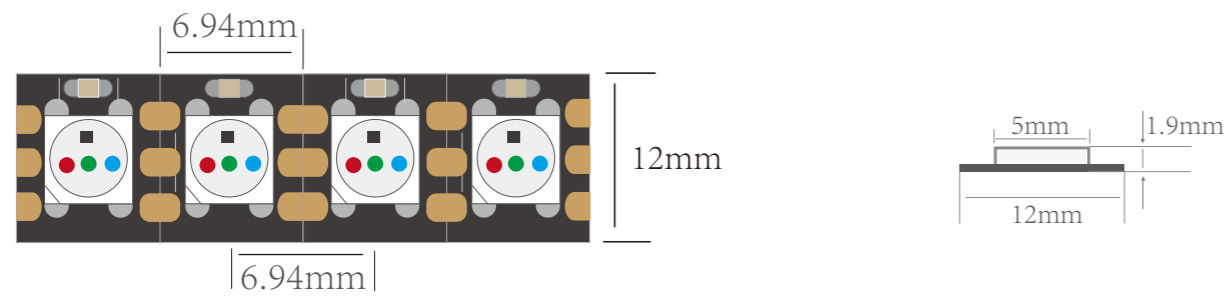

Product parameters

Product number:5V2812-144LED
 Bead type:SMD5050
 IC type:ws2812b
 Number of beads:144D/M
 Power:28.8w/m
 Voltage:5V
 IP Rating:IP20/IP65/IP67/IP68
 Cutting size:6.94mm
 Color temperature:RGB
 PCB board width:12mm
 PCB color:black/white
 Welding points:3
 Package:5M/R (customizable length)

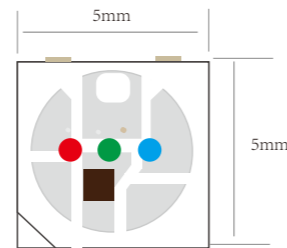

Product features

- 1.Three channel LED drive control special circuit.
- 2.144 pixels/meter, full colored beads.
- 3.Good conductivity, fast heat dissipation.
- 4.Often used for advertising signs, hotels, KTV, etc.

5V2812-60LED-RGBW

12 w/m 60 LED/M RGB W 5V 5M REEL 10 MM

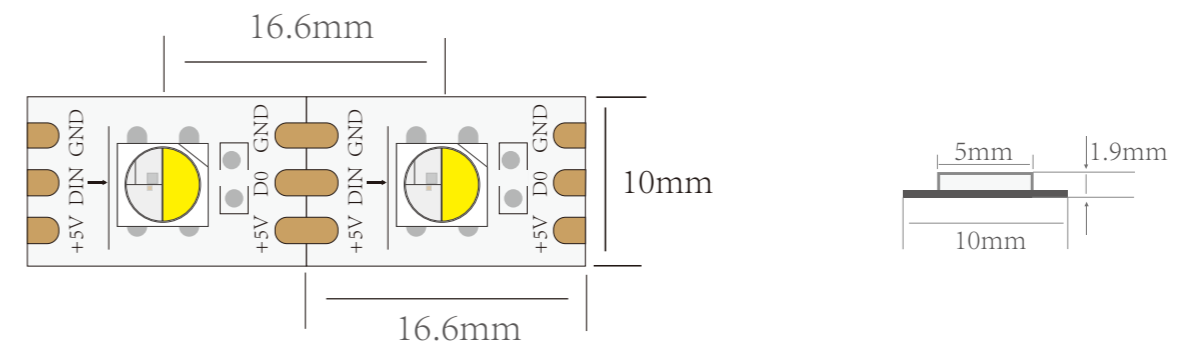

Product number:5V2812-60LED-RGBW
 Bead type:SMD5050
 IC type:ws2812b
 Number of beads:60D/M
 Power:12w/m
 Voltage:5V
 IP Rating:IP20/IP65/IP67/IP68
 Cutting size:16.6mm
 Color temperature:RGBW
 PCB board width:10mm
 PCB color:black/white
 Welding points:3
 Package:5M/R (customizable length)

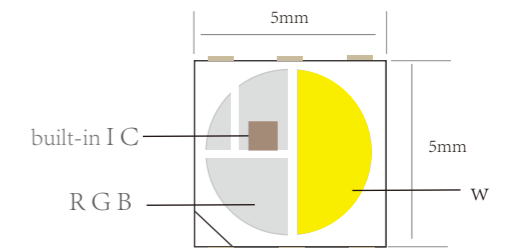

Product features

- 1.Three channel LED drive control special circuit.
- 2.60 pixels/meter, full colored beads.
- 3.RGBW four in one lamp bead.
- 4.Good conductivity, fast heat dissipation.
- 5.Often used for advertising signs, hotels, KTV, etc.

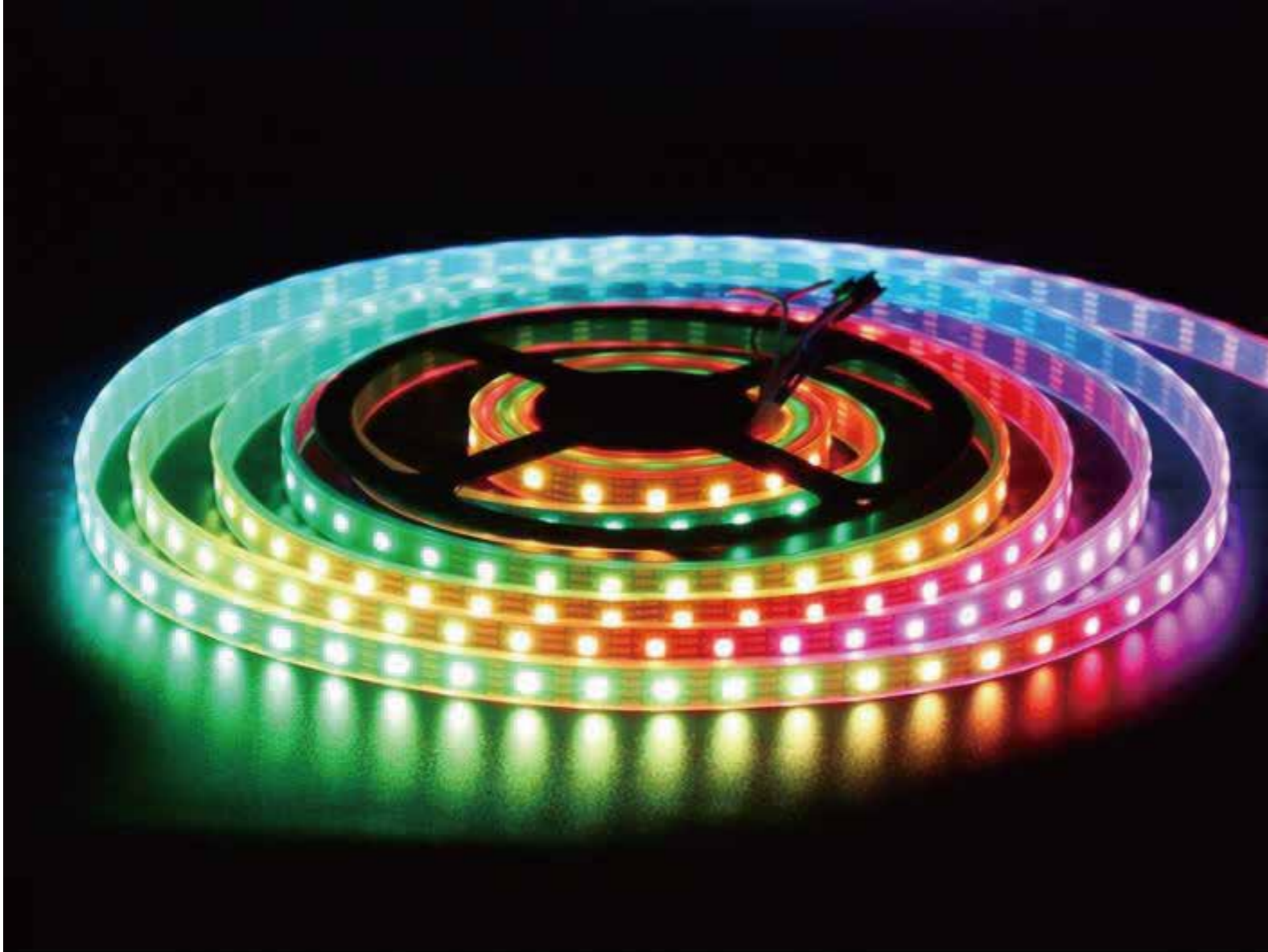

5V2813-30LED

6 w/m 30 LED/M RGB 5V 5M REEL 10 MM

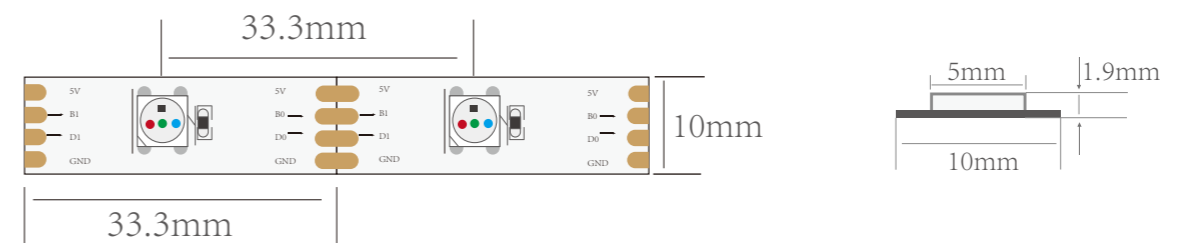

2813 SERIES



5V2813-30LED



5V2813-60LED



5V2813-144LED

Product parameters

Product number:5V2813-30LED

Bead type:SMD5050

IC type:ws2813

Number of beads:30D/M

Power:6w/m

Voltage:5V

IP Rating:IP20/IP65/IP67/IP68

Cutting size:33.3mm

Color temperature:RGB

PCB board width:10mm

PCB color:black/white

Welding points:4

Package:5M/R (customizable length)

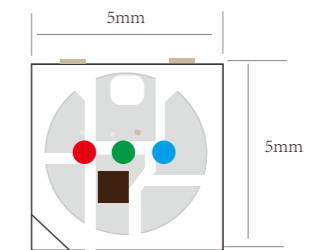

Product features

1. Parallel double signal transmission mode is adopted, which does not affect the overall color display in case of damage to a single pixel, and has the function of continuous transmission at breakpoint;
2. 30 pixels/meter;
3. good conductivity, fast heat dissipation;
4. often used for advertising signs, hotels, KTV, etc.

5V2813-60LED

12 w/m 60 LED/M RGB 5V 5M REEL 10 MM

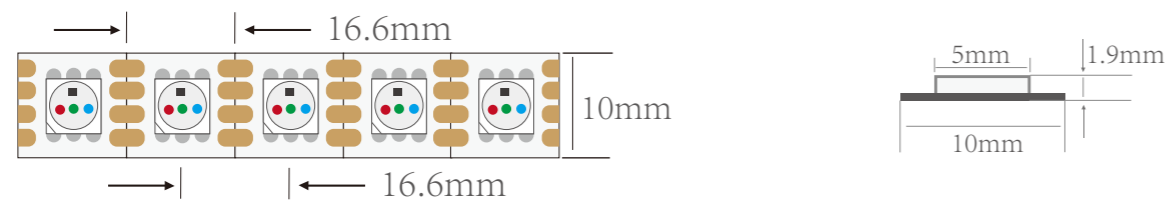

Product parameters

Product number:5V2813-60LED
 Bead type:SMD5050
 IC type:ws2813
 Number of beads:60D/M
 Power:12w/m
 Voltage:5V
 IP Rating:IP20/IP65/IP67/IP68
 Cutting size:16.6mm
 Color temperature:RGB
 PCB board width:10mm
 PCB color:black/white
 Welding points:4
 Package:5M/R (customizable length)

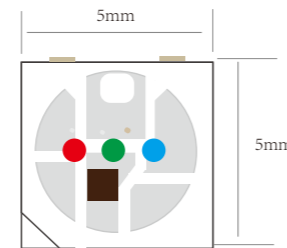

Product features

1. Parallel double signal transmission mode is adopted, which does not affect the overall color display in case of damage to a single pixel, and has the function of continuous transmission at breakpoint;
2. 60 pixels/meter;
3. good conductivity, fast heat dissipation;
4. often used for advertising signs, hotels, KTV, etc.

5V2813-144LED

28.8 w/m 144 LED/M RGB 5V 5M REEL 12 MM

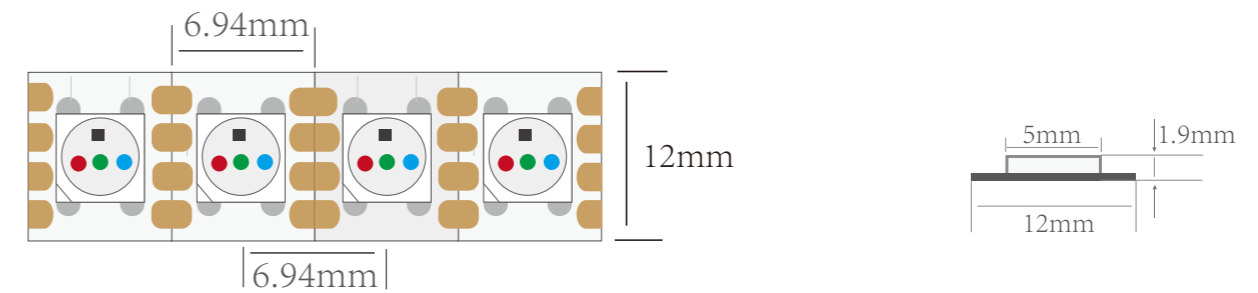

Product parameters

Product number:5V2813-144LED
 Bead type:SMD5050
 IC type:ws2813
 Number of beads:144D/M
 Power:28.8w/m
 Voltage:5V
 IP Rating:IP20/IP65/IP67/IP68
 Cutting size:6.94mm
 Color temperature:RGB
 PCB board width:12mm
 PCB color:black/white
 Welding points:4
 Package:5M/R (customizable length)

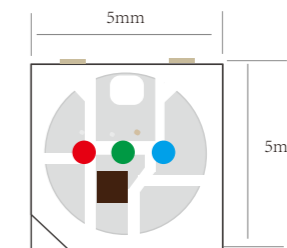

Product features

1. Parallel double signal transmission mode is adopted, which does not affect the overall color display in case of damage to a single pixel, and has the function of continuous transmission at breakpoint;
2. 144 pixels/meter;
3. good conductivity, fast heat dissipation;
4. often used for advertising signs, hotels, KTV, etc.



12V2815-30LED

6 w/m 30 LED/M RGB 12V 5M REEL 10 MM

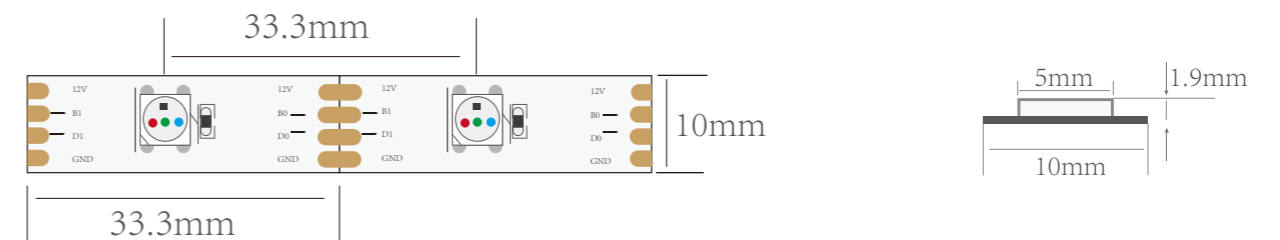

Product parameters

Product number:12V2815-30LED
 Bead type:SMD5050
 IC type:ws2815
 Number of beads:30D/M
 Power:6w/m
 Voltage:12V
 IP Rating:IP20/IP65/IP67/IP68
 Cutting size:33.3mm
 Color temperature:RGB
 PCB board width:10mm
 PCB color:black/white
 Welding points:4
 Package:5M/R (customizable length)

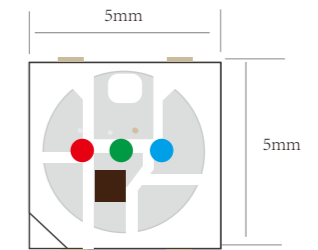

Product features

1. Parallel double signal transmission mode is adopted, which does not affect the overall color display in case of damage to a single pixel, and has the function of continuous transmission at breakpoint;
2. 30 pixels/meter;
3. good conductivity, fast heat dissipation;
4. often used for advertising signs, hotels, KTV, etc.

2815 SERIES



12V2815-30LED



12V2815-60LED



12V2815-144LED

12V2815-60LED

12 w/m 60 LED/M RGB 12V 5M REEL 10 MM

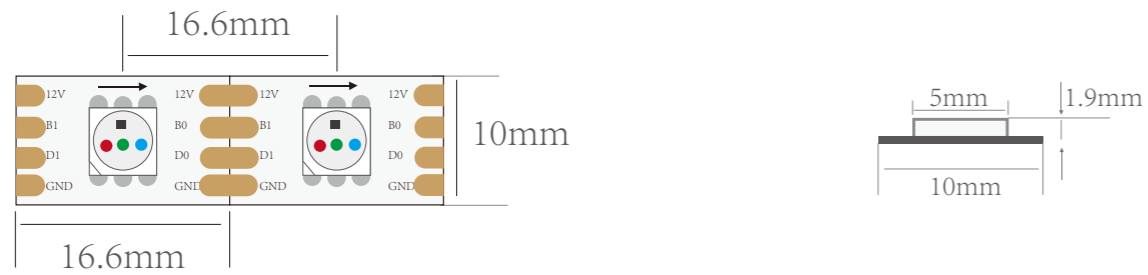

Product parameters

- Product number:12V2815-60LED
- Bead type:SMD5050
- IC type:ws2815
- Number of beads:60D/M
- Power:12w/m
- Voltage:12V
- IP Rating:IP20/IP65/IP67/IP68
- Cutting size:16.6mm
- Color temperature:RGB
- PCB board width:10mm
- PCB color:black/white
- Welding points:4
- Package:5M/R (customizable length)

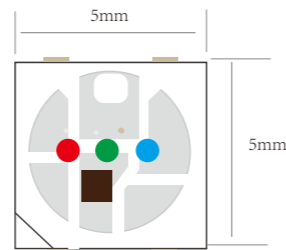

Product features

1. Parallel double signal transmission mode is adopted, which does not affect the overall color display in case of damage to a single pixel, and has the function of continuous transmission at breakpoint;
2. 60 pixels/meter;
3. good conductivity, fast heat dissipation;
4. often used for advertising signs, hotels, KTV, etc.

12V2815-144LED

28.8 w/m 144 LED/M RGB 12V 5M REEL 10 MM

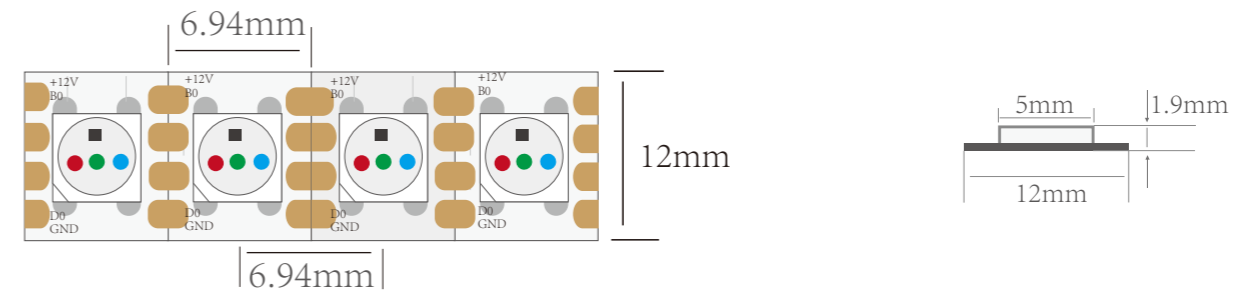

Product parameters

- Product number:12V2815-144LED
- Bead type:SMD5050
- IC type:ws2815
- Number of beads:144D/M
- Power:28.8w/m
- Voltage:12V
- IP Rating:IP20/IP65/IP67/IP68
- Cutting size:6.94mm
- Color temperature:RGB
- PCB board width:12mm
- PCB color:black/white
- Welding points:4
- Package:5M/R (customizable length)

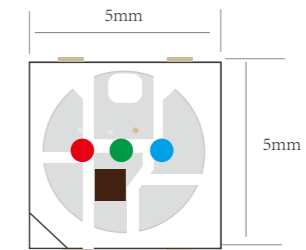

Product features

1. Parallel double signal transmission mode is adopted, which does not affect the overall color display in case of damage to a single pixel, and has the function of continuous transmission at breakpoint;
2. 144 pixels/meter;
3. good conductivity, fast heat dissipation;
4. often used for advertising signs, hotels, KTV, etc.



12V2818-30LED

6 w/m 30 LED/M RGB 12V 5M REEL 10 MM

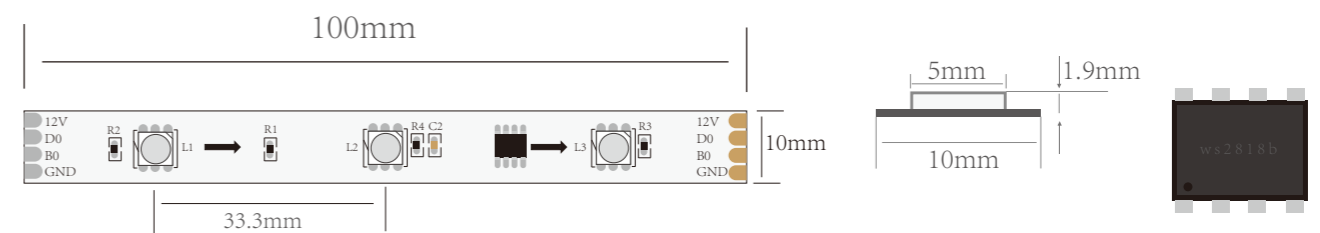

2818 SERIES

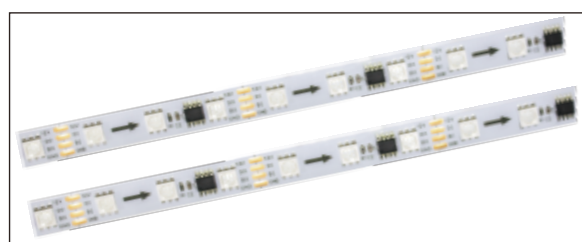

12V2818-30LED



12V2818-60LED-white light



12V2818-60LED

Product parameters

Product number:12V2818-30LED

Bead type:SMD5050

IC type:ws2818

Number of beads:30D/M

Power:6w/m

Voltage:12V

IP Rating:IP20/IP65/IP67/IP68

Cutting size:100mm

Color temperature:RGB

PCB board width:10mm

PCB color:black/white

Welding points:4

Package:5M/R (customizable length)

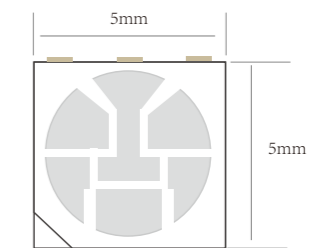

Product features

1. RGB light, with IC control program;
2. with breakpoint continuation function;
3. 10 pixels/meter;
4. good conductivity, fast heat dissipation;
5. often used for advertising signs, hotels, KTV, etc.

12V2818-60LED

12 w/m 60 LED/M RGB 12V 5M REEL 10 MM

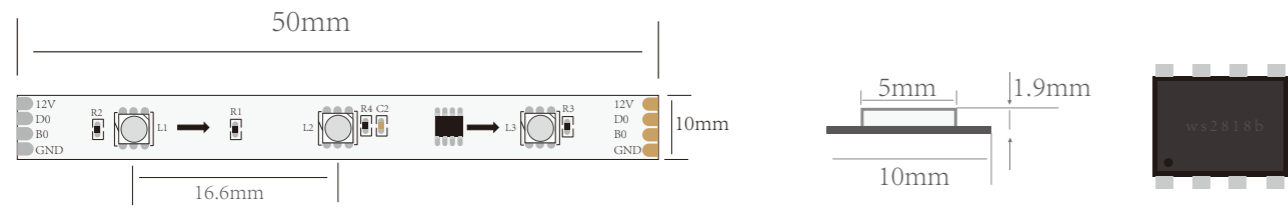

Product parameters

- Product number:12V2818-60LED
- Bead type:SMD5050
- IC type:ws2818
- Number of beads:60D/M
- Power:12w/m
- Voltage:12V
- IP Rating:IP20/IP65/IP67/IP68
- Cutting size:50mm
- Color temperature:RGB
- PCB board width:10mm
- PCB color:black/white
- Welding points:4
- Package:5M/R (customizable length)

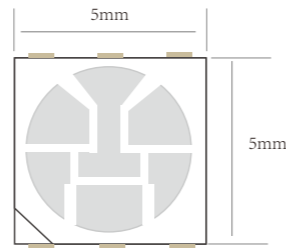

Product features

1. RGB light, with IC control program;
2. with breakpoint continuation function;
3. 20 pixels/meter;
4. good conductivity, fast heat dissipation;
5. often used for advertising signs, hotels, KTV, etc.

12V2818-60LED-white light

12 w/m 60 LED/M RGB 12V 5M REEL 10 MM

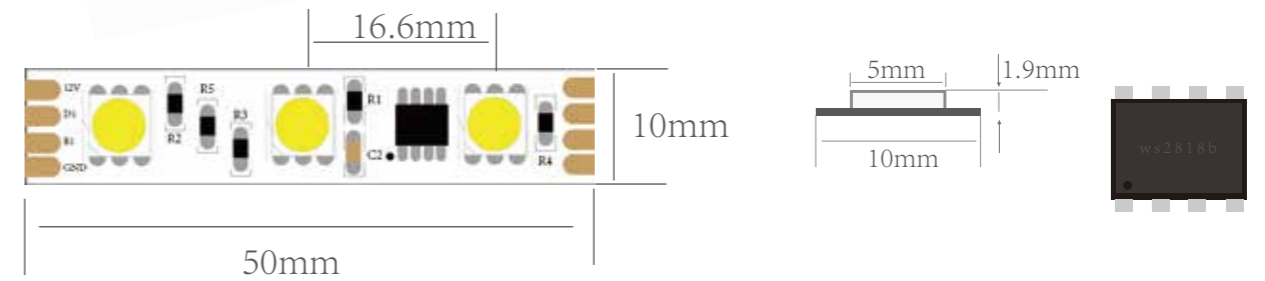

Product parameters

- Product number:12V2818-60LED
- Bead type:SMD5050
- IC type:ws2818
- Number of beads:60D/M
- Power:12w/m
- Voltage:12V
- IP Rating:IP20/IP65/IP67/IP68
- Cutting size:50mm
- Color temperature:W
- PCB board width:10mm
- PCB color:black/white
- Welding points:4
- Package:5M/R (customizable length)

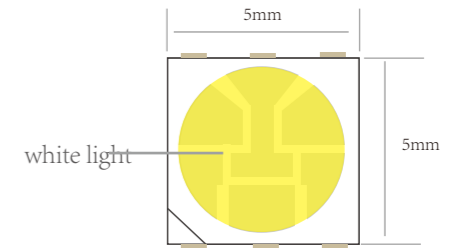

Product features

1. white light, with IC control program;
2. with breakpoint continuation function;
3. 20 pixels/meter;
4. good conductivity, fast heat dissipation;
5. often used for advertising signs, hotels, KTV, etc.



2020 SERIES



5V2020-120LED

5V2020-120LED

24 w/m 120 LED/M RGB 5V 5M REEL 4 MM

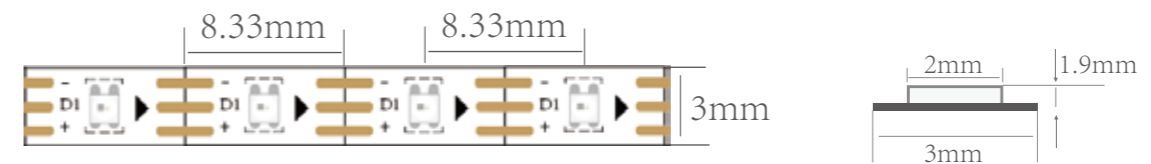

Product parameters

Product number:5V2020-120LED

Bead type:SMD2020

IC type:ws2812b

Number of beads:120D/M

Power:24w/m

Voltage:5V

IP Rating:IP20/IP65/IP67/IP68

Cutting size:8.33mm

Color temperature:W

PCB board width:3mm

PCB color:black/white

Welding points:3

Package:5M/R (customizable length)

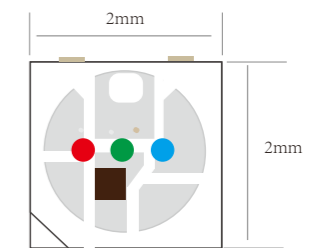

Product features

- 1.board width 4mm compatible with all kinds of small space, installation, electronic products supporting;
- 2.120 pixels/meter, full color lamp beads, lamp beads dense, luminous effect;
- 3.good conductivity, fast heat dissipation;
- 4.often used for advertising signs, hotels, KTV, etc.



SEVEN COLOR RGB LIGHT STRIP SERIES

- Dimming, multiple waterproof types are optional, easy to operate, can be cut, can be connected.
- Soft, easy to bend, make a variety of graphics text.
- With RGBW four in one with a variety of types of luminous effect, to achieve a single product with a variety of colors.
- Can be used in a variety of different occasions to meet different needs;
Such as: home environment, large shopping malls, bars, roads,

七彩RGB灯带列表

产品编号	输入电压 (V)	最大功率 (w/m)	显指	色温/颜色	每米灯珠	最小剪裁	板宽 (mm)	长度 (m/R)	防护工艺	图示
RGB灯带系列										
24V3838RGB-120灯	24V	14.4	/	RGB	60	50mm	8mm	5	IP20 IP65 IP67 IP68	
12V5050RGB-60灯	12V	12	/	RGB	60	50mm	10mm	5	IP20 IP65 IP67 IP68	
24V5050RGB-60灯	24V	12	/	RGB	60	100mm	10mm	5	IP20 IP65 IP67 IP68	
RGBW灯带系列										
24V5050-RGBWW-60灯	24V	21.6	>80	RGB+ 2700k+ 6500k	60	100mm	12mm	5	IP20 IP65 IP67 IP68	
24V5050-RGBW-96灯	24V	24	>80	RGB+ 6500k	96	62.5mm	12mm	5	IP20 IP65 IP67 IP68	
24V5050-RGBW-60灯	24V	12	>80	RGB+ 6500k	60	100mm	12mm	5	IP20 IP65 IP67 IP68	
24V3838RGB+2835W-192灯	24V	12	>80	RGB+ 6500k	192	62.5mm	12mm	5	IP20 IP65 IP67 IP68	

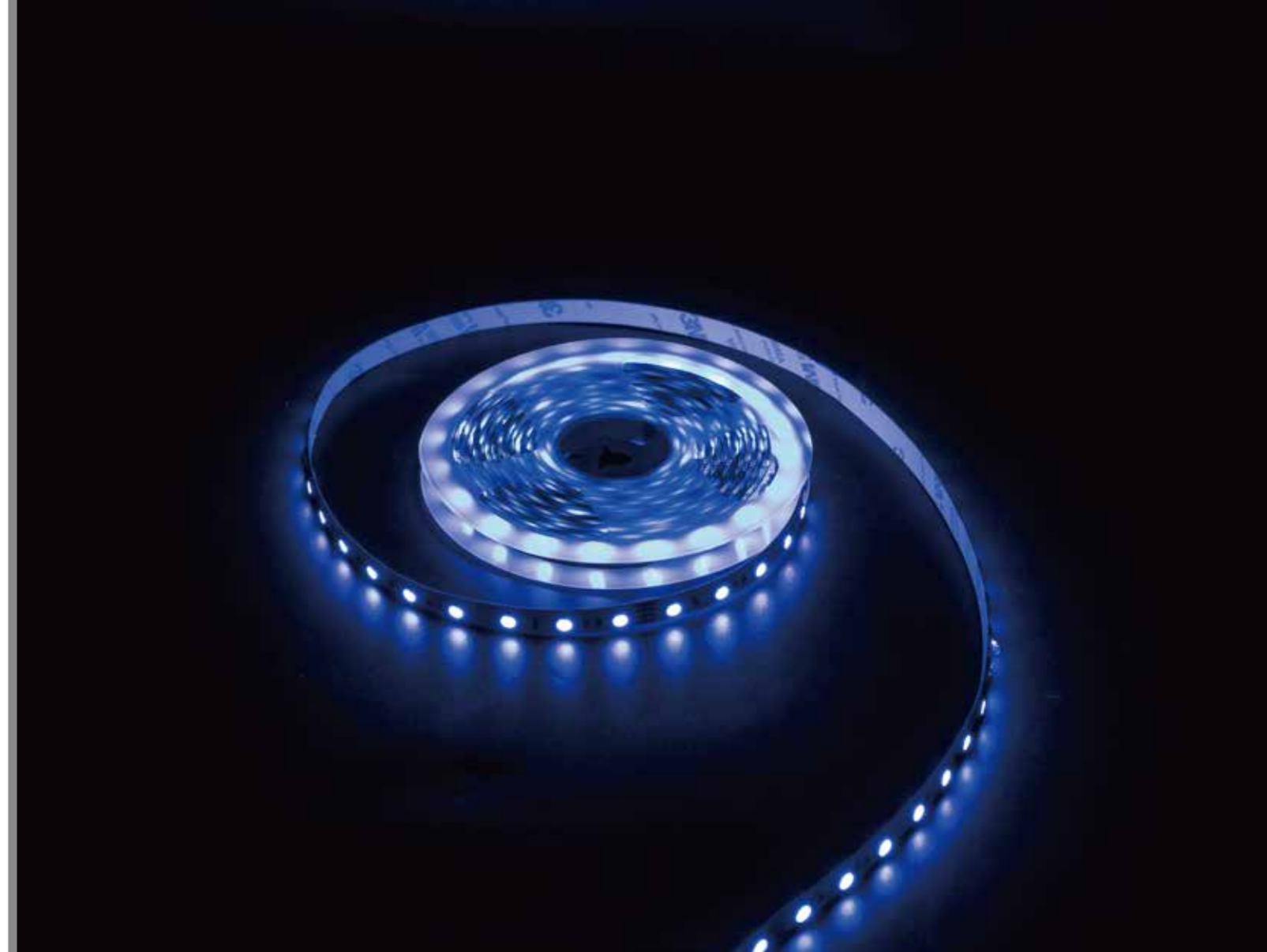
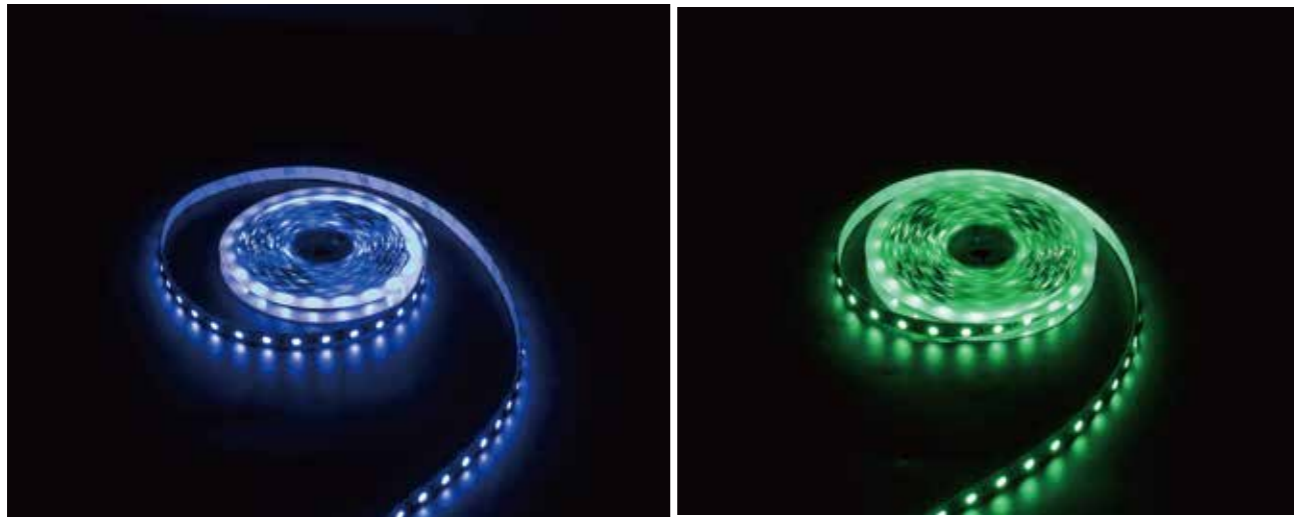

RGB SERIES



24V3838RGB-120LED



24V5050RGB-60LED



12V5050RGB-60LED

24V3838RGB-120LED

14.4 w/m 120 LED/M RGB 12V 5M REEL 8 MM

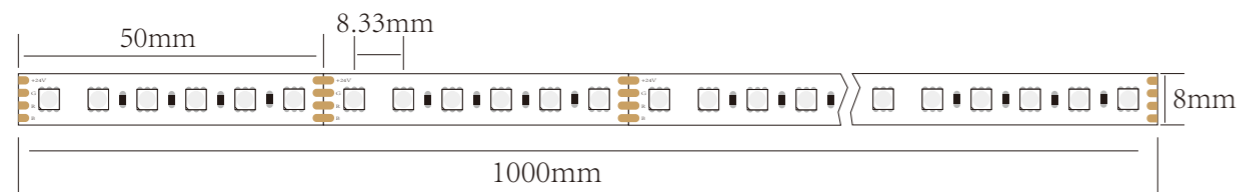

Product parameters

Product number:24V3838RGB-120LED

Bead type:SMD3838

Number of beads:120D/M

Power:14.4w/m

Voltage:24V

IP Rating:IP20/IP65/IP67/IP68

Cutting size:50mm

Color temperature:RGB

PCB board width:8mm

PCB color:white

Package:5M/R (customizable length)

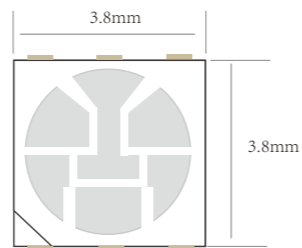

Product features

1. 3838 lamp beads, red green blue alone light, can also be combined light into a variety of colors;
2. green environmental protection lighting source
3. can be bent at will, can be fixed on the convex and concave surface;
4. compact size, rich color; .

12V5050RGB-60LED

12 w/m 60 LED/M RGB 12V 5M REEL 10 MM

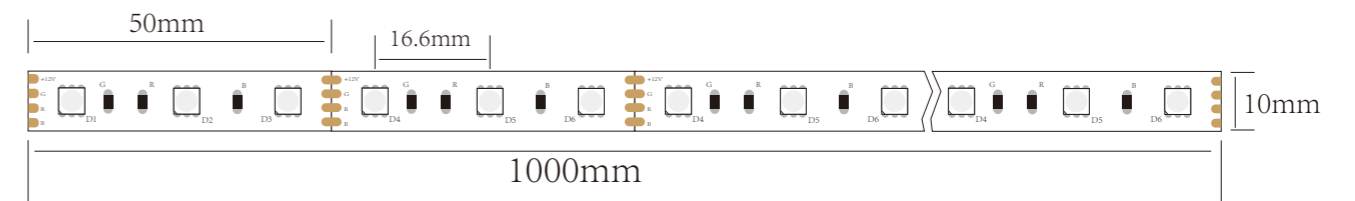

Product parameters

Product number:12V5050RGB-60LED

Bead type:SMD5050

Number of beads:60D/M

Power:12w/m

Voltage:12V

IP Rating:IP20/IP65/IP67/IP68

Cutting size:50mm

Color temperature:RGB

PCB board width:10mm

PCB color:white

Package:5M/R (customizable length)

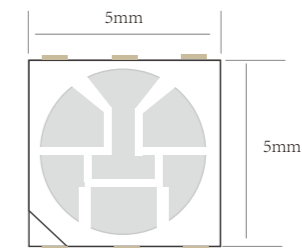

Product features

1. 5050 lamp beads,;
2. a single product can achieve a variety of colors including white light;
3. can be bent at will, can be fixed on the convex and concave surface;

24V5050RGB-60LED

12 w/m 60 LED/M RGB 24V 5M REEL 10 MM

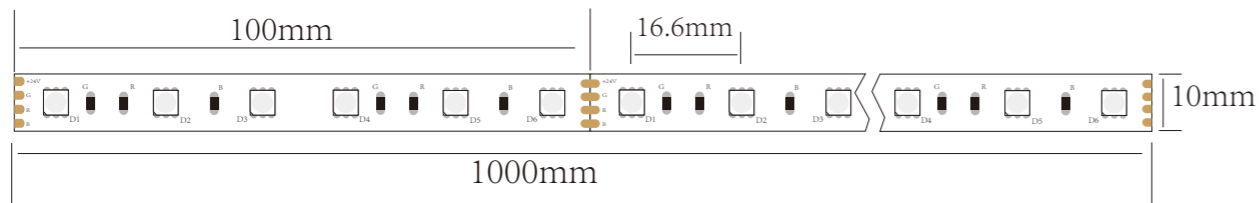

Product parameters

Product number:24V5050RGB-60LED
 Bead type:SMD5050
 Number of beads:60D/M
 Power:12w/m
 Voltage:24V
 IP Rating:IP20/IP65/IP67/IP68
 Cutting size:100mm
 Color temperature:RGB
 PCB board width:10mm
 PCB color:white
 Package:5M/R (customizable length)

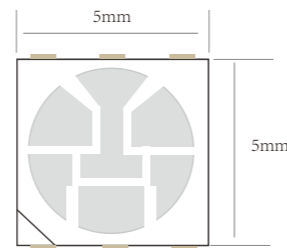

Product features

1. 5050 lamp beads,;
2. a single product can achieve a variety of colors including white light;
3. can be bent at will, can be fixed on the convex and concave surface;

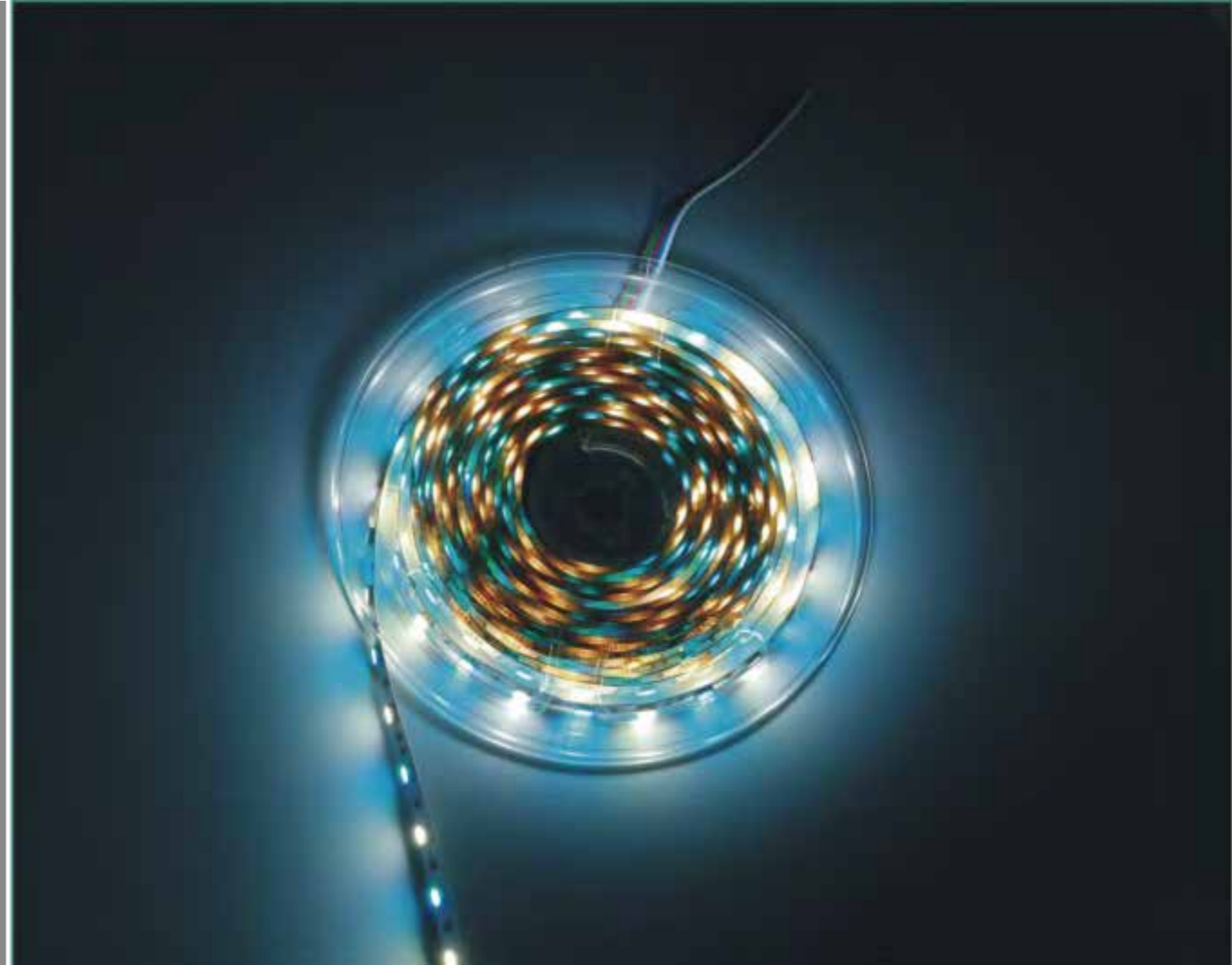

RGBW SERIES



24V5050-RGBWW-60LED



24V5050-RGBW-60LED



24V5050-RGBW-96LED



24V3838RGB+2835W-192LED

24V5050-RGBWW-60LED

21.6 w/m 60 LED/M RGBWW 24V 5M REEL 12 MM

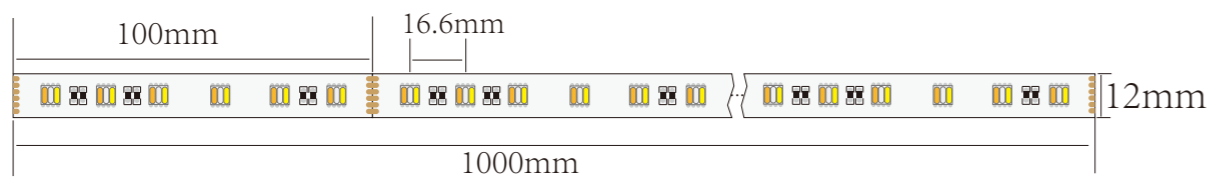

Product parameters

Product number:24V5050-RGBWW-60LED

Bead type:SMD5050

Number of beads:60D/M

Power:21.6w/m

Voltage:24V

CRI:>80

IP Rating:IP20/IP65/IP67/IP68

Cutting size:100mm

Color temperature:RGB+2700k+6500k

PCB board width:12mm

PCB color:white

Package:5M/R (customizable length)

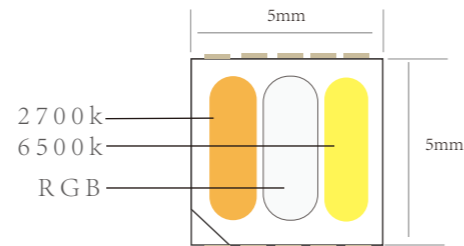

Product features

1. 5050 lamp beads, great brightness.
2. RGBWW five-in-one lamp beads, a single product can achieve a variety of colors including three kinds of white light.
3. suitable for a variety of occasions.

24V5050-RGBW-96LED

24 w/m 96 LED/M RGBW 24V 5M REEL 12 MM

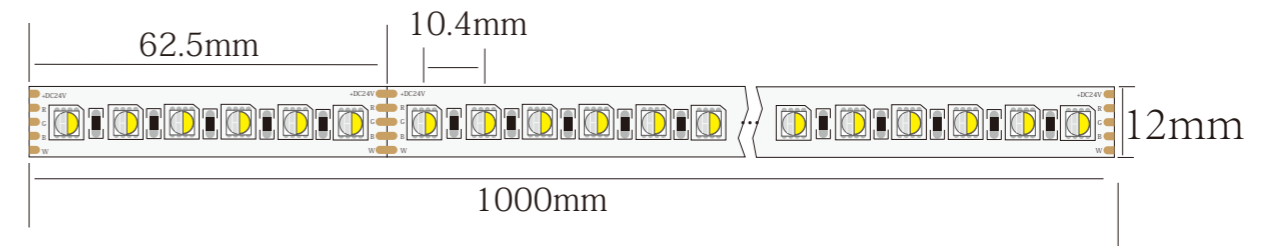

Product parameters

Product number:24V5050-RGBW-96LED

Bead type:SMD5050

Number of beads:96D/M

Power:21.6w/m

Voltage:24V

CRI:>80

IP Rating:IP20/IP65/IP67/IP68

Cutting size:62.5mm

Color temperature:RGB+6500k

PCB board width:12mm

PCB color:white

Package:5M/R (customizable length)

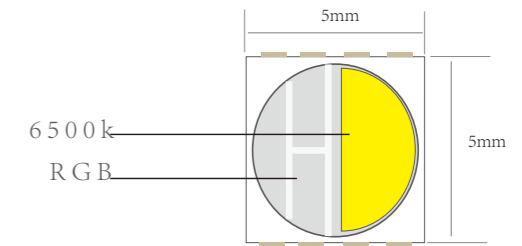

Product features

1. 5050 lamp beads, great brightness.
2. RGBW four-in-one lamp beads, a single product can achieve a variety of colors including three kinds of white light.
3. suitable for a variety of occasions.

24V5050-RGBW-60LED

12 w/m 60 LED/M RGBW 24V 5M REEL 12 MM

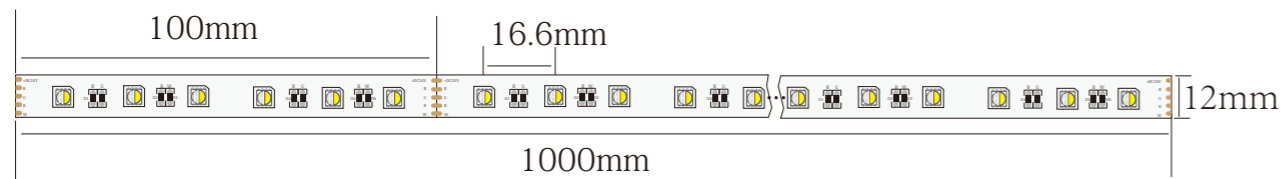

Product parameters

Product number:24V5050-RGBW-60LED

Bead type:SMD5050

Number of beads:60D/M

Power:12w/m

Voltage:24V

CRI:>80

IP Rating:IP20/IP65/IP67/IP68

Cutting size:100mm

Color temperature:RGB+6500k

PCB board width:12mm

PCB color:white

Package:5M/R (customizable length)

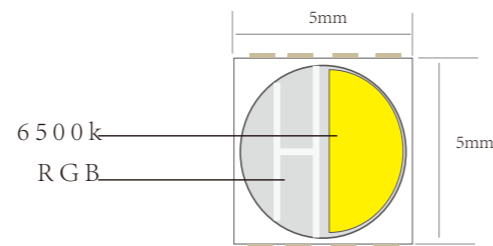

Product features

1. 5050 lamp beads, great brightness.
2. RGBW four-in-one lamp beads, a single product can achieve a variety of colors including three kinds of white light.
3. suitable for a variety of occasions.

24V3838RGB+2835W-192LED

12 w/m 192 LED/M RGB+W 24V 5M REEL 12 MM

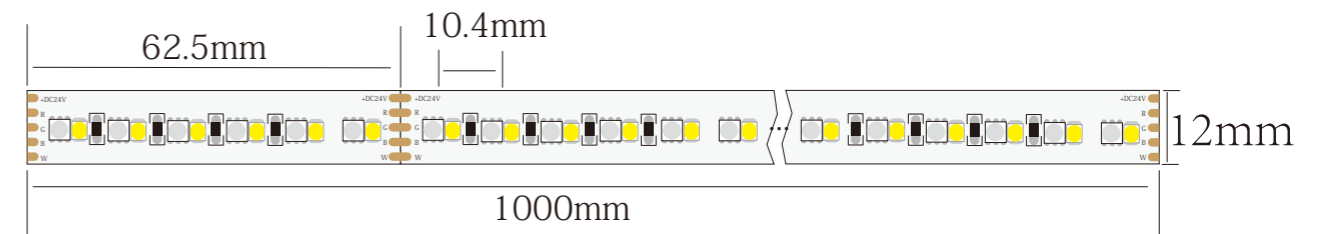

Product parameters

Product number:24V3838RGB+2835W-192LED

Bead type:3838+2538

Number of beads:192D/M

Power:12w/m

Voltage:24V

CRI:>80

IP Rating:IP20/IP65/IP67/IP68

Cutting size:62.5mm

Color temperature:RGB+6500k

PCB board width:12mm

PCB color:white

Package:5M/R (customizable length)

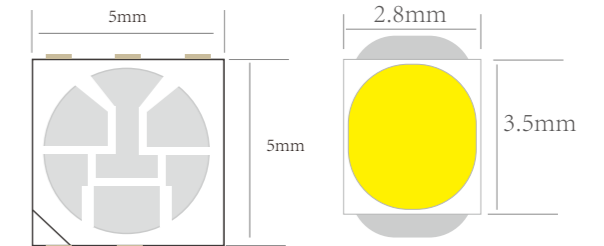

Product features

- 1.5050 lamp beads, great brightness.
- 2.RGB+W two kinds of lamp beads, a single product can achieve a variety of colors including three kinds of white light.
- 3.suitable for a variety of occasions.



NEON LED STRIP SERIES

Silicone neon strip is made of two-color silicone integrated extrusion forming process, the protection grade reaches IP67/IP68, with salt resistance, acid and alkali, gas corrosion, fire resistance, UV resistance characteristics; Can be widely used in indoor and outdoor modeling design, corridor, eaves corners and other places, play a decorative lighting effect.

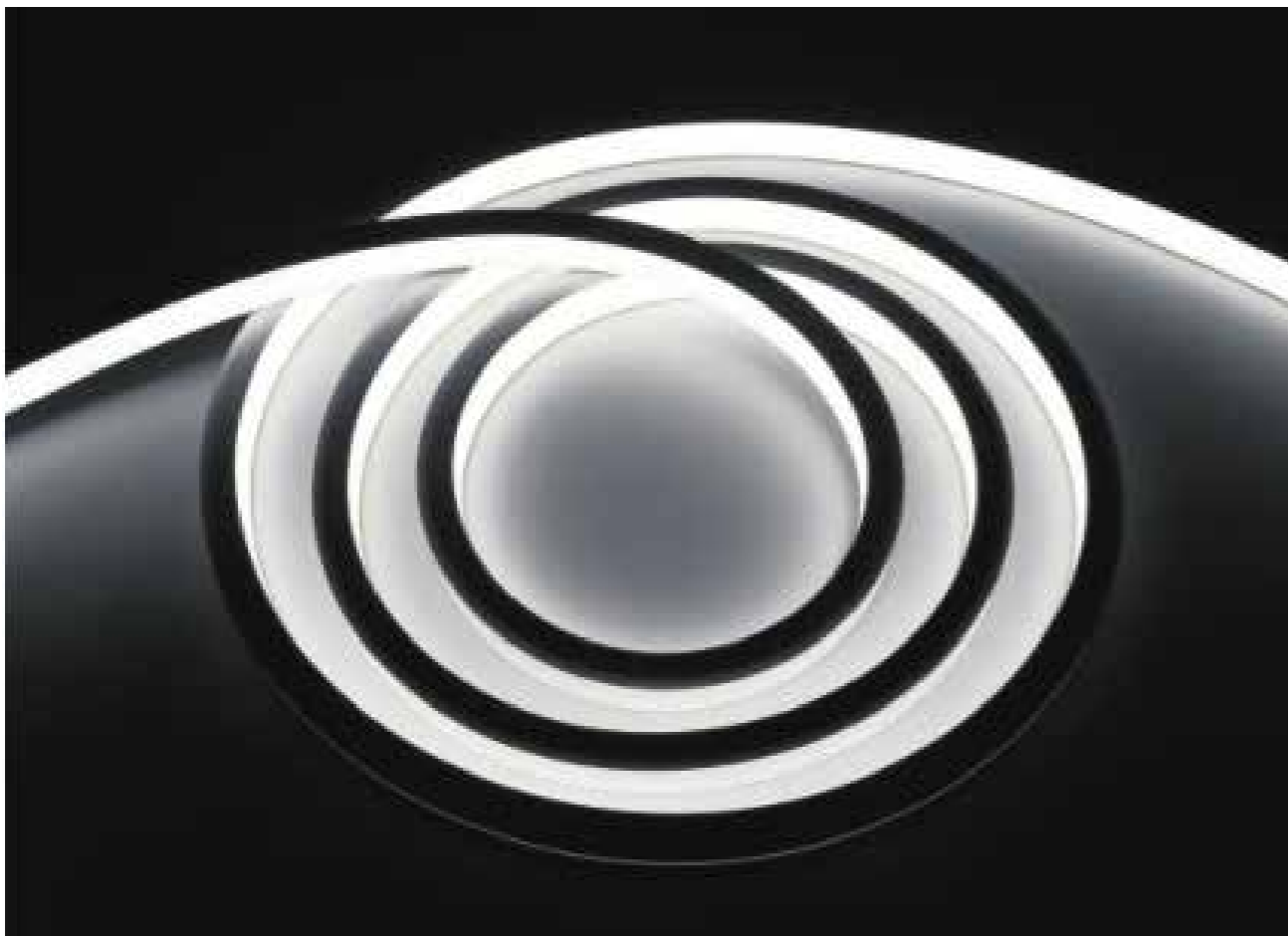
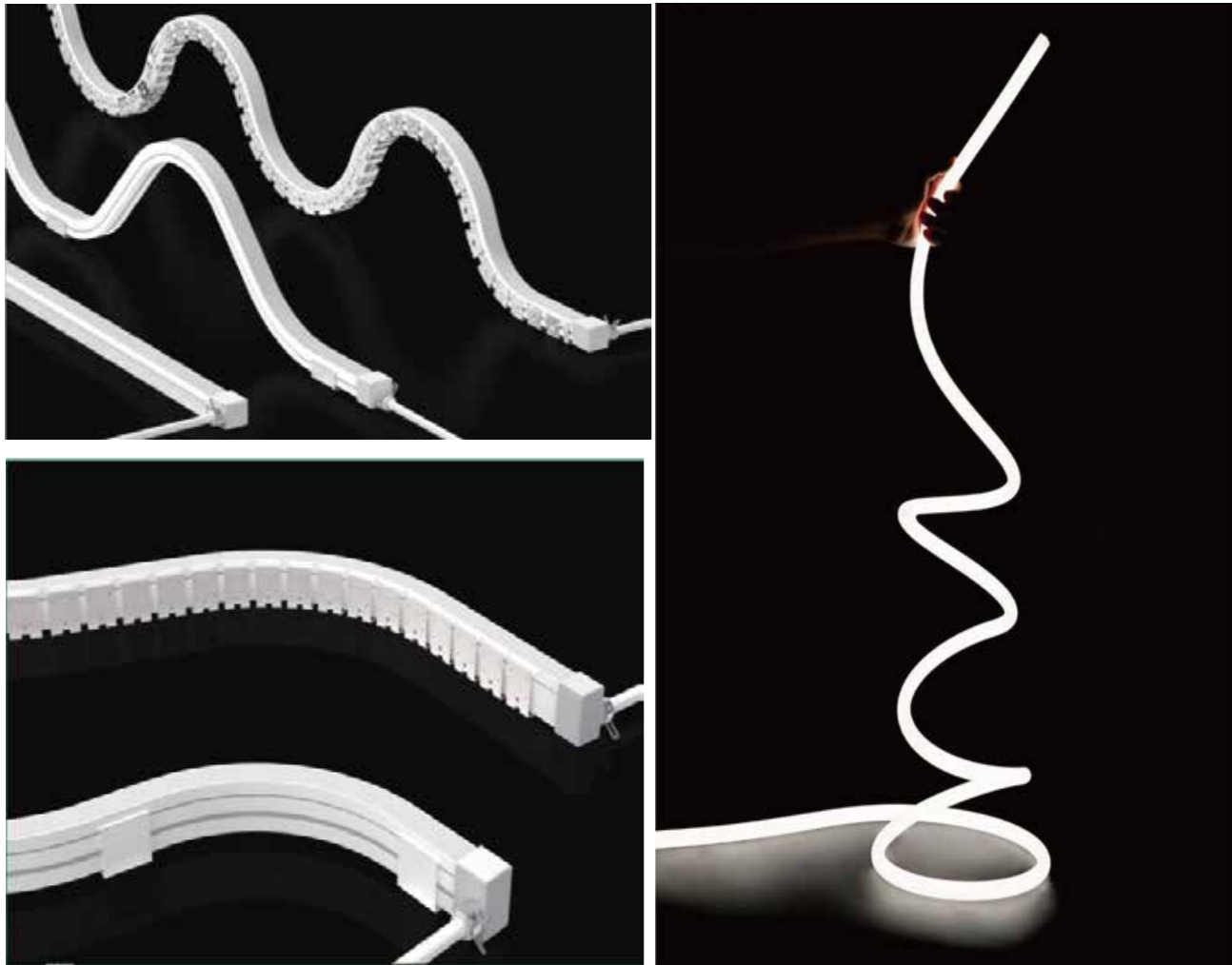

Neon Light Solution

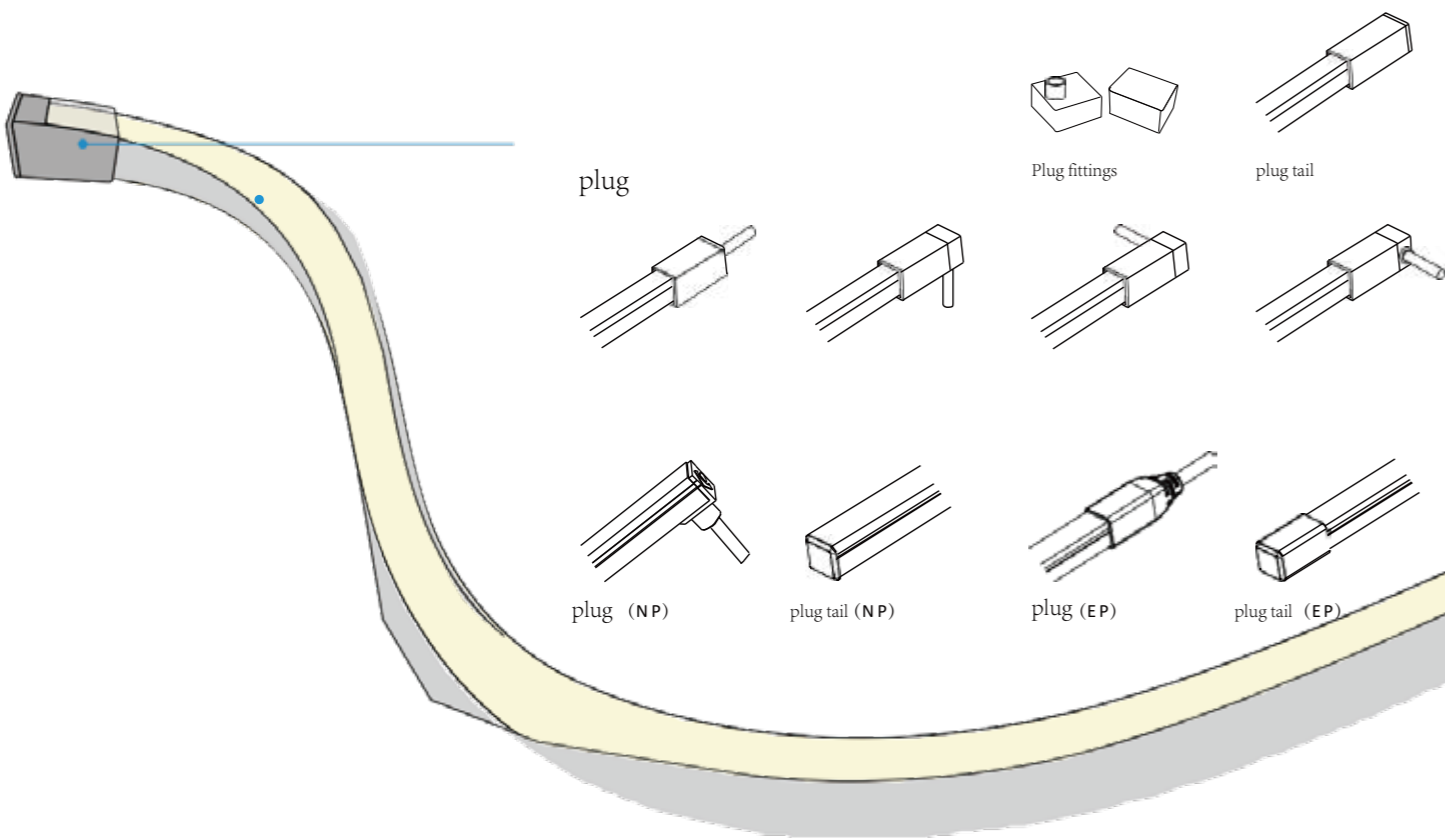
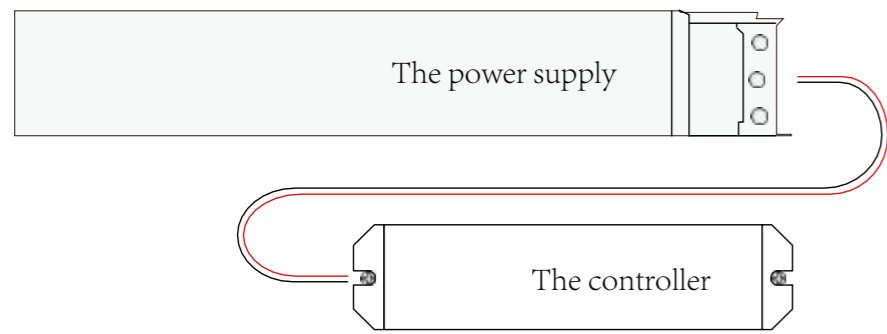

Clipping line

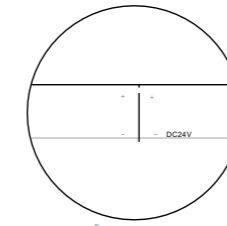

Connection accessories

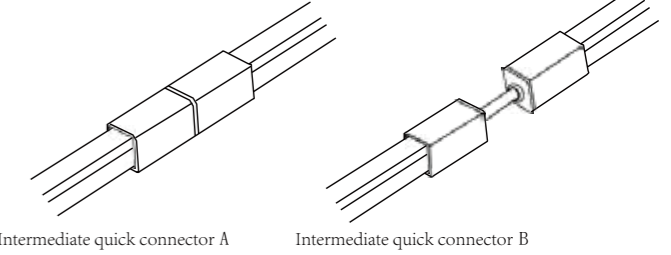

The installation accessories

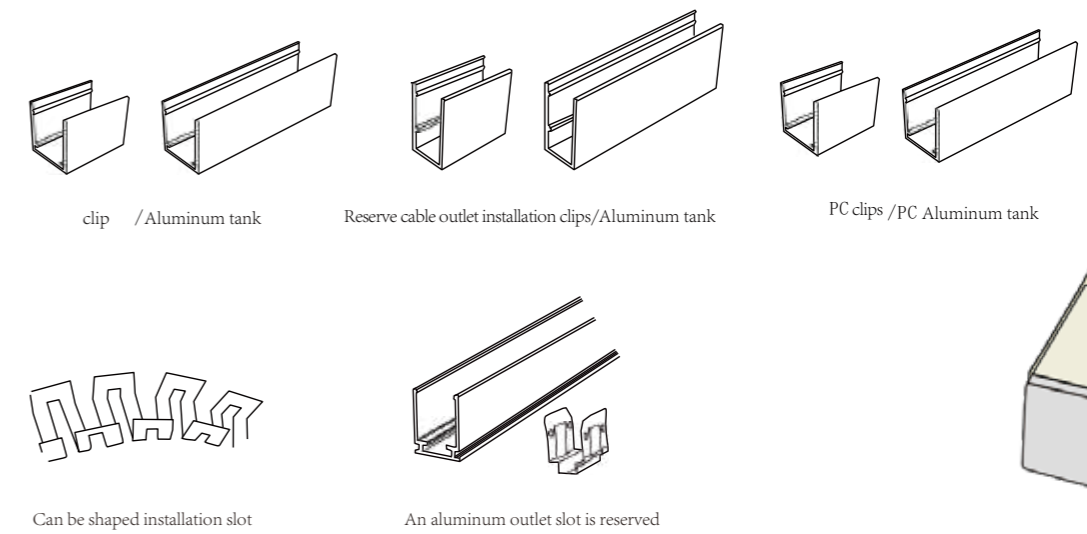

Lamp bead

Ra/CRI > 80/90



packaging

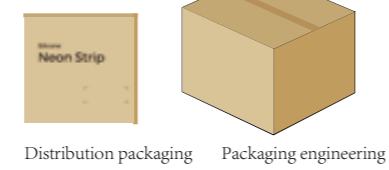

wire & glue

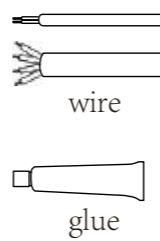

Protection technology

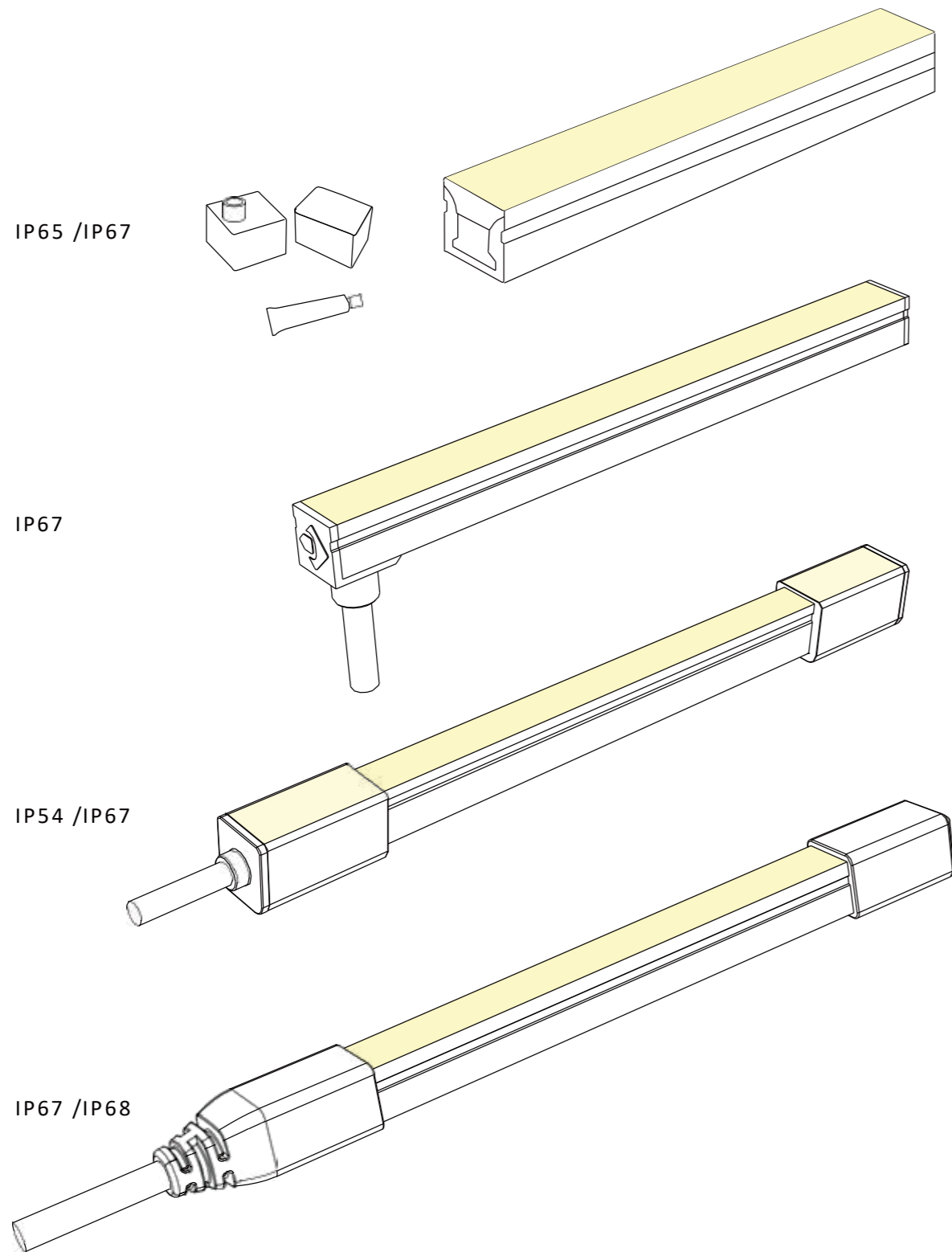

IP67 Welding free quick joint

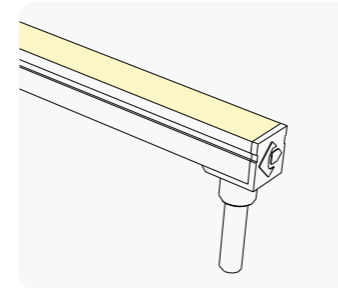

Quick connector (No wire)

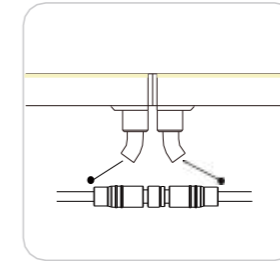

Quick connector (No wire)

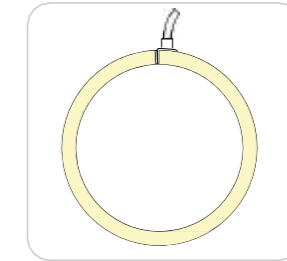

The inward curve of the lights interconnects
No dark space



IP67 Welding free quick joint

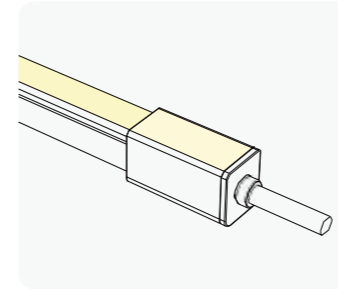

Quick connector (No wire)

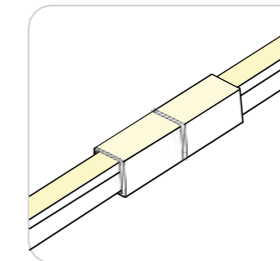

Quick connector (No wire)

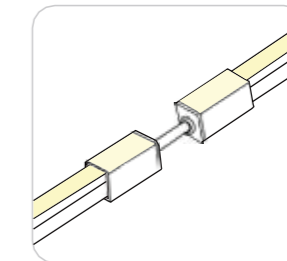

Deconstructed drawing of weld-free interconnect accessories

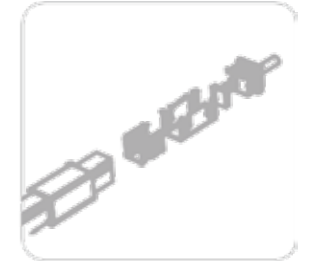

IP68 Can be used at the bottom of swimming pools

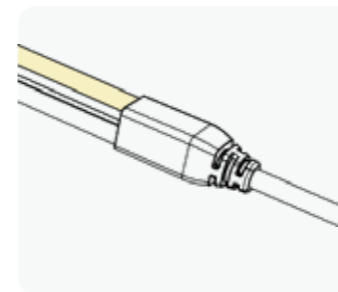

The swimming pool

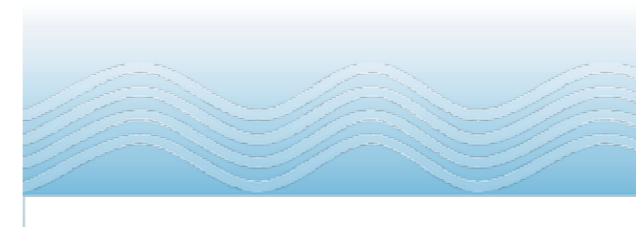

Neon light installation scheme

1、 Install card buckle

Install the buckle in the desired position



2、 tailoring

Cut from the black mark

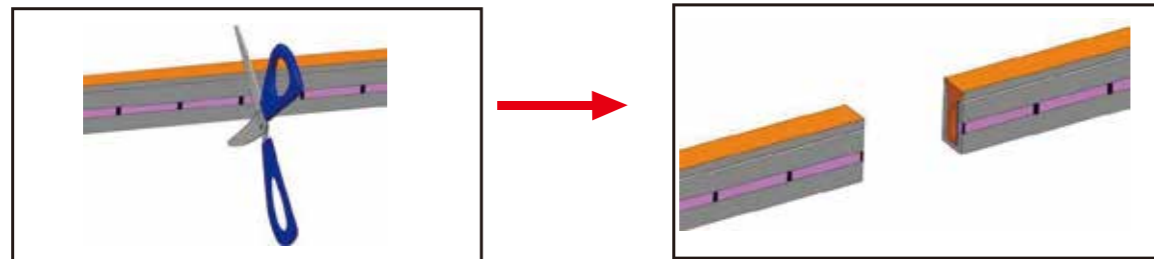

3、 Welding line

Thread the power cable of a size less than or equal to the outlet plug in the direction of the arrow. Weld the power cable to the PCB with the red positive terminal and black negative terminal

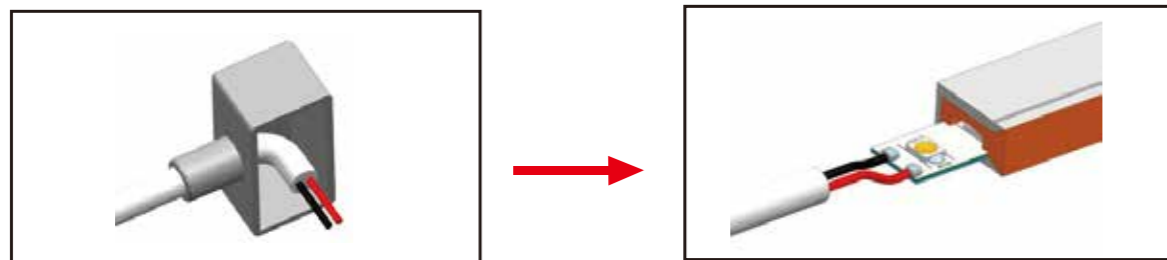

4、 Install the plug

(1) Apply glue around the indicator tape plug, and insert the indicator tape into the plug. Wipe the excess glue from the plug and cable outlet.

(2) Glue the tail plug (non-outlet plug) on the other end of the lamp belt in the same way.

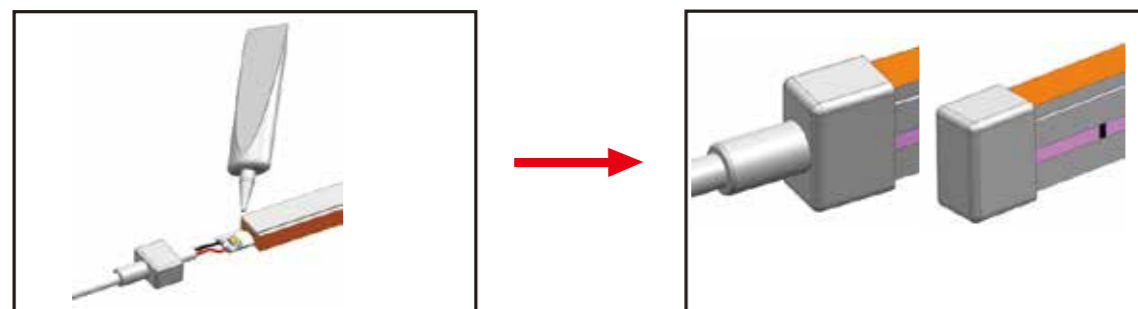

5、 After the plug is installed, the table should be left to dry for 15-20 minutes before it can be moved and cured for 24 hours

6、 Install the light belt only after the glue on the plug is cured

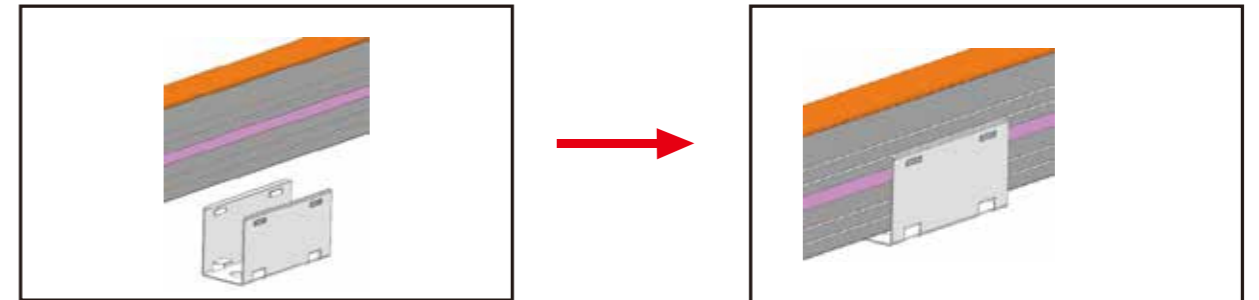

Classification of neon light strip

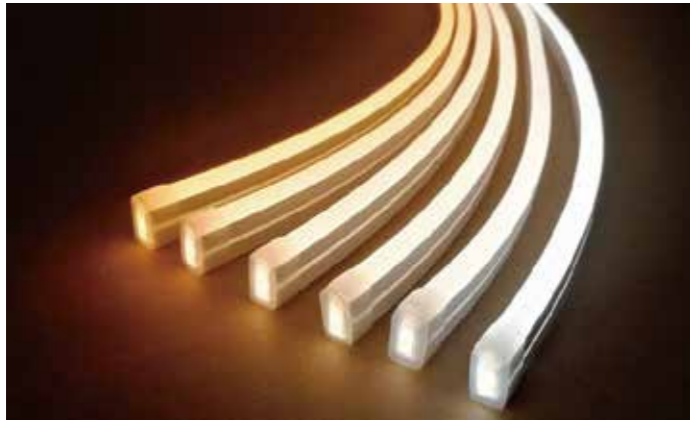

Front light series

1. front light, suitable for a variety of width lamp belt;
2. environmental protection silica gel material, plasticity, waterproof effect is excellent;
3. low energy consumption, hydrochloric acid resistance, acid and alkali corrosion resistance;
4. dynamic strong, good effect, diverse colors, economic and practical;
5. high light transmittance, can be used for indoor and outdoor decoration, improve the city aesthetic feeling, make the citizens feel the charm of the city.



Side luminescent series

1. environmental protection silica gel material, plasticity;
2. low energy consumption, long life;
3. dynamic, good effect, economic and practical;
4. side light, side bending;
5. Decorate parks and street lights at night to enhance the beauty of the city, make the citizens feel the charm of the city.

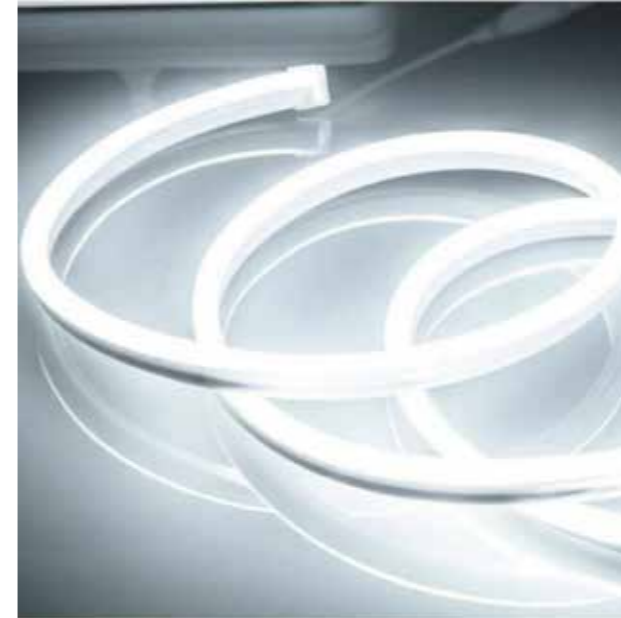

Three side luminescence series











1. three sides of light, suitable for a variety of width lamp belt;
2. environmental protection silica gel material, plasticity, waterproof effect is excellent;
3. low energy consumption, hydrochloric acid resistance, acid and alkali corrosion resistance;
4. dynamic strong, good effect, diverse colors, economic and practical;
5. high light transmittance, can be used for indoor and outdoor decoration, improve the city aesthetic feeling, make the citizens feel the charm of the city.



360° full luminescence series

1. low temperature, use is not restricted by climate;
2. low energy consumption, long life;
3. innovative technology, 360 degrees of comprehensive light, no dark area dead Angle;
4. soft material, with system application solutions, to meet the needs of any modeling;
5. Decorate parks and street lights at night to enhance the aesthetic feeling of the city and make citizens feel the charm of the city.

Neon Strip List

Product model	section size	luminescence direction	applicable plate width	lamp number	diagram
DZ-10*10 (mm)	10*10	Front light	5/6mm	120LED/M	
DZ-10*10 (mm)	10*10	Three side luminescence	5/6mm	120LED/M	
DZ-30*20 (mm)	30*20	Front light	12/15mm	60-120LED/M	
DZ-30*20 (mm)	30*20	Front light	15mm	60-120LED/M	
DZ-16*16 (mm)	16*16	Three side luminescence	12mm	60-120LED/M	
DZ-16*16 (mm)	16*16	Front light	12mm	60-120LED/M	
SC-6*12 (mm)	6*12	Side luminescent	8mm	120LED/M	
SC-10*20 (mm)	10*20	Side luminescent	10mm	60-120LED/M	
DQ-∅22(mm)360°	∅22mm	360° Full luminescent	5/6mm	60-120LED/M	
DQ-∅22(mm)360°	∅22mm	360° Full luminescent	5/6mm	60-120LED/M	
DZ-12*12 (mm)	12*12	Front light	8mm	60-120LED/M	
DC-12*12 (mm)	12*12	Side luminescent	5mm	60-120LED/M	

Product model	section size	luminescence direction	applicable plate width	lamp number	diagram
DC-12*20 (mm)	12*20	Front light	10/12mm	60-120LED/M	
DC-12*20 (mm)	12*20	Three side luminescence	10mm	60-120LED/M	
DZ-14*20 (mm)	14*20	Front light	10/12mm	60-120LED/M	
DZ-14*20 (mm)	14*20	Three side luminescence	10/12mm	60-120LED/M	
DZ-17*25 (mm)	17*25	Front light	12mm	60-120LED/M	
DZ-27*20 (mm)	27*20	Front light	12/15mm	60-120LED/M	
DZ-20*20 (mm)	20*20	Three side luminescence	10/12mm	60-120LED/M	
DZ-20*20 (mm)	20*20	Front light	10/12mm	60-120LED/M	
DZ-15*25 (mm)	15*25	Three side luminescence	10mm	60-120LED/M	
DZ-20*16 (mm)	20*16	Three side luminescence	10mm	60-120LED/M	
SC-6*16(mm)	6*16	Side luminescent	8mm	60-120LED/M	
DZ-8*16 (mm)	8*16	Three side luminescence	10/12mm	60-120LED/M	

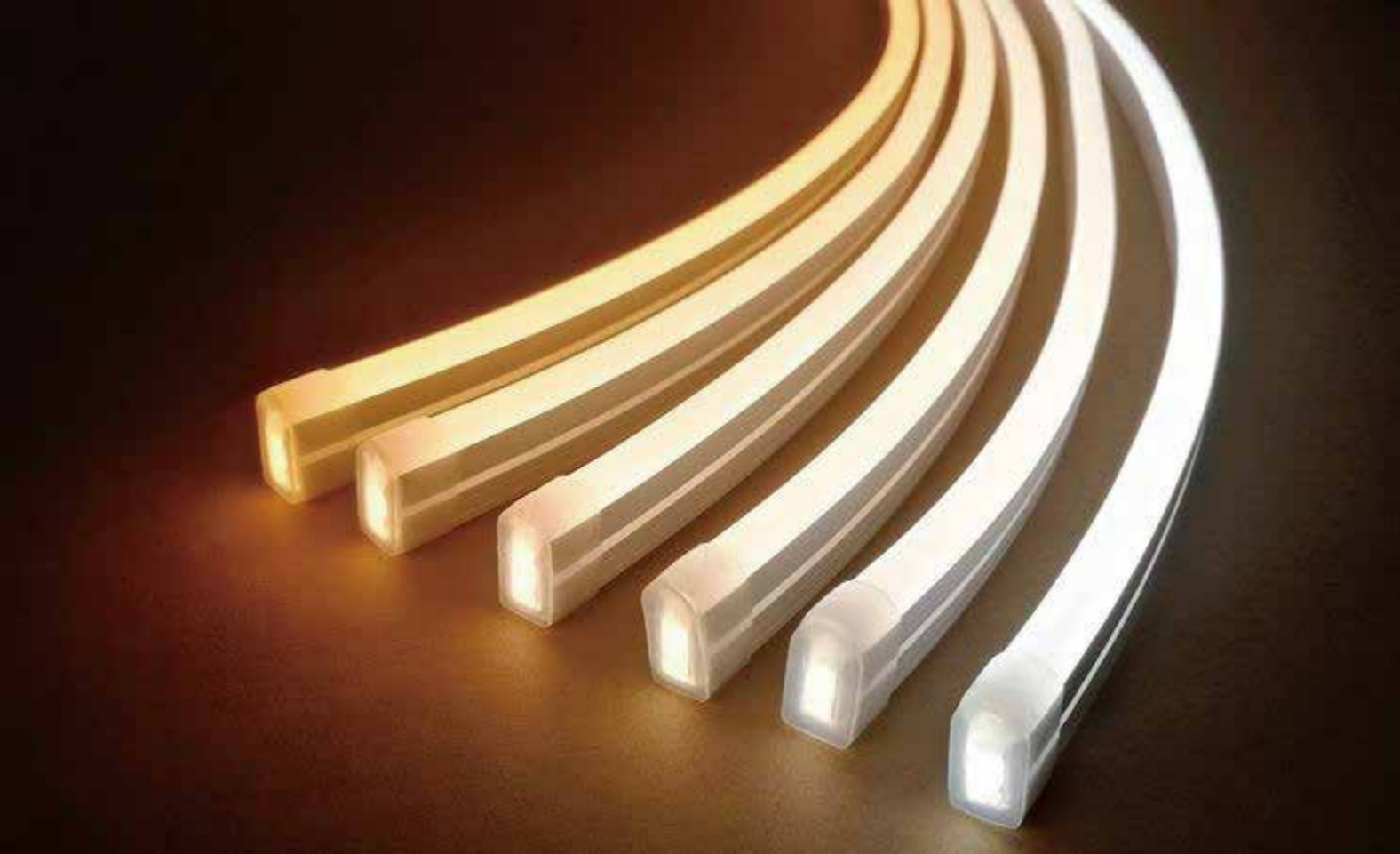

DZ- 10*10 (mm)

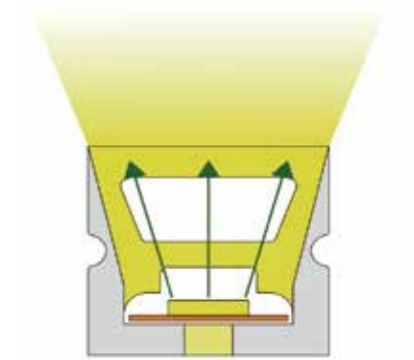
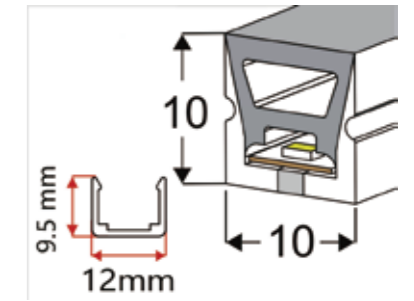
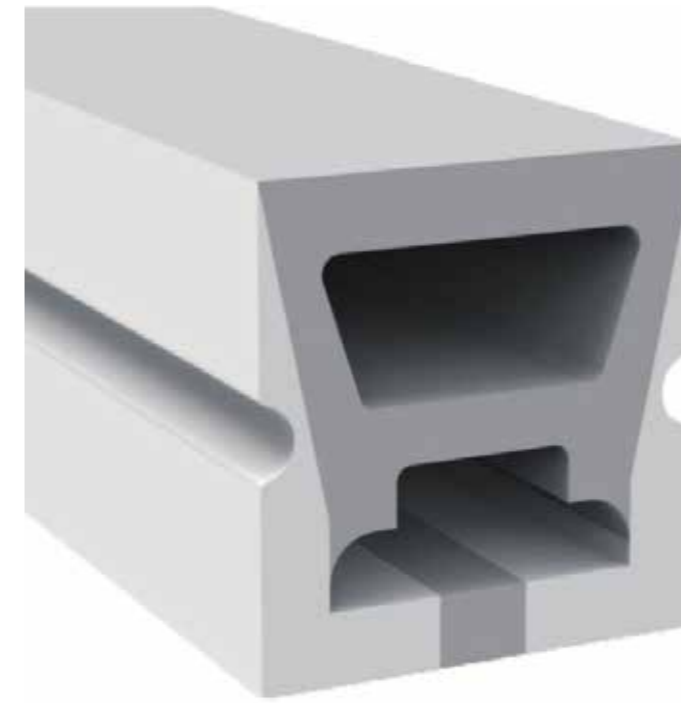

FRONT LIGHT SERIES

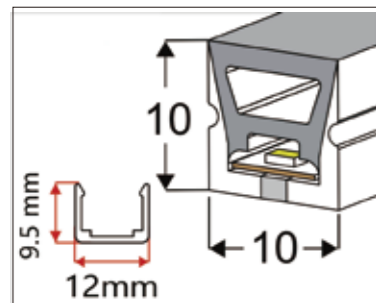

DZ- 10*10 (mm)

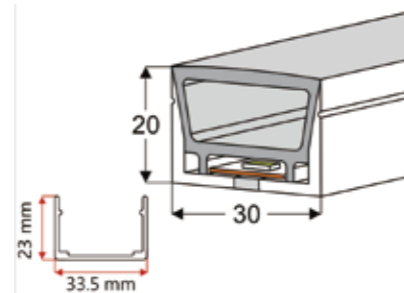

DZ- 20*30 (mm)

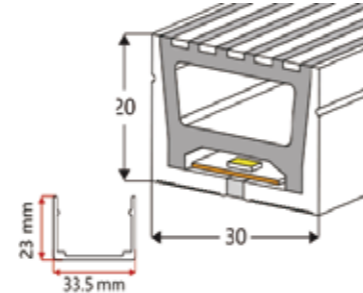

DZ- 20*30 (mm)

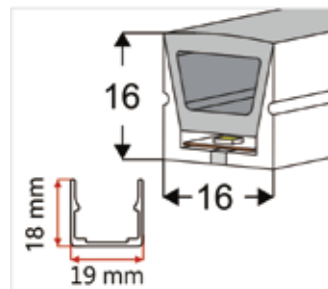

DZ- 16*16 (mm)

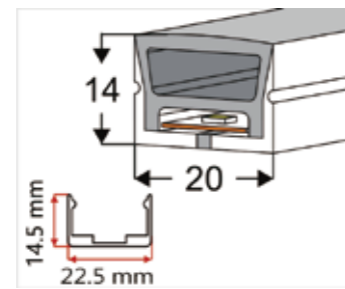

DZ- 14*20 (mm)

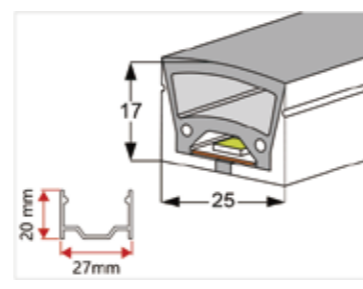

DZ- 17*25 (mm)

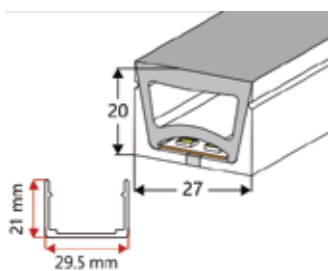

DZ- 20*27 (mm)

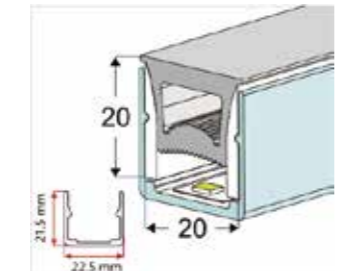

DZ- 20*20 (mm)

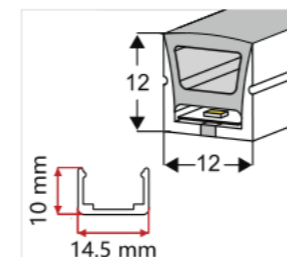

DZ- 12*12 (mm)

Product parameters

Product Number: DZ-10 *10 (mm)

Section size: 10*10

Light direction: Front light

Waterproof grade: IP67

Weight: 110 g/m

Length: Length can be customized

Applicable plate width: 5/6mm

Number of lamp beads: 120leds/m

Available lamp beads: equal size lamp beads universal

Accessories

name	specifications	graphic
plug	quantity:1	
plug tail	quantity:1	
clip	L:25mm+screw	
Aluminium	L:1000mm+screw	
Bendable aluminum profile	L:1000mm+screw	
glue	10ml	

Product features

1. Front light, suitable for 5/6mm wide lamp belt;
2. Environmental protection silica gel material, plasticity;
3. Low energy consumption, hydrochloric acid resistance, acid and alkali corrosion resistance;
4. Dynamic strong, good effect, economic and practical;
5. High light transmittance, can be used for indoor and outdoor decoration.





DZ- 30*20 (mm)



Product parameters

Product Number: DZ-30*20 (mm)
 Section size: 30*20
 Light direction: Front light
 Waterproof grade: IP67
 Weight: 395 g/m
 Length: Length can be customized
 Applicable plate width: 15mm
 Number of lamp beads: 120leds/m
 Available lamp beads: equal size lamp beads universal

Accessories

name	specifications	graphic
plug	quantity:1	
plug tail	quantity:1	
clip	L:25mm+screw	
Aluminium	L:1000mm+screw	
glue	10ml	

Product features

1. Low temperature, use is not restricted by climate.
2. Low energy consumption, long life.
3. Dynamic strong, good effect, economic and practical.
4. Decorate parks and street lights at night to enhance the beauty of the city, make the citizens feel the charm of the city.



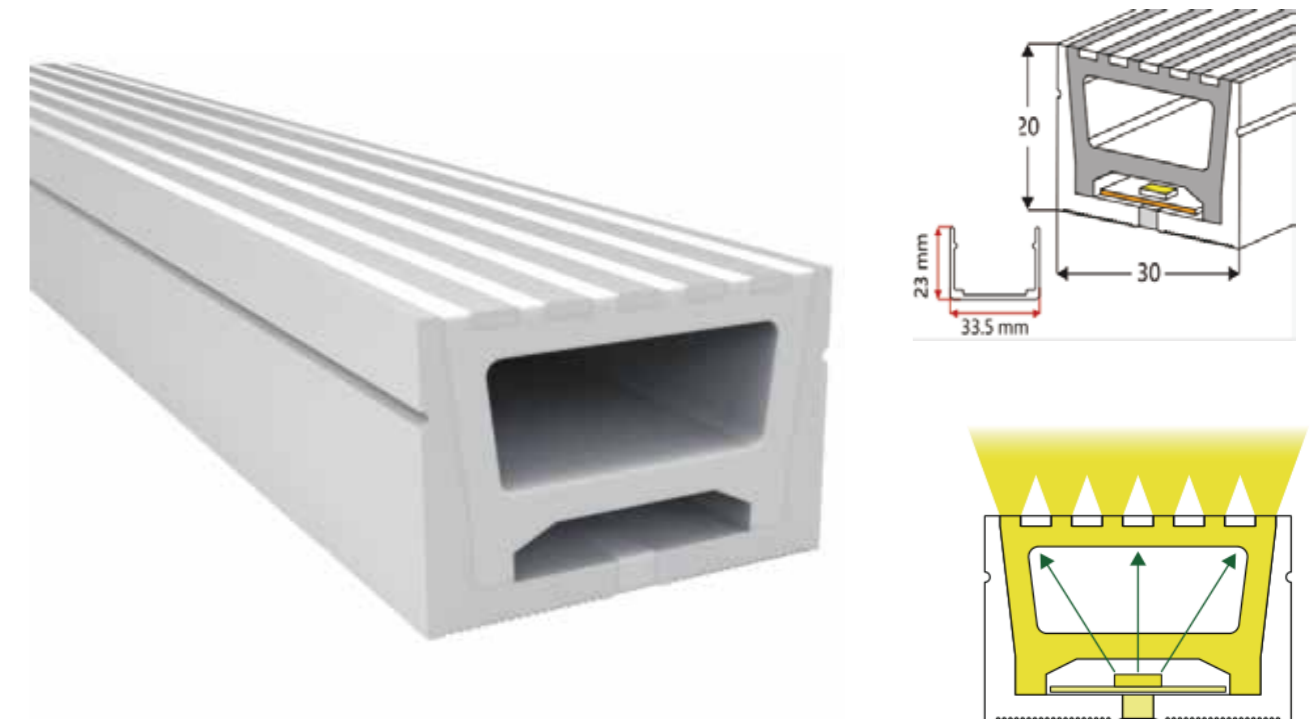

DZ- 30*20 (mm)



Product parameters

Product Number: DZ-30*20 (mm)
 Section size: 30*20
 Light direction: Front light
 Waterproof grade: IP67
 Weight: 455 g/m
 Length: Length can be customized
 Applicable plate width: 12/15mm
 Number of lamp beads: 60-120leds/m
 Available lamp beads: equal size lamp beads universal

Accessories

name	specifications	graphic
plug	quantity:1	
plug tail	quantity:1	
clip	L:25mm+screw	
Aluminium	L:1000mm+screw	
glue	10ml	

Product features

1. Low temperature, use is not restricted by climate.
2. Low energy consumption, long life.
3. Dynamic strong, good effect, economic and practical.
4. Decorate parks and street lights at night to enhance the beauty of the city, make the citizens feel the charm of the city.





DZ- 16*16 (mm)



Product parameters

Product Number: DZ-16.16 (mm)
 Section size: 16*16
 Light direction: Front light
 Waterproof grade: IP67
 Weight: 185 g/m
 Length: Length can be customized
 Applicable plate width: 12mm
 Number of lamp beads: 60-120leds/m
 Available lamp beads: equal size lamp beads universal

Accessories

name	specifications	graphic
plug	quantity:1	
plug tail	quantity:1	
clip	L:25mm+screw	
Aluminium	L:1000mm+screw	
Bendable aluminum profile	L:1000mm+screw	
glue	10ml	

Product features

1. Environmental protection silica gel material, plasticity;
2. Low energy consumption, hydrochloric acid resistance, acid and alkali corrosion resistance;
3. Dynamic strong, good effect, economic and practical
- 4.High light transmittance, can be used for indoor and outdoor decoration, improve the city aesthetic feeling,make the citizens feel the charm of the city.



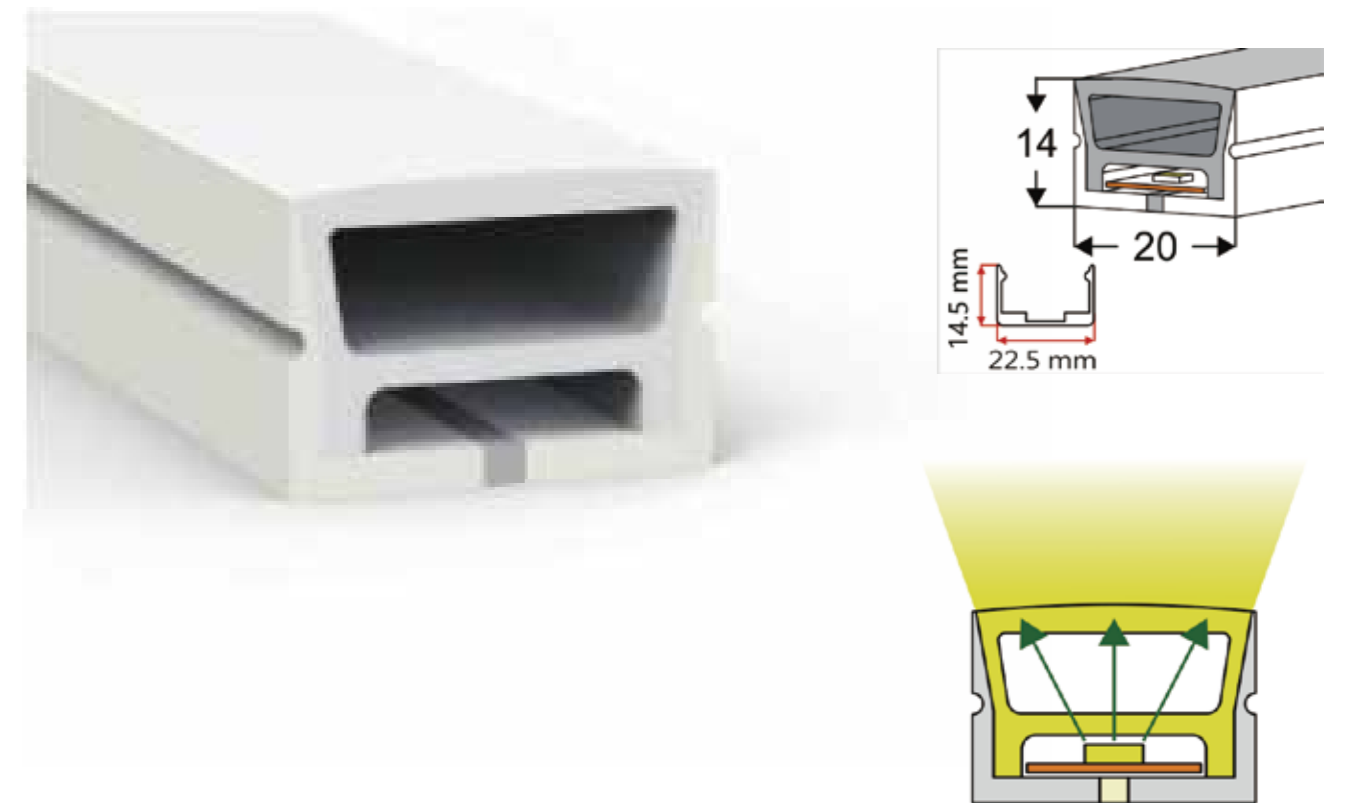

DZ- 14*20 (mm)



Product parameters

Product Number: DZ-14*20 (mm)
 Section size: 14*20
 Light direction: Front light
 Waterproof grade: IP67
 Weight: 198 g/m
 Length: Length can be customized
 Applicable plate width: 10/12mm
 Number of lamp beads: 60-120leds/m
 Available lamp beads: equal size lamp beads universal

Accessories

name	specifications	graphic
plug	quantity:1	
plug tail	quantity:1	
clip	L:25mm+screw	
Aluminium	L:1000mm+screw	
Bendable aluminum profile	L:1000mm+screw	
glue	10ml	

Product features

1. Environmental protection silica gel material, plasticity;
2. Low energy consumption, hydrochloric acid resistance, acid and alkali corrosion resistance;
3. Dynamic strong, good effect, economic and practical
- 4.High light transmittance, can be used for indoor and outdoor decoration, improve the city aesthetic feeling,make the citizens feel the charm of the city.



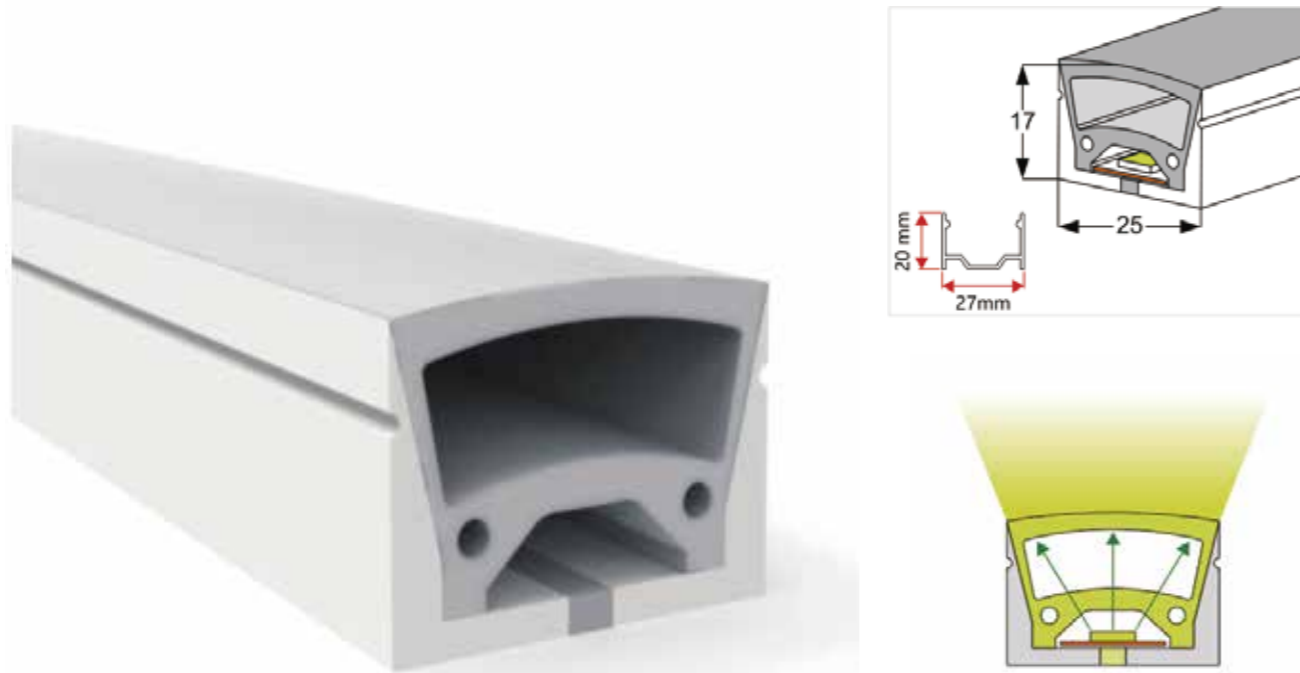

DZ- 17*25 (mm)



Product parameters

Product Number: DZ-17*25 (mm)
 Section size: 17*25
 Light direction: Front light
 Waterproof grade: IP67
 Weight: 320 g/m
 Length: Length can be customized
 Applicable plate width: 12mm
 Number of lamp beads: 60-120leds/m
 Available lamp beads: equal size lamp beads universal

Accessories

name	specifications	graphic
plug	quantity:1	
plug tail	quantity:1	
clip	L:25mm+screw	
Aluminium	L:1000mm+screw	
glue	10ml	

Product features

1. Low temperature, use is not restricted by climate.
2. Low energy consumption, long life.
3. Dynamic strong, good effect, economic and practical.
4. Decorate parks and street lights at night to enhance the aesthetic feeling of the city and make citizens feel the charm of the city.



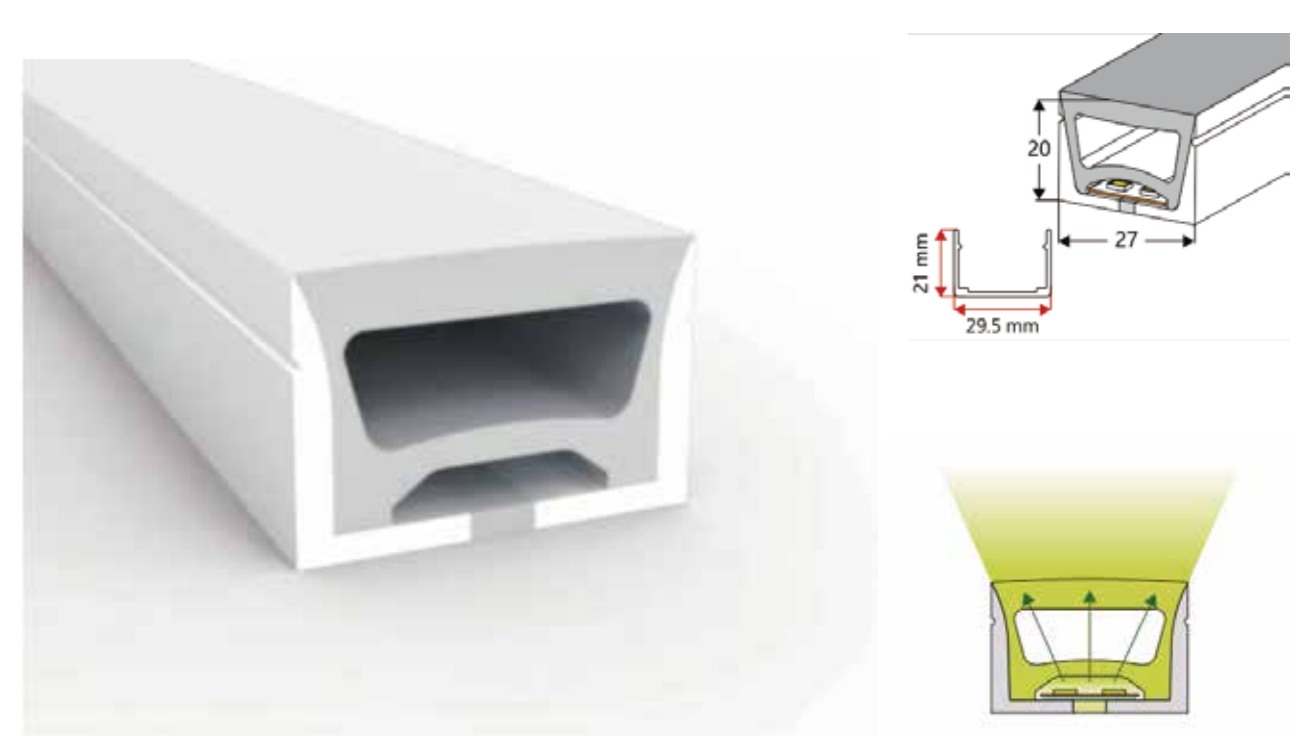

DZ- 27*20 (mm)



Product parameters

Product Number: DZ-27*20(mm)
 Section size: 27*20
 Light direction: Front light
 Waterproof grade: IP67
 Weight: 390 g/m
 Length: Length can be customized
 Applicable plate width: 12/15mm
 Number of lamp beads: 60-120leds/m
 Available lamp beads: equal size lamp beads universal

Accessories

name	specifications	graphic
plug	quantity:1	
plug tail	quantity:1	
clip	L:25mm+screw	
Aluminium	L:1000mm+screw	
glue	10ml	

Product features

1. Low temperature, use is not restricted by climate.
2. Low energy consumption, long life.
3. Dynamic strong, good effect, economic and practical.
4. Decorate parks and street lights at night to enhance the aesthetic feeling of the city and make citizens feel the charm of the city.





DZ-20*20 (mm)



Product parameters

Product Number: DZ-20*20(mm)
 Section size: 20*20
 Light direction: Front light
 Waterproof grade: IP67
 Weight: 280 g/m
 Length: Length can be customized
 Applicable plate width: 10/12mm
 Number of lamp beads: 60-120leds/m
 Available lamp beads: equal size lamp beads universal

Accessories

name	specifications	graphic
plug	quantity:1	
plug tail	quantity:1	
clip	L:25mm+screw	
Aluminium	L:1000mm+screw	
glue	10ml	

Product features

1. Low temperature, use is not restricted by climate.
2. Low energy consumption, long life.
3. Dynamic strong, good effect, economic and practical.
4. Decorate parks and street lights at night to enhance the aesthetic feeling of the city and make citizens feel the charm of the city.





DZ-12*12 (mm)



Product parameters

Product Number: DZ-12*12(mm)
 Section size: 12*12
 Light direction: Front light
 Waterproof grade: IP67
 Weight: 105g/m
 Length: Length can be customized
 Applicable plate width: 8mm
 Number of lamp beads: 60-120leds/m
 Available lamp beads: equal size lamp beads universal

Accessories

name	specifications	graphic
plug	quantity:1	
plug tail	quantity:1	
clip	L:25mm+screw	
Aluminium	L:1000mm+screw	
Bendable aluminum profile	L:1000mm+screw	
glue	10ml	

Product features

1. Low temperature, use is not restricted by climate.
2. Low energy consumption, long life.
3. Dynamic strong, good effect, economic and practical.
4. Decorate parks and street lights at night to enhance the aesthetic feeling of the city and make citizens feel the charm of the city.



DC- 12*20 (mm)

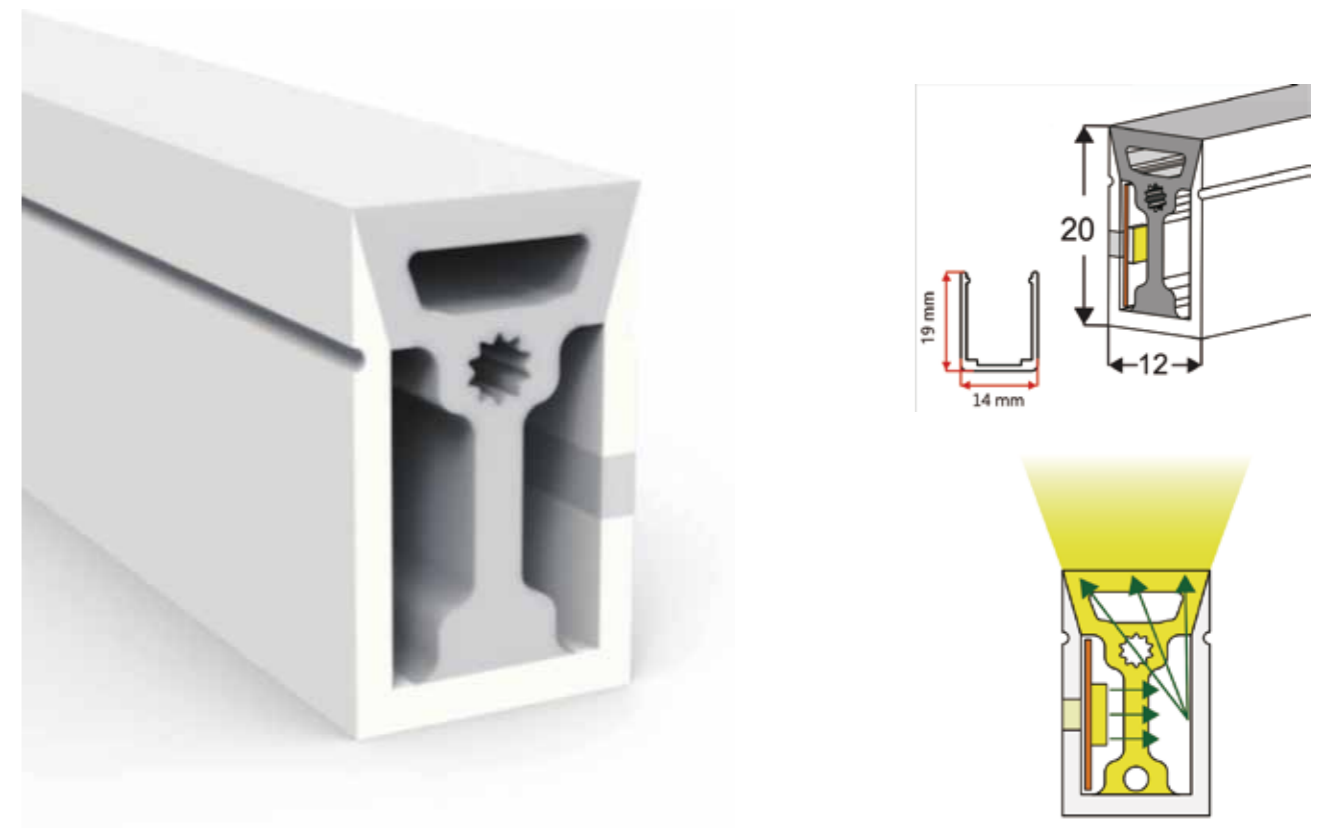

Product parameters

Product Number: SC-12*20(mm)

Section size: 12*20

Light direction: Side luminescent

Waterproof grade: IP67

Weight: 180 g/m

Length: Length can be customized

Applicable plate width: 10/12mm

Number of lamp beads: 60-120leds/m

Available lamp beads: equal size lamp beads universal

Accessories

name	specifications	graphic
plug	quantity:1	
plug tail	quantity:1	
clip	L:25mm+screw	
Aluminium	L:1000mm+screw	
Bendable aluminum profile	L:1000mm+screw	
glue	10ml	

SIDE LUMINESCENT SERIES

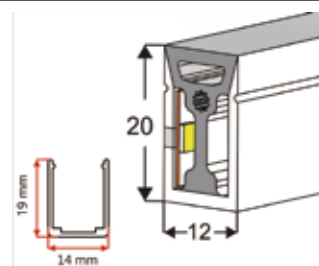

DC- 12*20 (mm)

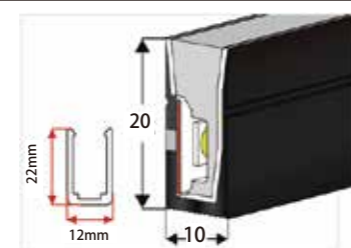

SC- 20*10 (mm)

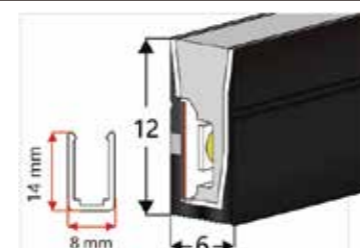

SC- 12*6 (mm)



SC- 16*6 (mm)

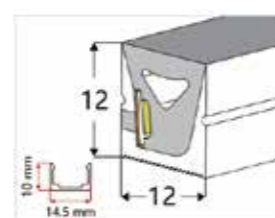

SC- 12*12 (mm)

Product features

1. Environmental protection silica gel material, plasticity;
2. Low energy consumption, long life;
3. Dynamic, good effect, economic and practical;
4. Side luminescent , side bending;
5. Decorate parks and street lights at night to enhance the aesthetic feeling of the city and make citizens feel the charm of the city.



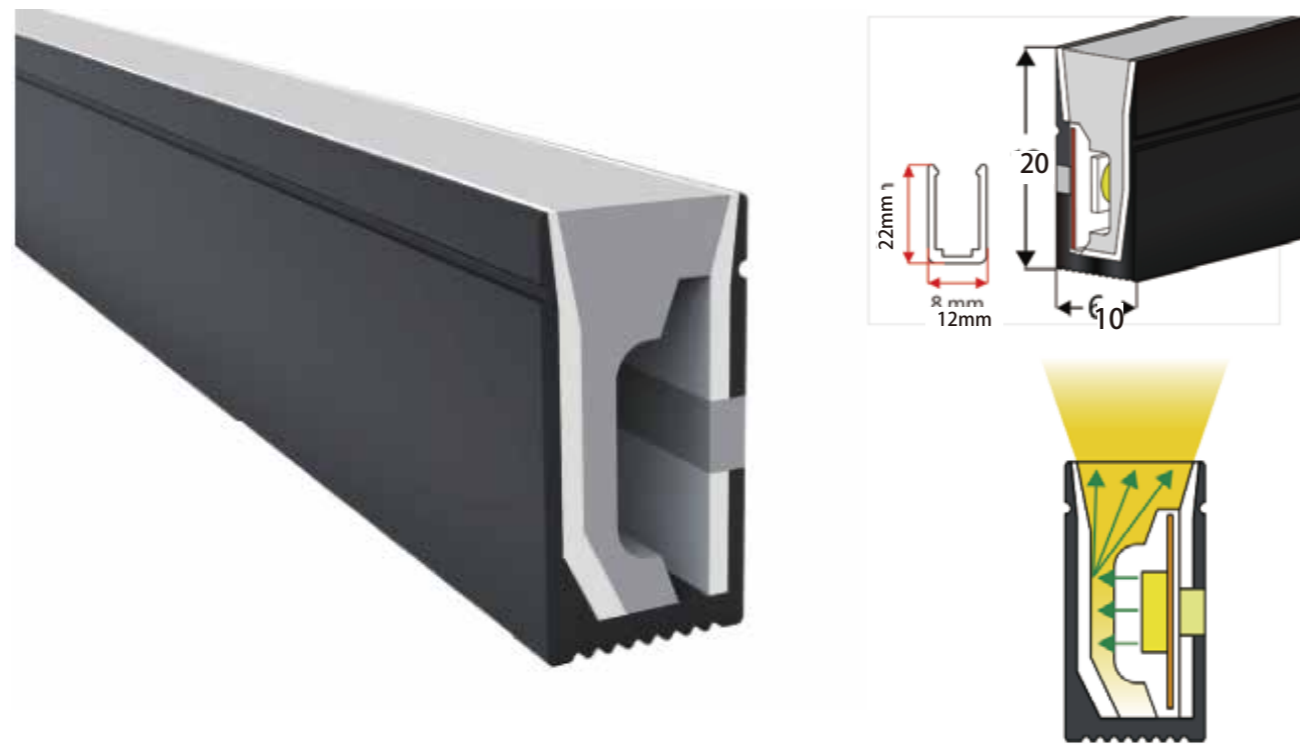

SC- 10*20 (mm)



Product parameters

Product Number: SC-10*20(mm)
 Section size: 10*20
 Light direction: Side luminescent
 Waterproof grade: IP67
 Weight: 175 g/m
 Length: Length can be customized
 Applicable plate width: 10mm
 Number of lamp beads: 60-120leds/m
 Available lamp beads: equal size lamp beads universal

Accessories

name	specifications	graphic
plug	quantity:1	
plug tail	quantity:1	
clip	L:25mm+screw	
Aluminium	L:1000mm+screw	
Bendable aluminum profile	L:1000mm+screw	
glue	10ml	

Product features

1. Environmental protection silica gel material, plasticity;
2. Low energy consumption, long life;
3. Dynamic, good effect, economic and practical;
4. Side luminescent , side bending;
5. Decorate parks and street lights at night to enhance the aesthetic feeling of the city and make citizens feel the charm of the city.

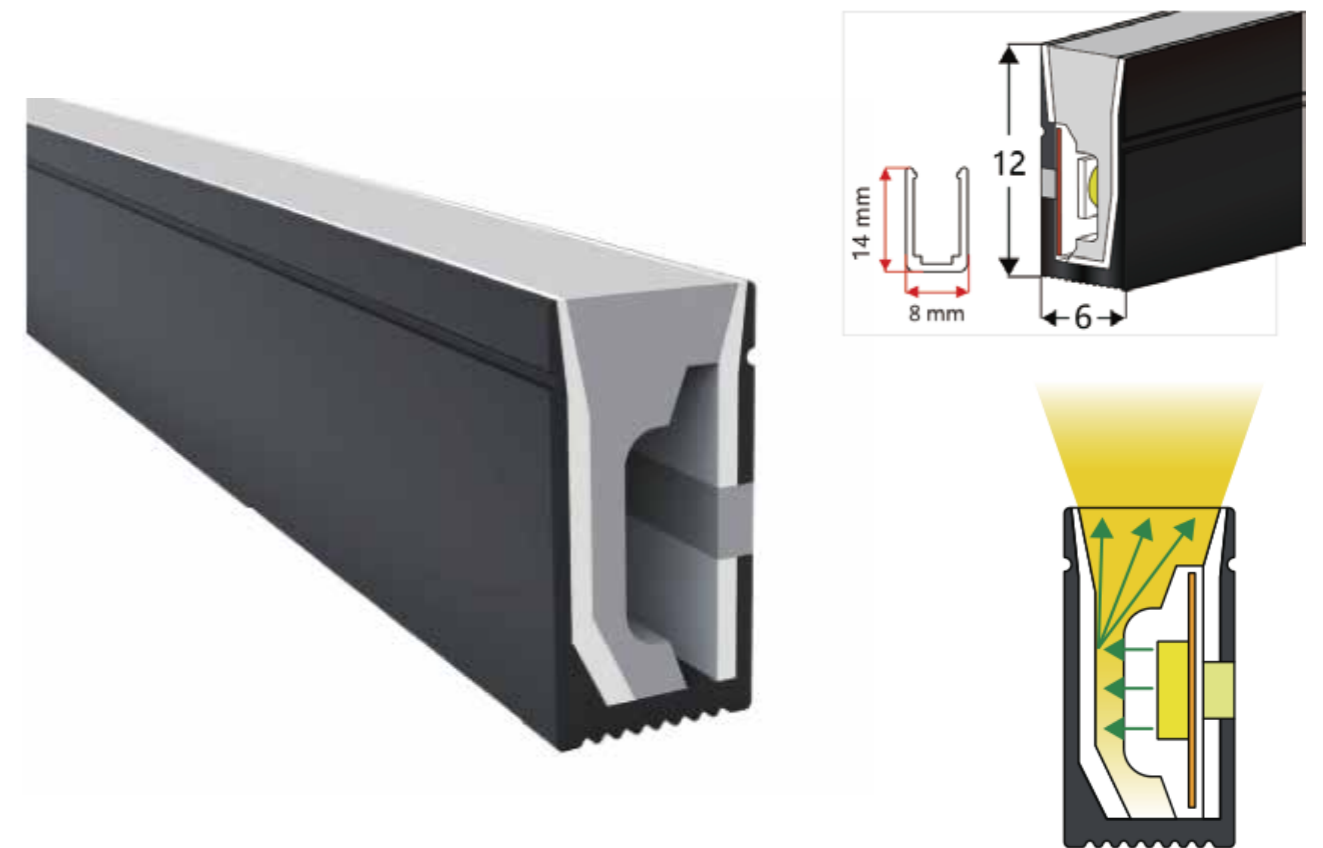

SC-6*12 (mm)



Product parameters

Product Number: SC-6*12(mm)
 Section size: 6*12
 Light direction: Side luminescent
 Waterproof grade: IP67
 Weight: 75 g/m
 Length: Length can be customized
 Applicable plate width: 8mm
 Number of lamp beads: 120leds/m
 Available lamp beads: equal size lamp beads universal

Accessories

name	specifications	graphic
plug	quantity:1	
plug tail	quantity:1	
clip	L:25mm+screw	
Aluminium	L:1000mm+screw	
Bendable aluminum profile	L:1000mm+screw	
glue	10ml	

Product features

1. Environmental protection silica gel material, plasticity;
2. Low energy consumption, long life;
3. Dynamic, good effect, economic and practical;
4. Side luminescent , side bending;
5. Decorate parks and street lights at night to enhance the aesthetic feeling of the city and make citizens feel the charm of the city.





SC-6*16 (mm)



Product parameters

Product Number: SC-6*16(mm)
 Section size: 6*16
 Light direction: Side luminescent
 Waterproof grade: IP67
 Weight: 89 g/m
 Length: Length can be customized
 Applicable plate width: 8mm
 Number of lamp beads: 120leds/m
 Available lamp beads: equal size lamp beads universal

Accessories

name	specifications	graphic
plug	quantity:1	
plug tail	quantity:1	
clip	L:25mm+screw	
Aluminium	L:1000mm+screw	
Bendable aluminum profile	L:1000mm+screw	
glue	10ml	

Product features

1. Environmental protection silica gel material, plasticity;
2. Low energy consumption, long life;
3. Dynamic, good effect, economic and practical;
4. Side luminescent , side bending;
5. Decorate parks and street lights at night to enhance the aesthetic feeling of the city and make citizens feel the charm of the city.





DC-12*12 (mm)



Product parameters

Product Number: DC-12*12 (mm)
 Section size: 12*12
 Light direction: Side luminescent
 Waterproof grade: IP67
 Weight: 150 g/m
 Length: Length can be customized
 Applicable plate width: 5mm
 Number of lamp beads: 60-120leds/m
 Available lamp beads: equal size lamp beads universal

Accessories

name	specifications	graphic
plug	quantity:1	
plug tail	quantity:1	
clip	L:25mm+screw	
Aluminium	L:1000mm+screw	
Bendable aluminum profile	L:1000mm+screw	
glue	10ml	

Product features

1. Environmental protection silica gel material, plasticity;
2. Low energy consumption, hydrochloric acid resistance, acid and alkali corrosion resistance;
3. Dynamic strong, good effect, economic and practical
- 4.High light transmittance, can be used for indoor and outdoor decoration, improve the city aesthetic feeling,make the citizens feel the charm of the city.



DC- 12*20 (mm)

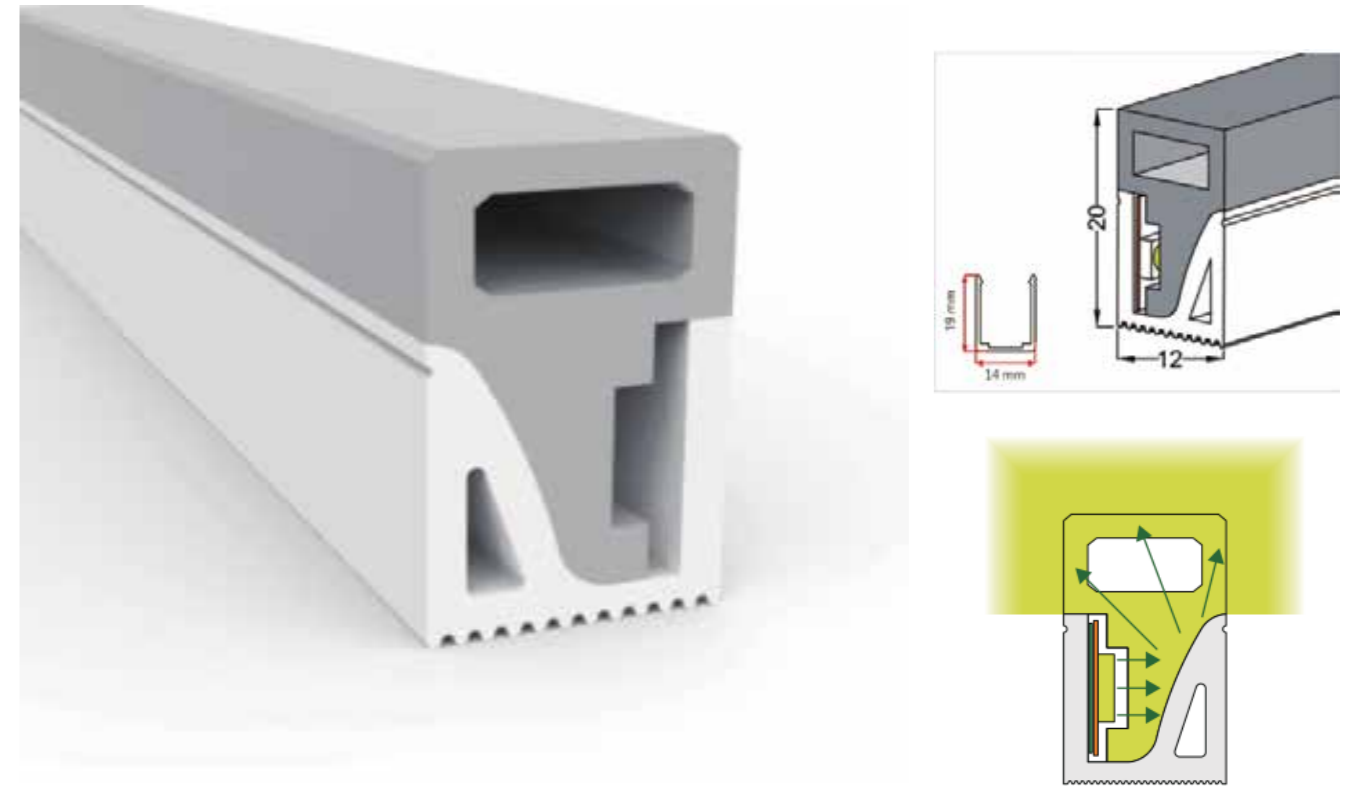

THREE SIDE LUMINESCENCE SERIES

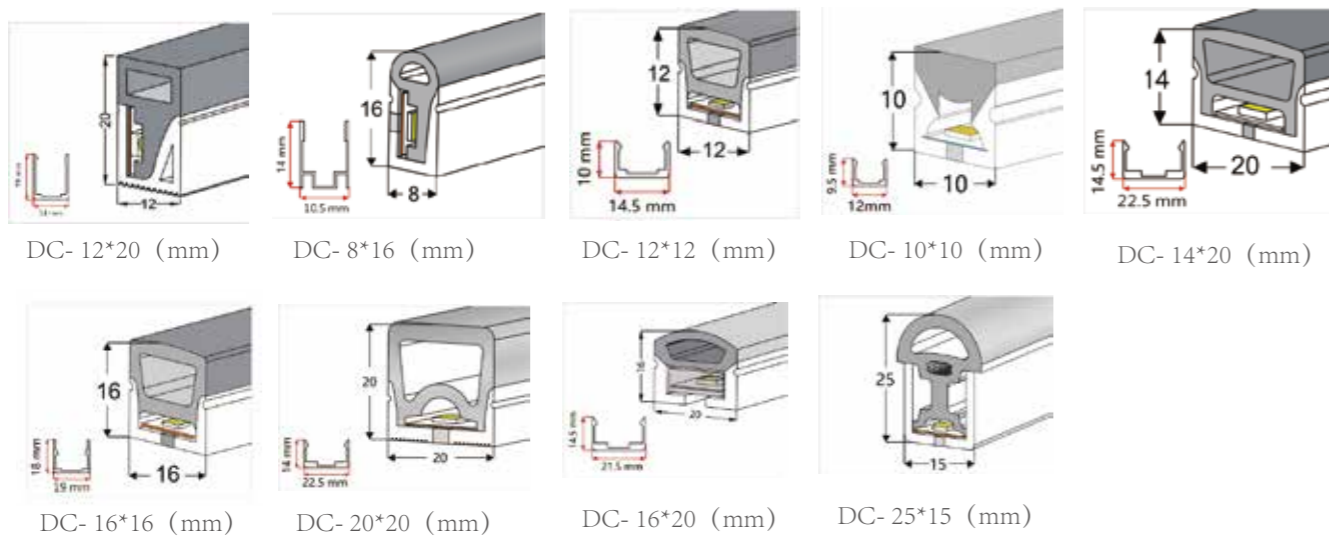

Product parameters

Product Number: DC-12*20(mm)

Section size: 12*20

Light direction: Side glow on three sides

Waterproof grade: IP67

Weight: 225 g/m

Length: Length can be customized

Applicable plate width: 10/12mm

Number of lamp beads: 60-120leds/m

Available lamp beads: equal size lamp beads universal

Accessories

name	specifications	graphic
plug	quantity:1	
plug tail	quantity:1	
clip	L:25mm+screw	
Aluminium	L:1000mm+screw	
Bendable aluminum profile	L:1000mm+screw	
glue	10ml	

Product features

1. Environmental protection silica gel material, plasticity;
2. Low energy consumption, long life;
3. Dynamic, good effect, economic and practical;
4. Side luminescent , side bending;
5. Decorate parks and street lights at night to enhance the aesthetic feeling of the city and make citizens feel the charm of the city.



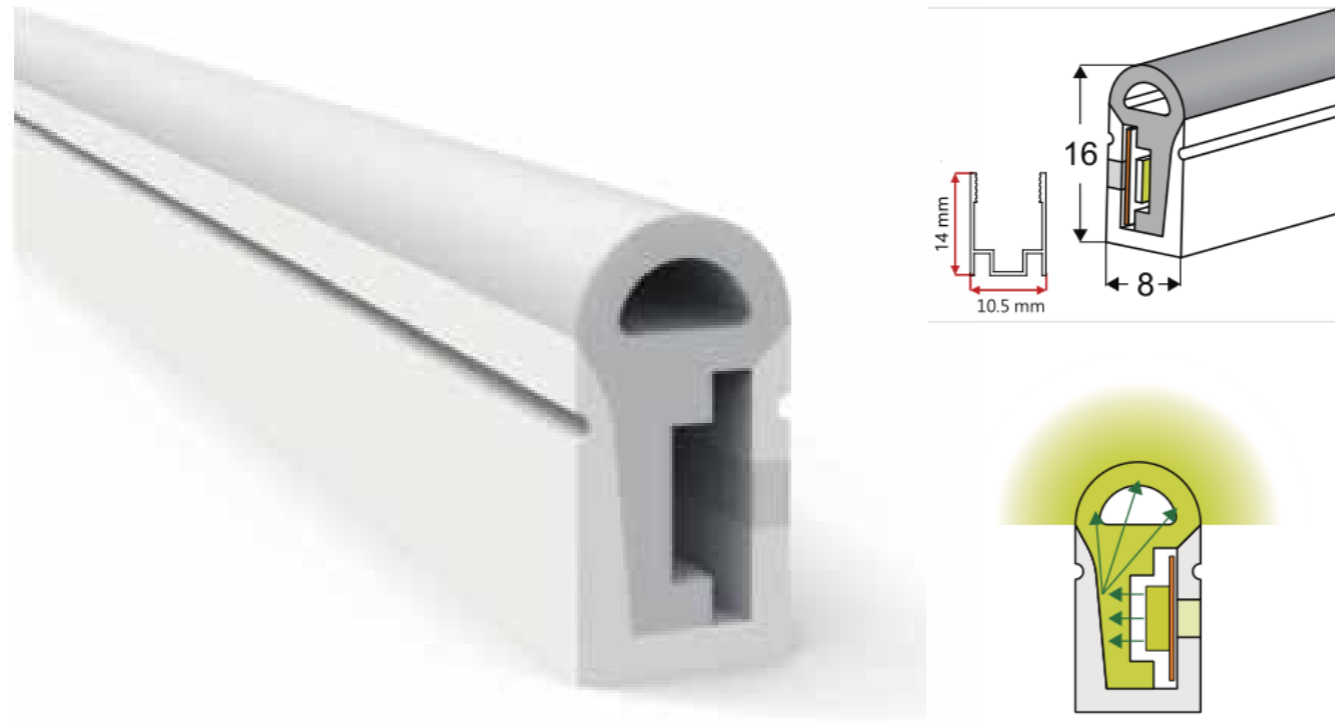

DC-8*16 (mm)



Product parameters

Product Number: DC-8*16(mm)
 Section size: 8*16
 Light direction: Side glow on three sides
 Waterproof grade: IP67
 Weight: 225 g/m
 Length: Length can be customized
 Applicable plate width: 10/12mm
 Number of lamp beads: 60-120leds/m
 Available lamp beads: equal size lamp beads universal

Accessories

name	specifications	graphic
plug	quantity:1	
plug tail	quantity:1	
clip	L:25mm+screw	
Aluminium	L:1000mm+screw	
Bendable aluminum profile	L:1000mm+screw	
glue	10ml	

Product features

1. Environmental protection silica gel material, plasticity;
2. Low energy consumption, long life;
3. Dynamic, good effect, economic and practical;
4. Side luminescent , side bending;
5. Decorate parks and street lights at night to enhance the aesthetic feeling of the city and make citizens feel the charm of the city.



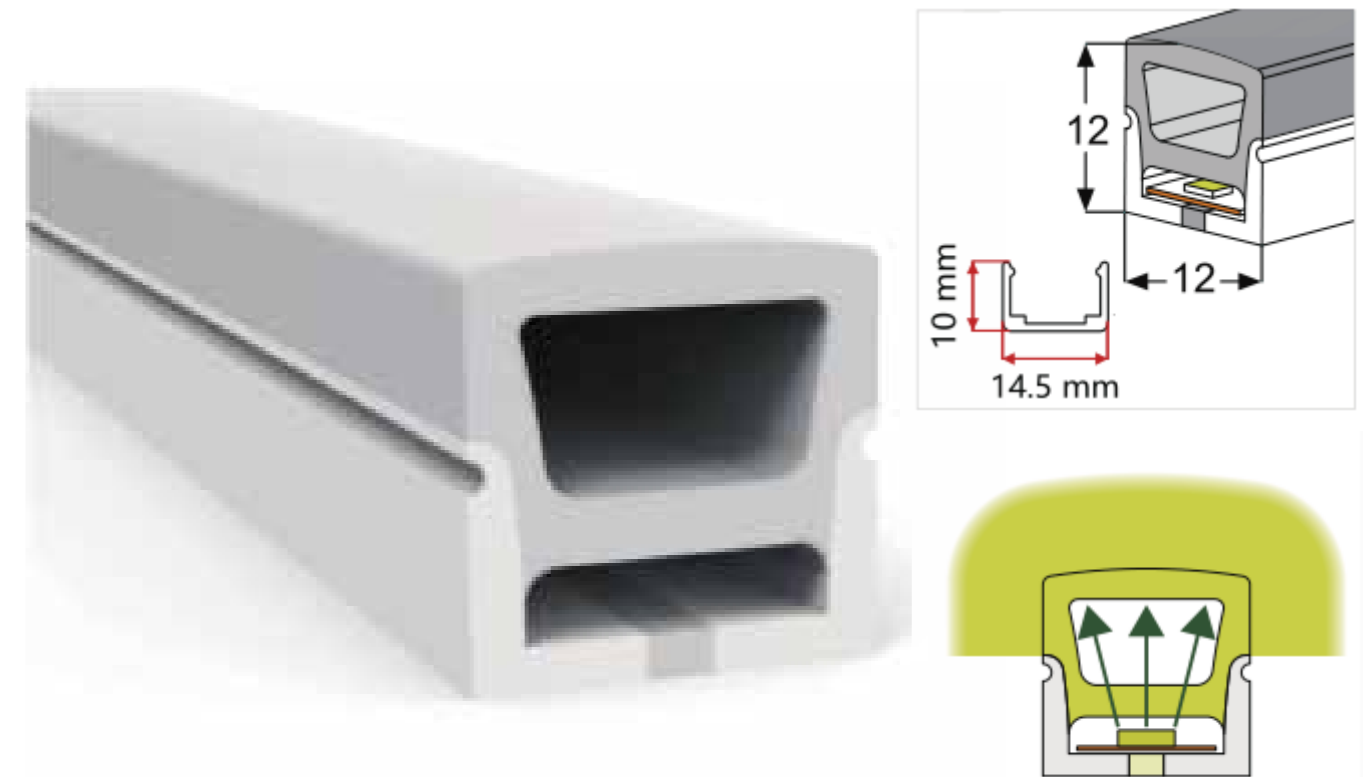

DZ-12*12 (mm)



Product parameters

Product Number: DZ-12*12(mm)
 Section size: 12*12
 Light direction: Front light on three sides
 Waterproof grade: IP67
 Weight: 102 g/m
 Length: Length can be customized
 Applicable plate width: 8mm
 Number of lamp beads: 60-120leds/m
 Available lamp beads: equal size lamp beads universal

Accessories

name	specifications	graphic
plug	quantity:1	
plug tail	quantity:1	
clip	L:25mm+screw	
Aluminium	L:1000mm+screw	
Bendable aluminum profile	L:1000mm+screw	
glue	10ml	

Product features

1. Low temperature, use is not restricted by climate.
2. Low energy consumption, long life.
3. Dynamic strong, good effect, economic and practical.
4. Decorate parks and street lights at night to enhance the aesthetic feeling of the city and make citizens feel the charm of the city.



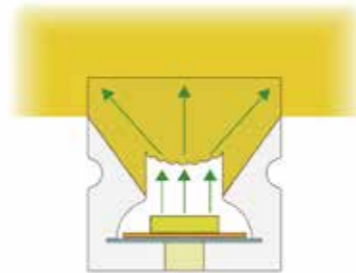
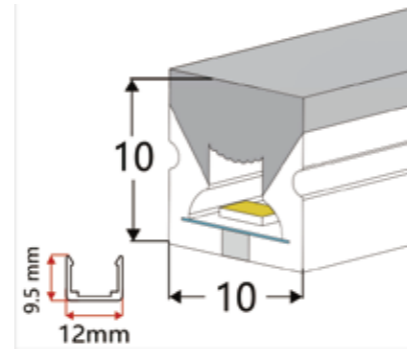

DZ- 10*10 (mm)



Product parameters

Product Number: DZ-10*10(mm)
 Section size: 10*10
 Light direction: Front light on three sides
 Waterproof grade: IP67
 Weight: 104 g/m
 Length: Length can be customized
 Applicable plate width: 5/6mm
 Number of lamp beads: 120leds/m
 Available lamp beads: equal size lamp beads universal

Accessories

name	specifications	graphic
plug	quantity:1	
plug tail	quantity:1	
clip	L:25mm+screw	
Aluminium	L:1000mm+screw	
Bendable aluminum profile	L:1000mm+screw	
glue	10ml	

Product features

1. Low temperature, use is not restricted by climate.
2. Low energy consumption, long life.
3. Dynamic strong, good effect, economic and practical.
4. Decorate parks and street lights at night to enhance the aesthetic feeling of the city and make citizens feel the charm of the city.



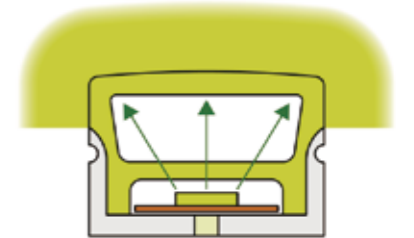
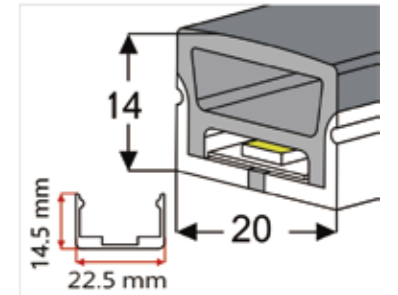

DZ- 14*20 (mm)



Product parameters

Product Number: DZ-14*20(mm)
 Section size: 14*20
 Light direction: Front light on three sides
 Waterproof grade: IP67
 Weight: 249 g/m
 Length: Length can be customized
 Applicable plate width: 10/12mm
 Number of lamp beads: 60-20leds/m
 Available lamp beads: equal size lamp beads universal

Accessories

name	specifications	graphic
plug	quantity:1	
plug tail	quantity:1	
clip	L:25mm+screw	
Aluminium	L:1000mm+screw	
Bendable aluminum profile	L:1000mm+screw	
glue	10ml	

Product features

1. Environmental protection silica gel material, plasticity;
2. Low energy consumption, long life;
3. Dynamic, good effect, economic and practical;
4. Side luminescent, side bending;
5. Decorate parks and street lights at night to enhance the aesthetic feeling of the city and make citizens feel the charm of the city.



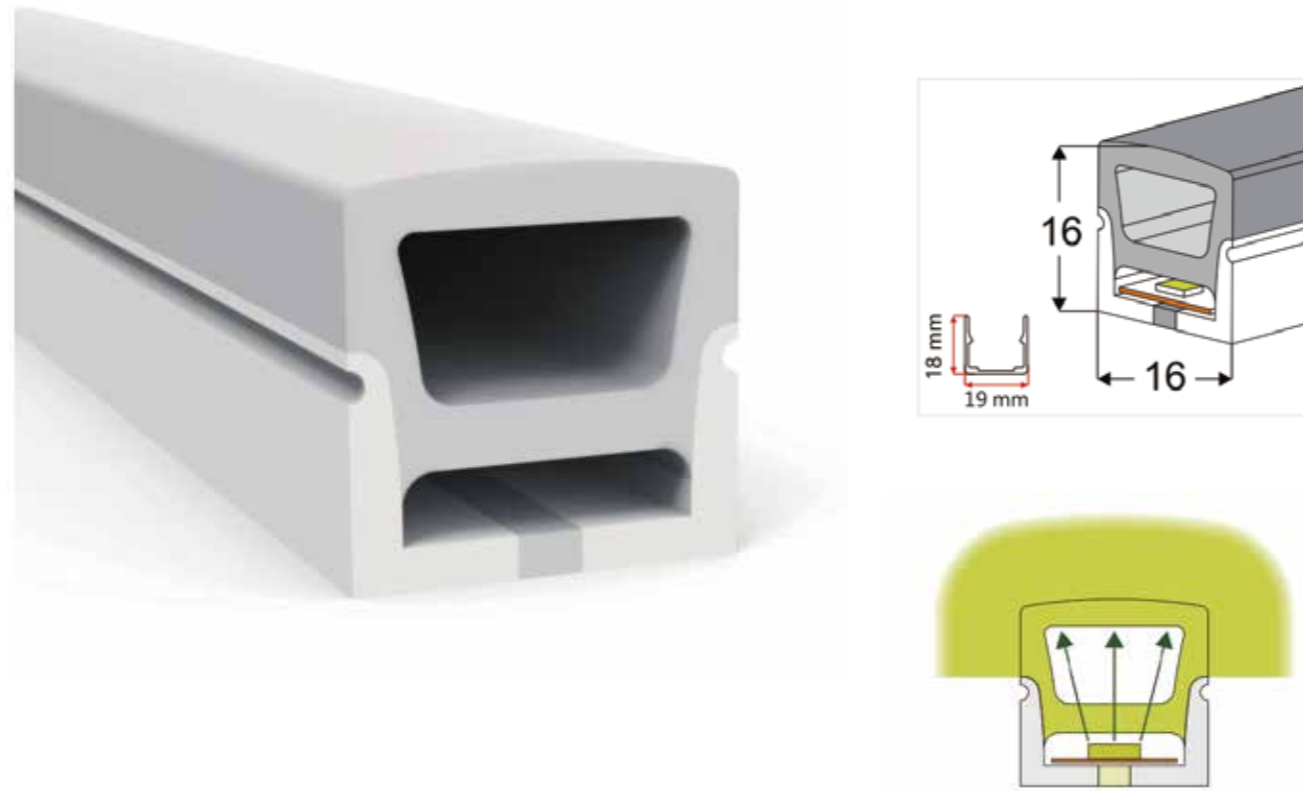

DZ-16*16 (mm)



Product parameters

Product Number: DZ-16*16(mm)
 Section size: 16*16
 Light direction: Front light on three sides
 Waterproof grade: IP67
 Weight: 185g/m
 Length: Length can be customized
 Applicable plate width: 12mm
 Number of lamp beads: 60-20leds/m
 Available lamp beads: equal size lamp beads universal

Accessories

name	specifications	graphic
plug	quantity:1	
plug tail	quantity:1	
clip	L:25mm+screw	
Aluminium	L:1000mm+screw	
Bendable aluminum profile	L:1000mm+screw	
glue	10ml	

Product features

1. Environmental protection silica gel material, plasticity;
2. Low energy consumption, long life;
3. Dynamic, good effect, economic and practical;
4. Side luminescent , side bending;
5. Decorate parks and street lights at night to enhance the aesthetic feeling of the city and make citizens feel the charm of the city.



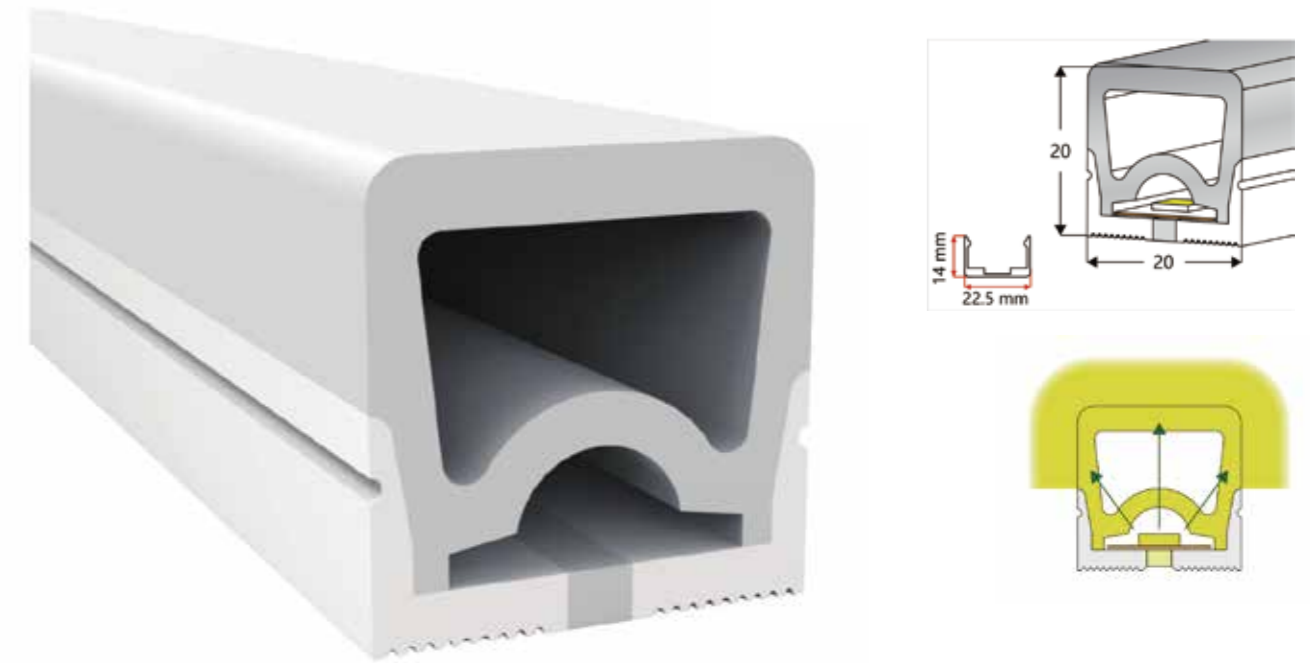

DZ-20*20 (mm)



Product parameters

Product Number: DZ-20*20(mm)
 Section size: 20*20
 Light direction: Front light on three sides
 Waterproof grade: IP67
 Weight: 100g/m
 Length: Length can be customized
 Applicable plate width: 10/12mm
 Number of lamp beads: 60-20leds/m
 Available lamp beads: equal size lamp beads universal

Accessories

name	specifications	graphic
plug	quantity:1	
plug tail	quantity:1	
clip	L:25mm+screw	
Aluminium	L:1000mm+screw	
Bendable aluminum profile	L:1000mm+screw	
glue	10ml	

Product features

1. Environmental protection silica gel material, plasticity;
2. Low energy consumption, long life;
3. Dynamic, good effect, economic and practical;
4. Side luminescent , side bending;
5. Decorate parks and street lights at night to enhance the aesthetic feeling of the city and make citizens feel the charm of the city.

DZ- 20*16 (mm)

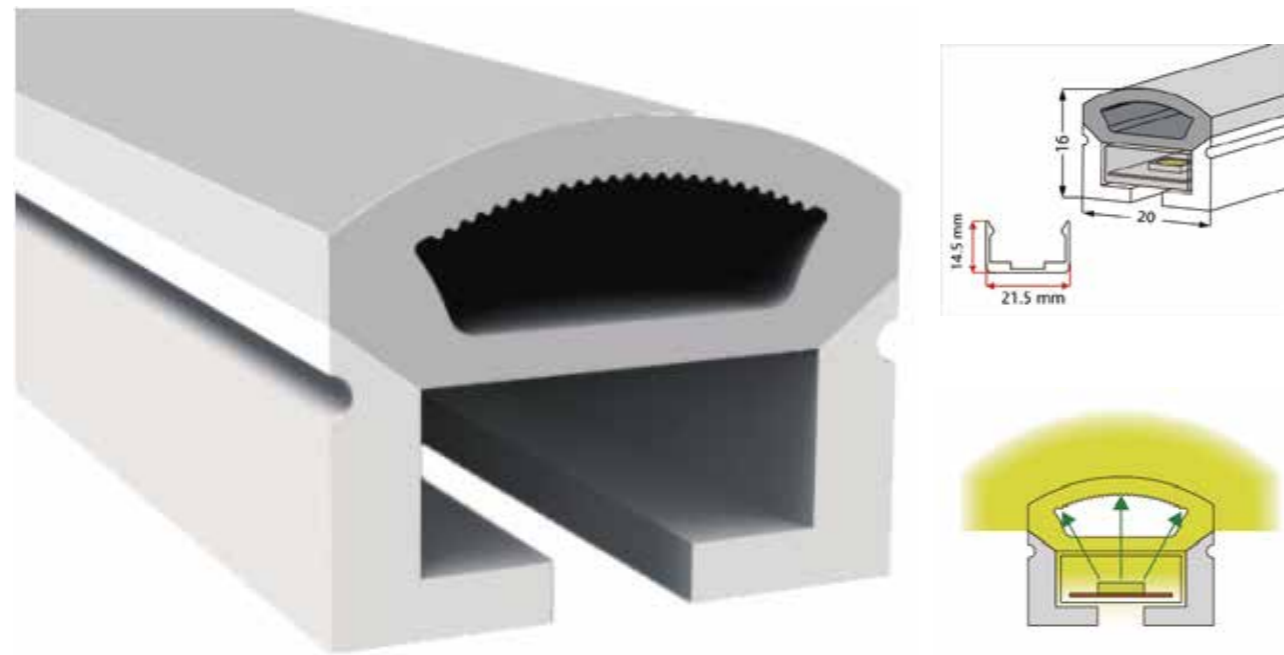

Product parameters

Product Number: DZ-20*16(mm)
 Section size: 20*16
 Light direction: Front light on three sides
 Waterproof grade: IP67
 Weight: 320g/m
 Length: Length can be customized
 Applicable plate width: 10mm
 Number of lamp beads: 60-20leds/m
 Available lamp beads: equal size lamp beads universal

Accessories

name	specifications	graphic
plug	quantity:1	
plug tail	quantity:1	
clip	L:25mm+screw	
Aluminium	L:1000mm+screw	
Bendable aluminum profile	L:1000mm+screw	
glue	10ml	

Product features

1. Low temperature, use is not restricted by climate.
2. Low energy consumption, long life.
3. Dynamic strong, good effect, economic and practical.
4. Decorate parks and street lights at night to enhance the aesthetic feeling of the city and make citizens feel the charm of the city.

DZ-15*25 (mm)

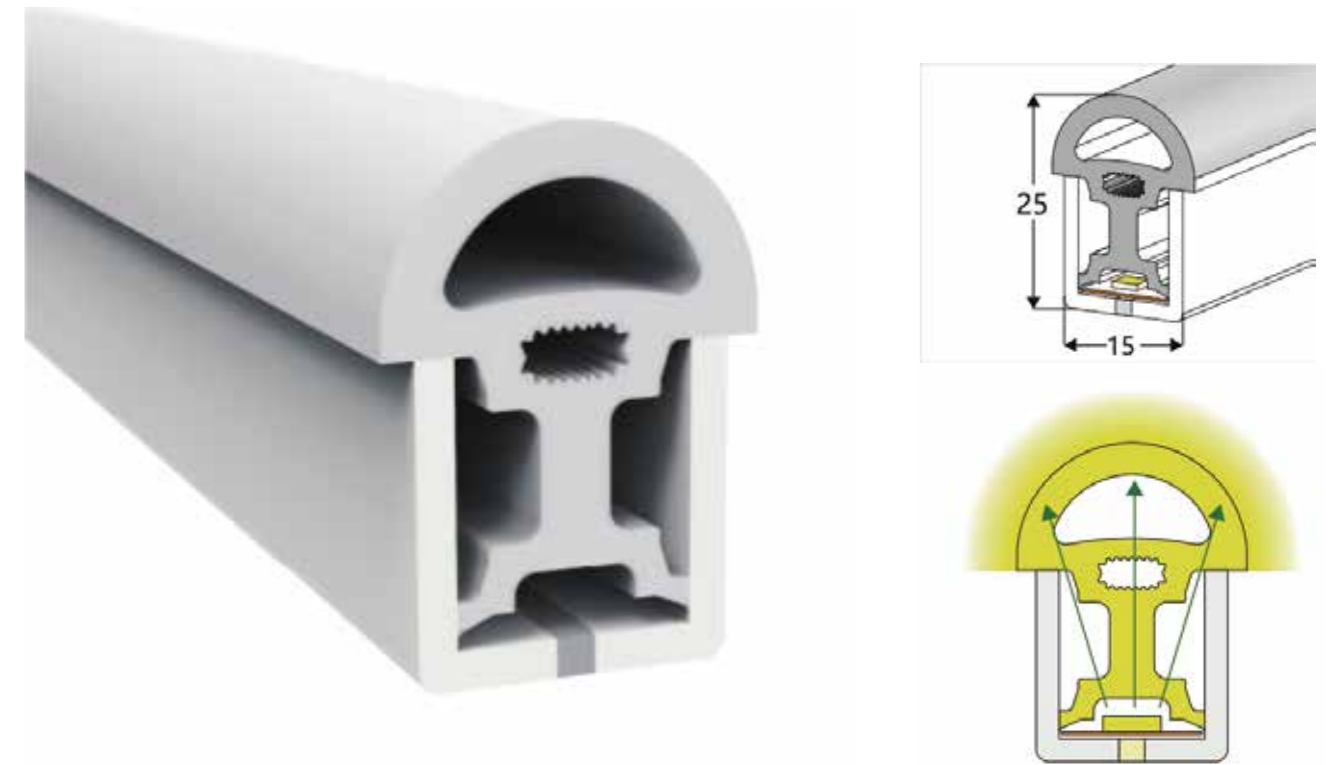

Product parameters

Product Number: DZ-15*25(mm)
 Section size: 15*25
 Light direction: Front light on three sides
 Waterproof grade: IP67
 Weight: 320g/m
 Length: Length can be customized
 Applicable plate width: 10/12mm
 Number of lamp beads: 60-20leds/m
 Available lamp beads: equal size lamp beads universal

Accessories

name	specifications	graphic
plug	quantity:1	
plug tail	quantity:1	
clip	L:25mm+screw	
Aluminium	L:1000mm+screw	
Bendable aluminum profile	L:1000mm+screw	
glue	10ml	

Product features

1. Low temperature, use is not restricted by climate.
2. Low energy consumption, long life.
3. Dynamic strong, good effect, economic and practical.
4. Decorate parks and street lights at night to enhance the aesthetic feeling of the city and make citizens feel the charm of the city.



360° FULL LUMINESCENCE SERIES

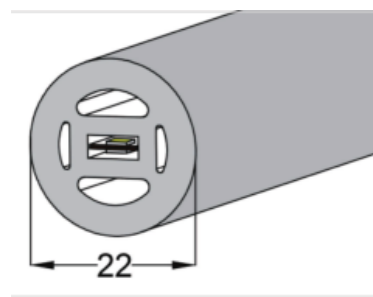

DQ-Ø22(mm)360°

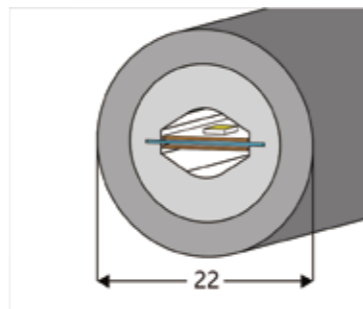

DQ-Ø22(mm)360°

DQ-Ø22(mm)360°

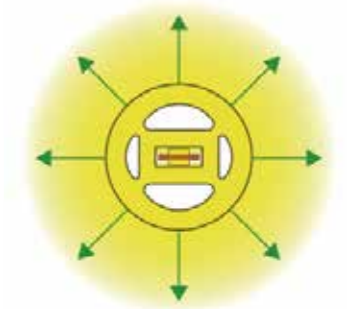
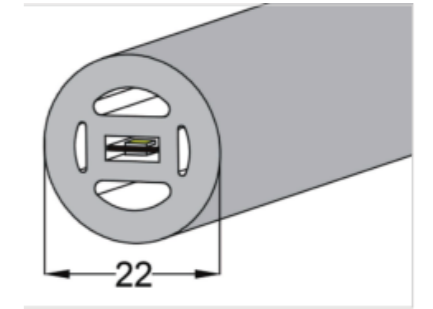

Product parameters

Product Number: DQ-Ø22 (mm) 360°

Section size: Ø22mm

Luminescence direction: 360° luminescence

Waterproof grade: IP67

Weight: 75 g/m



Length: Length can be customized

Applicable plate width: 5/6mm

Lamp bead number: 60-120leds/m

Available lamp beads: equal size lamp beads universal

Accessories

name	specifications	graphic
plug	quantity:1	
plug tail	quantity:1	
clip	L:25mm+screw	
glue	10ml	

Product features

1. low temperature, use is not restricted by climate;
2. low energy consumption, long life;
3. innovative technology, 360° full light, no dark area dead Angle;
4. soft material, with system application solutions, to meet the needs of any modeling;
5. Decorate parks and street lights at night to enhance the aesthetic feeling of the city and make citizens feel the charm of the city.

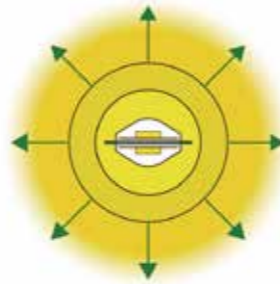
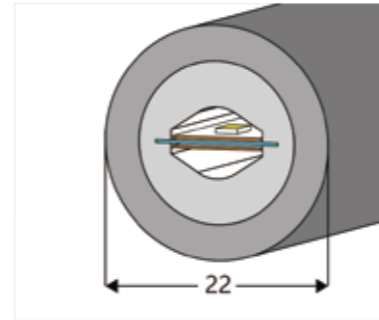
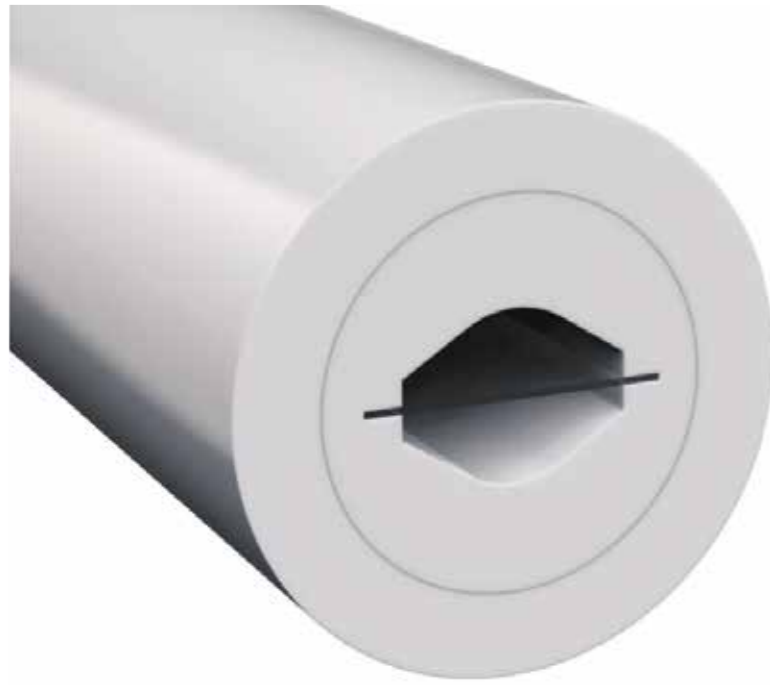

DQ-Ø22(mm)360°



Product parameters

Product Number: DQ-Ø22 (mm) 360°
Section size: Ø22mm
Luminescence direction: 360° luminescence
Waterproof grade: IP67
Weight: 75 g/m
Length: Length can be customized
Applicable plate width: 5/6mm
Lamp bead number: 60-120leds/m
Available lamp beads: equal size lamp beads universal

Accessories

name	specifications	graphic
plug	quantity:1	
plug tail	quantity:1	
clip	L:25mm+screw	
glue	10ml	

Product features

1. low temperature, use is not restricted by climate;
2. low energy consumption, long life;
3. innovative technology, 360° full light, no dark area dead Angle;
4. soft material, with system application solutions, to meet the needs of any modeling;
5. Decorate parks and street lights at night to enhance the aesthetic feeling of the city and make citizens feel the charm of the city.

