

KEY PLAN (SCALE 1-3000/A2)

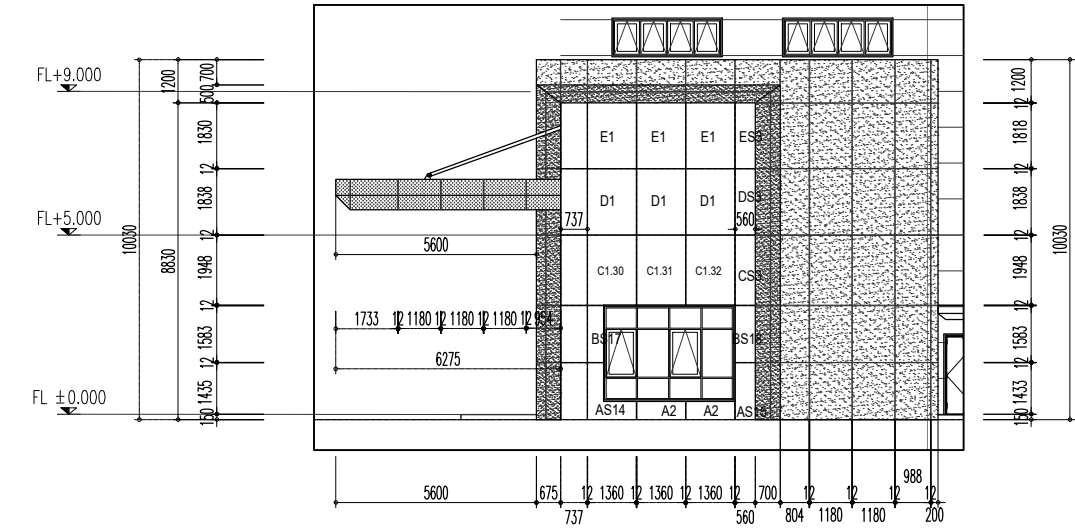

PERSPECTIVE ILLUSTRATION



ELEVATION ALUMINUM FACADE LAYOUT DRAWING AXIS X31 (Y1-Y2) (SCALE 1-200/A2)

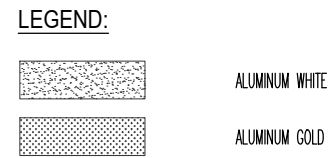
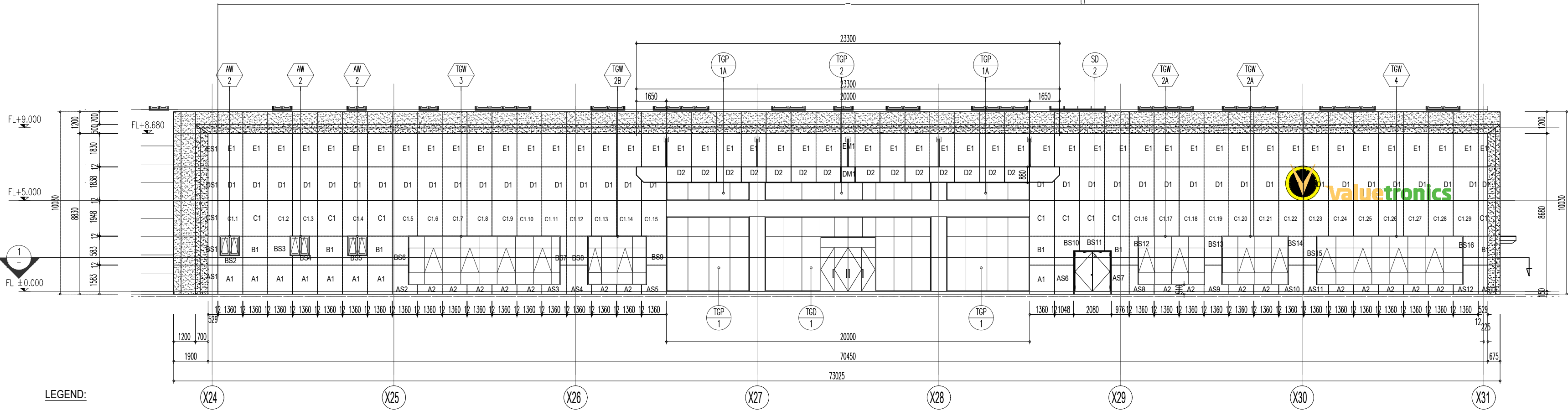

ELEVATION ALUMINUM BOX PARTITION AXIS Y1 (X22-X31) (SCALE 1-200/A2)

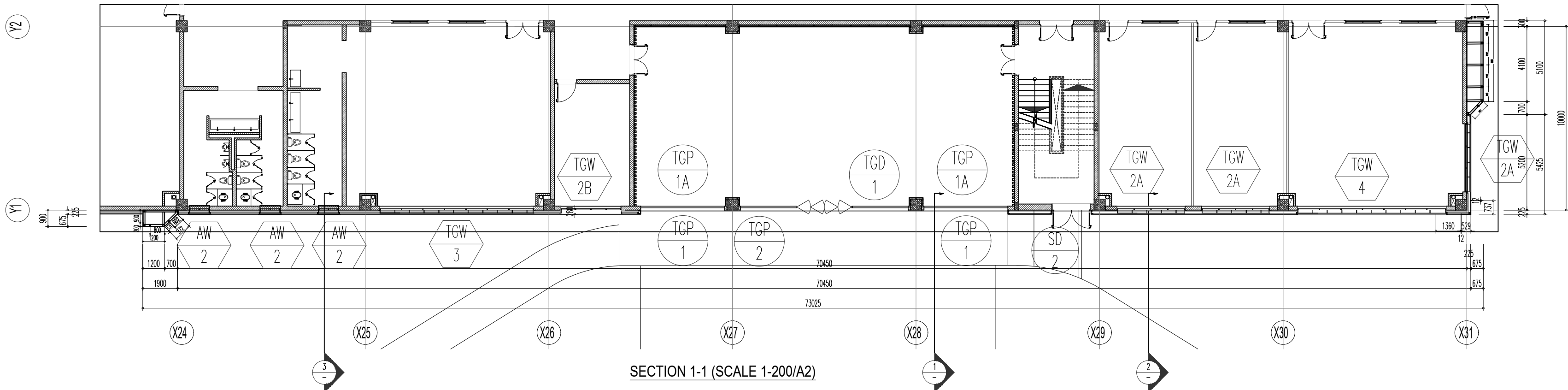

SECTION 1-1 (SCALE 1-200/A2)

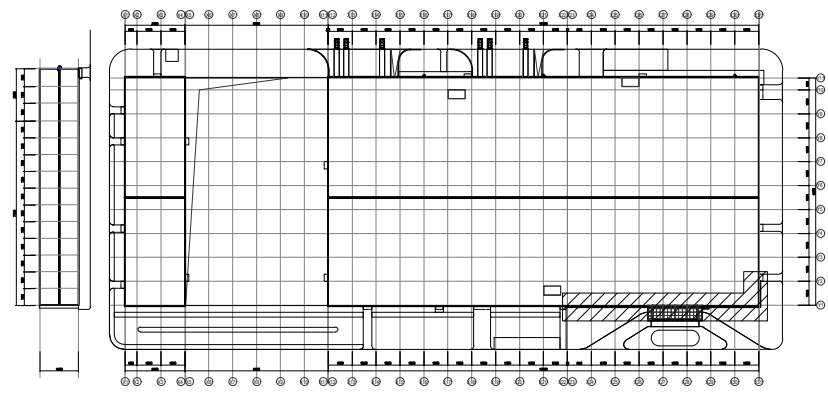

KEY PLAN (SCALE 1-3000/A2)

LEGEND
 ALUMINIUM BOX PARTITION



PERSPECTIVE ILLUSTRATION

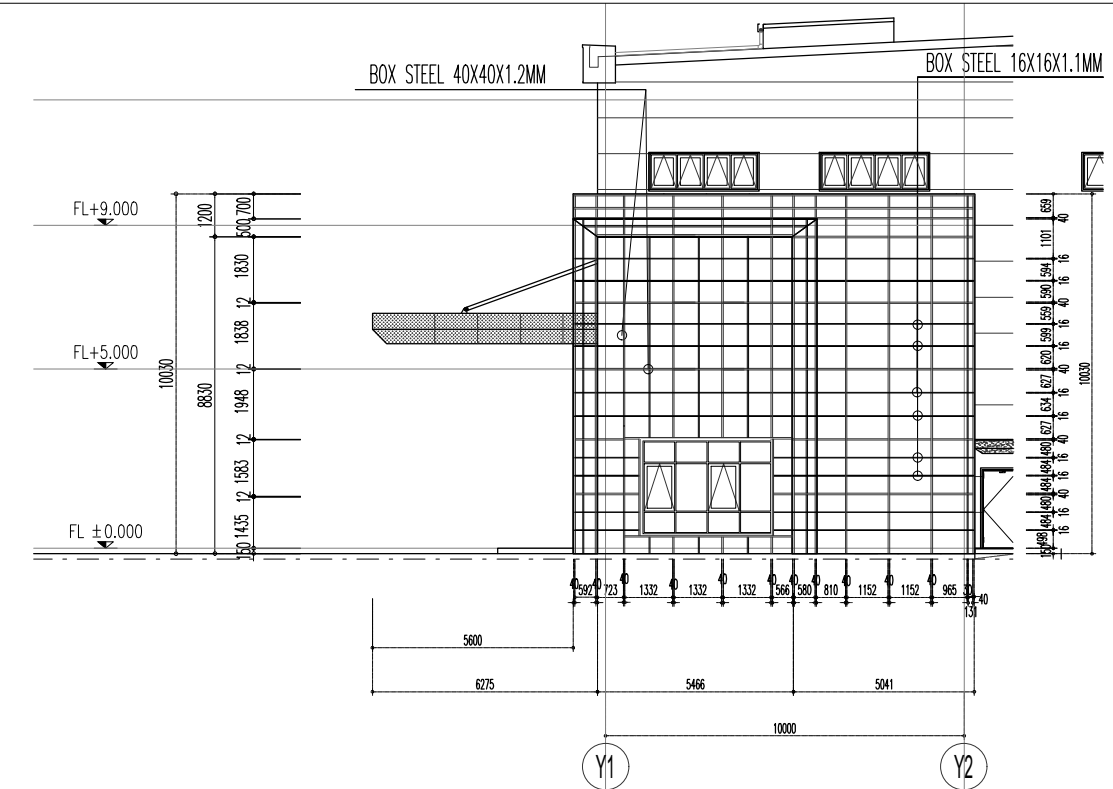

ELEVATION STEEL SUPORT FRAME AXIS X31 (Y1-Y11) (SCALE 1-200/A2)

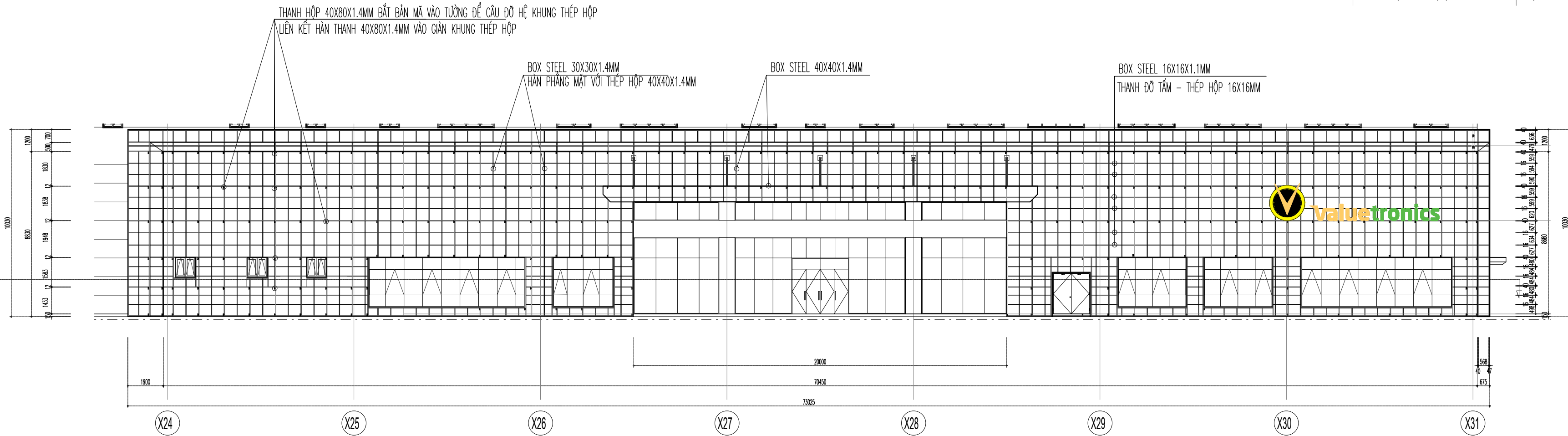

ELEVATION ALUMINIUM STEEL SUPORT FRAME AXIS Y1 (X22-X31) (SCALE 1-200/A2)

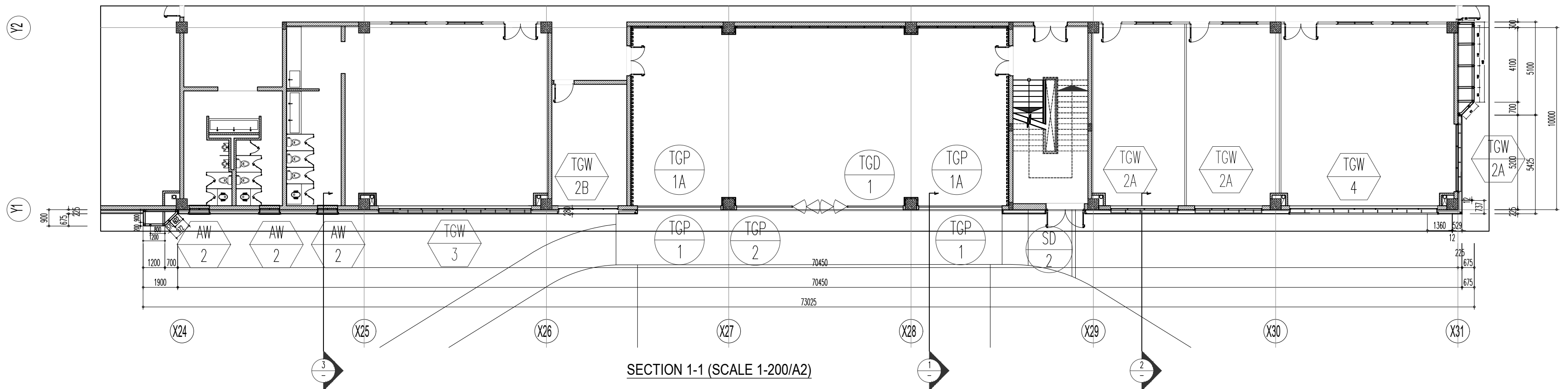

SECTION 1-1 (SCALE 1-200/A2)

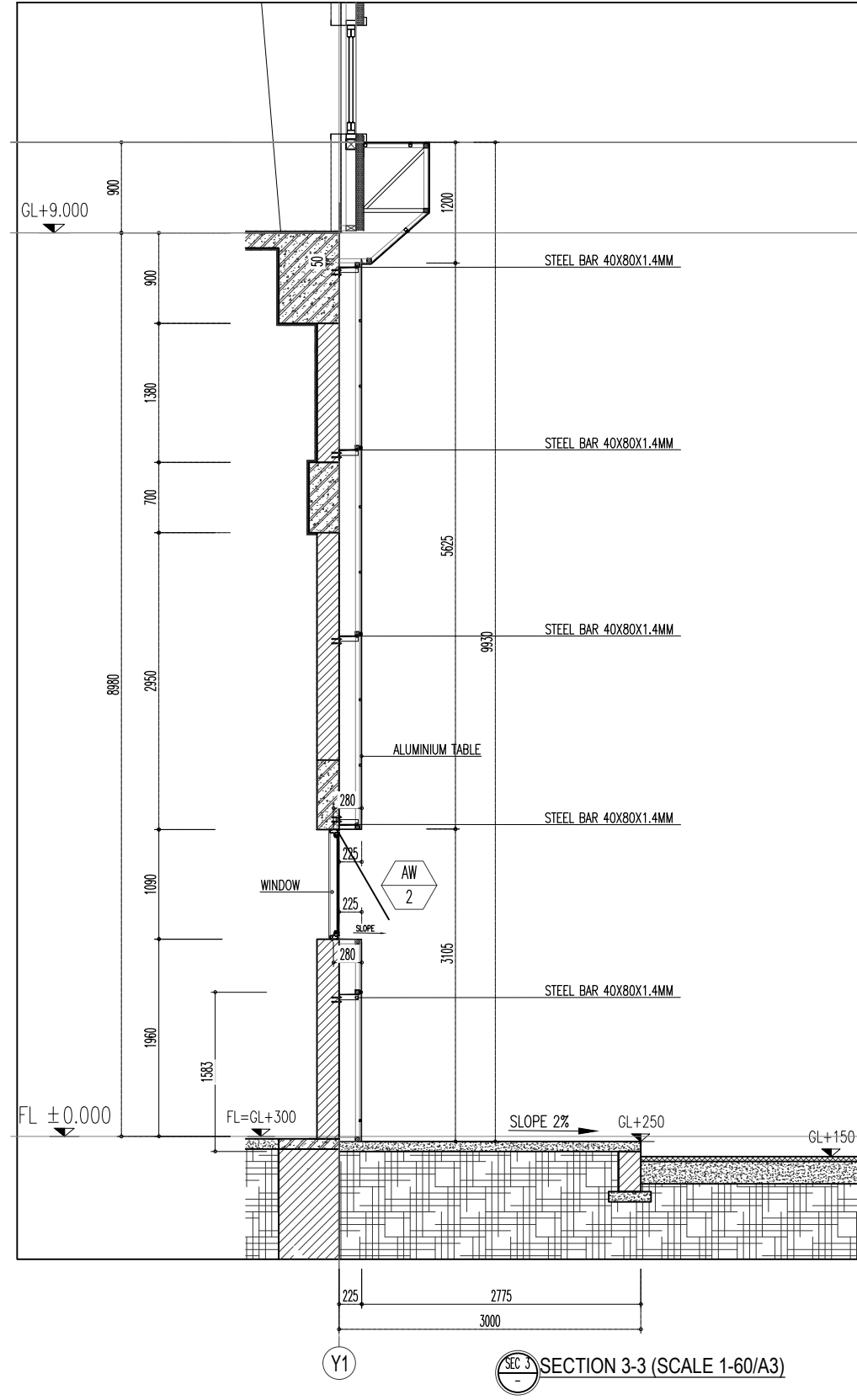
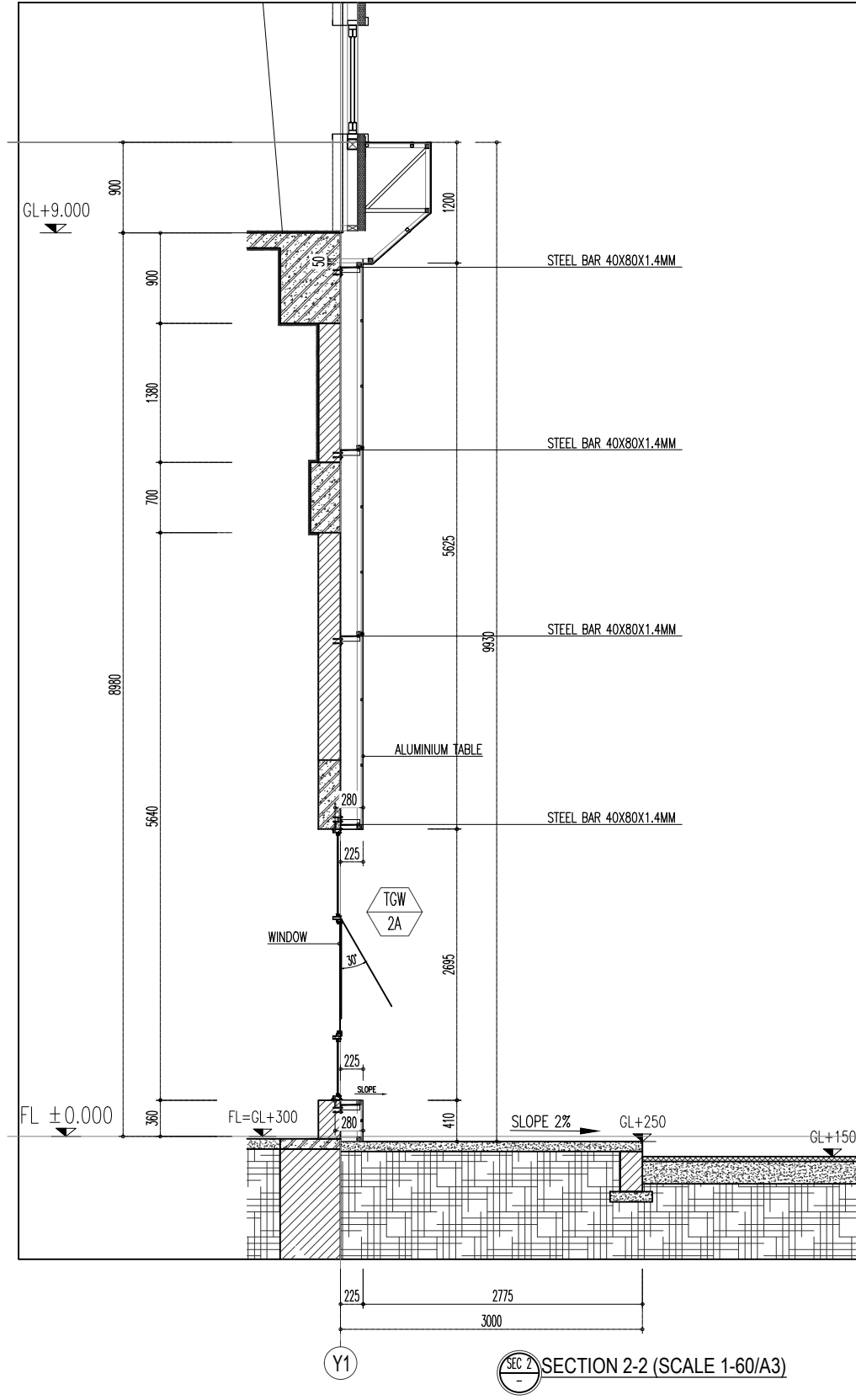
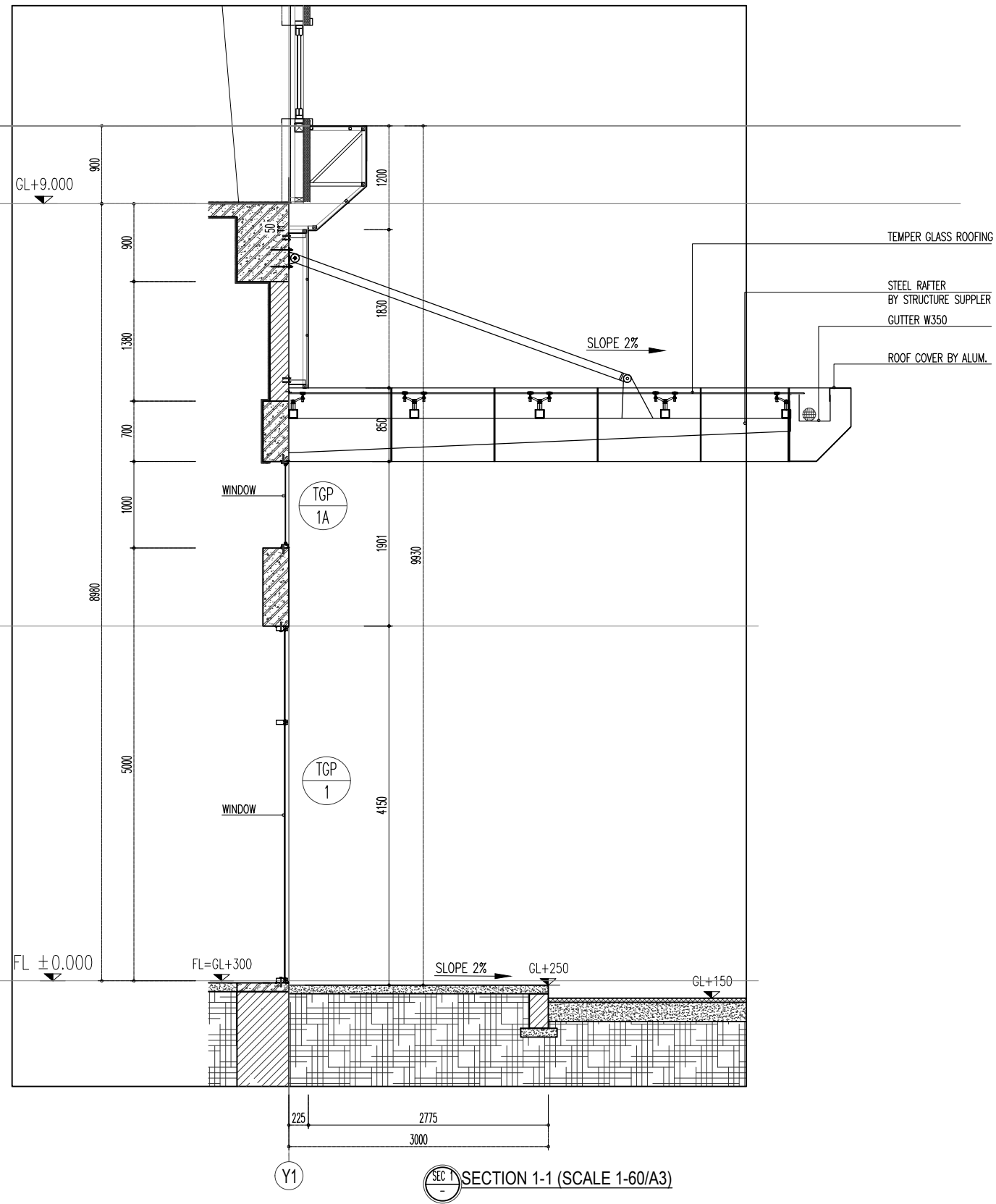

AW 2 ALUM. PUSH WINDOW, 1000X1000 (WXH) (AVOID 1090X1090)

TGW 2A TEMPER GLASS PUSH WINDOW, 3600X2600 (WXH) (AVOID 3690X2690)

TGW 2B TEMPER GLASS PUSH WINDOW, 3120X2600 (WXH) (AVOID 3210X2690)

TGW 3 TEMPER GLASS PUSH WINDOW, 8370X2600 (WXH) (AVOID 8460X2690)

TGD 1 TEMPER GLASS PARTITION, 8530X4060 (WXH) INCLUDE TEMPER GLASS DOOR 3600X2400 (WXH)

TGP 1 TEMPER GLASS PARTITION, 4510X4060 (WXH)

TGP 1A TEMPER GLASS PARTITION, 4510X920 (WXH)

TGP 2 TEMPER GLASS PARTITION, 8530X920 (WXH)

TGW 4 TEMPER GLASS PUSH WINDOW, 8000X2600 (WXH) (AVOID 8090X2690)

SD 2 STEEL DOUBLE SWING DOOR, 2000X2200 (WXH) (AVOID 2090X2290)

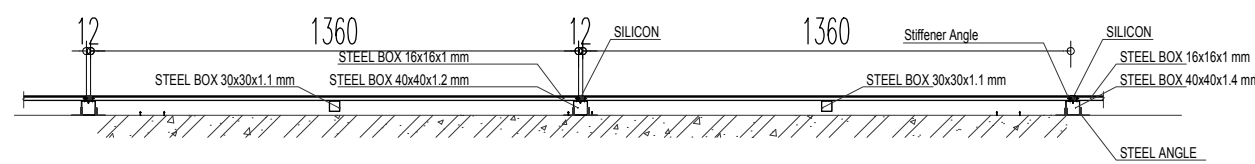
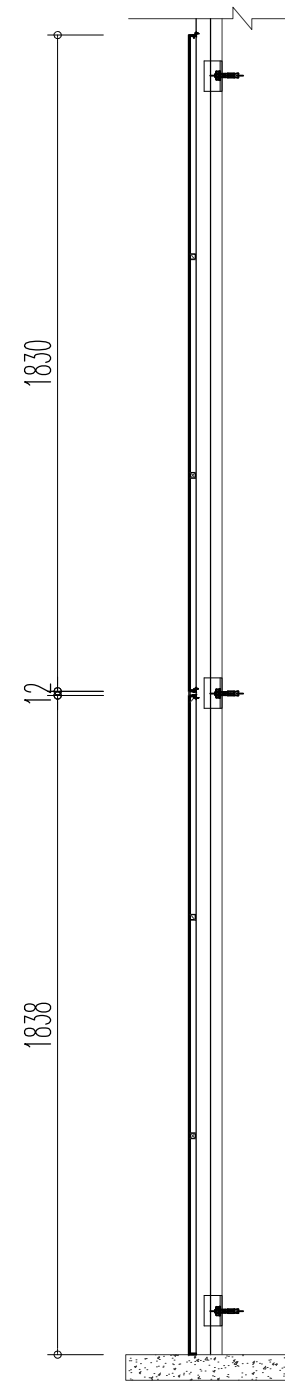
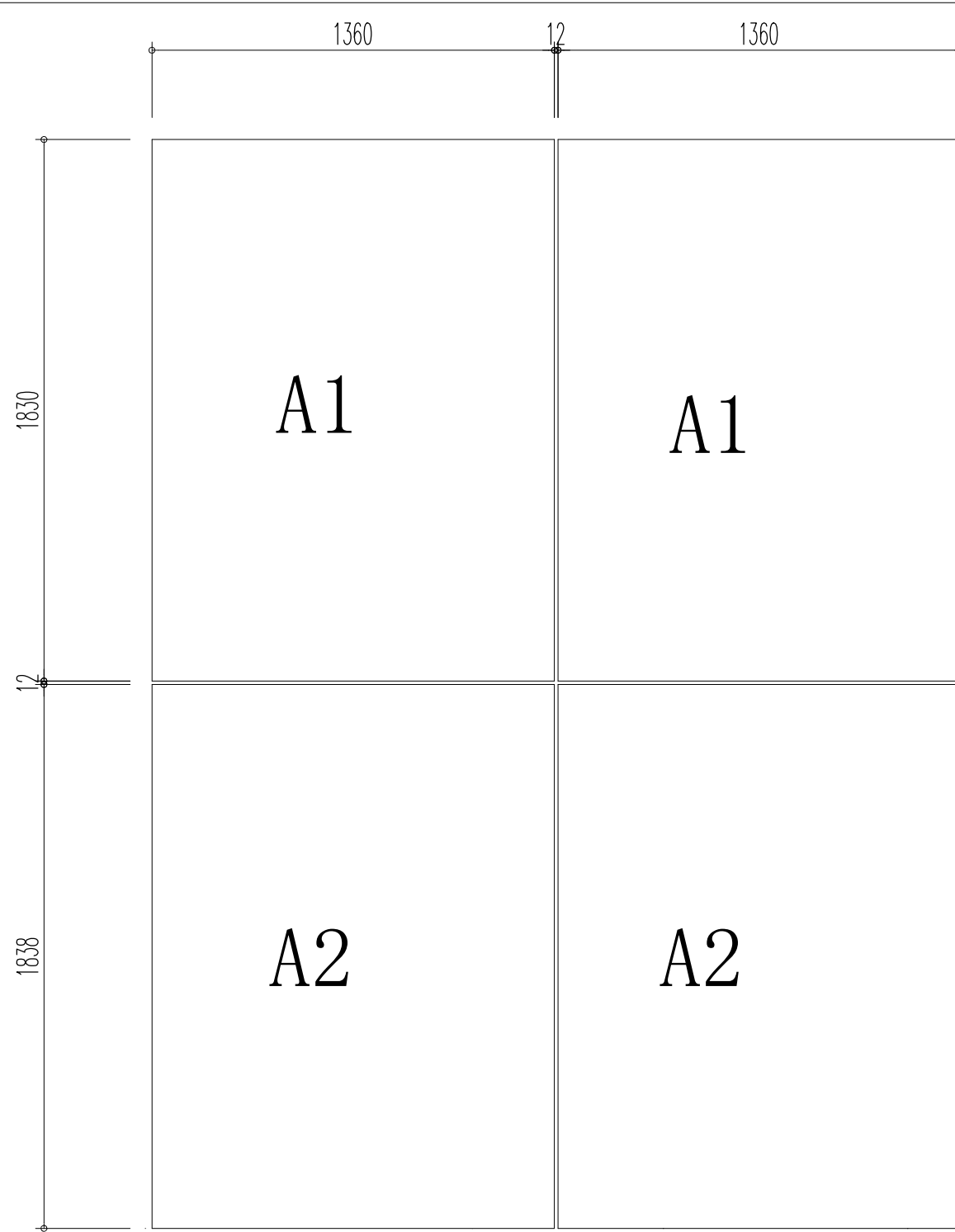

FACADE INSTALLATION (SCALE 1-20/A2)

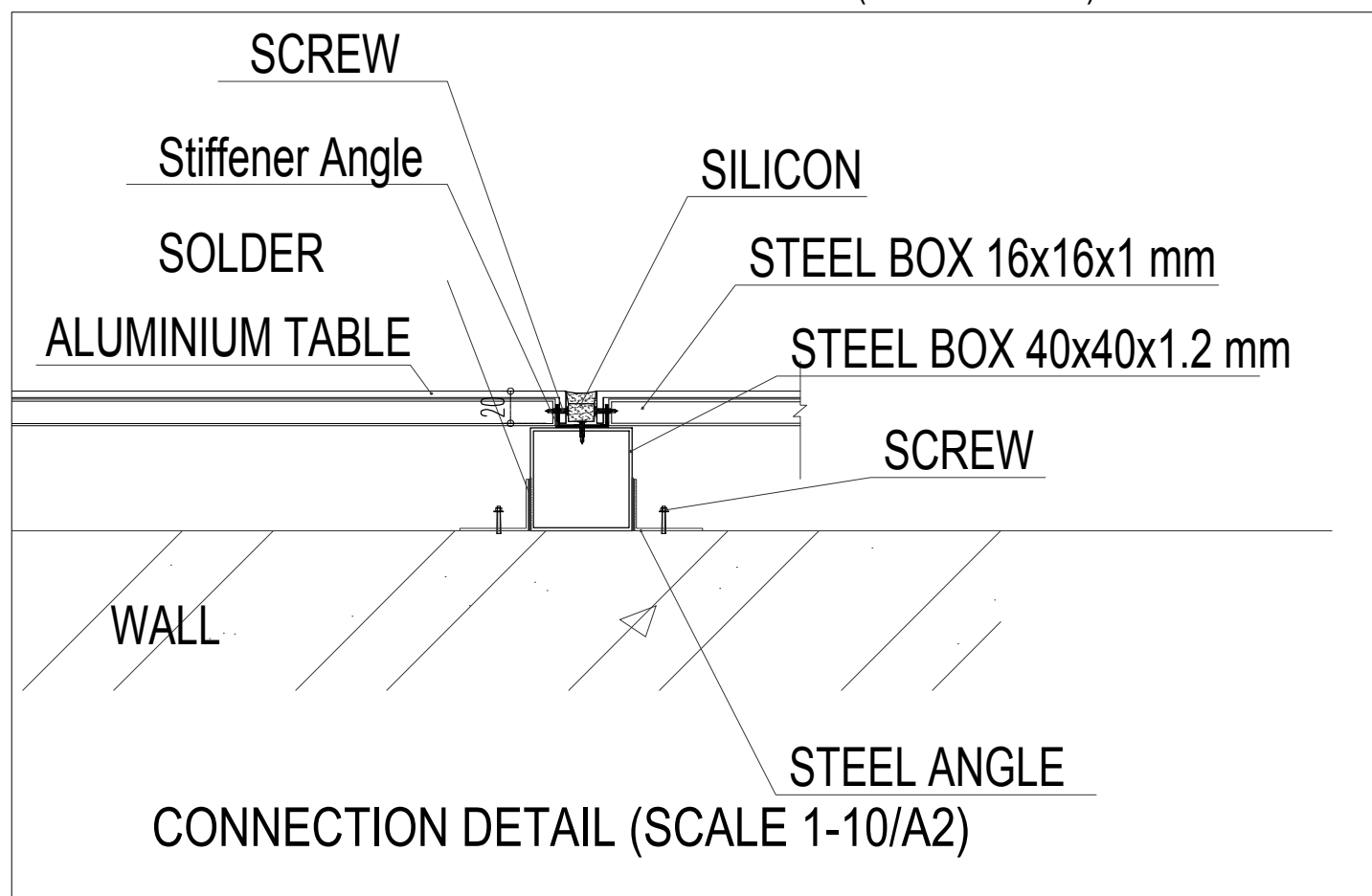

CONNECTION DETAIL (SCALE 1-10/A2)



PICTURE SAMPLE

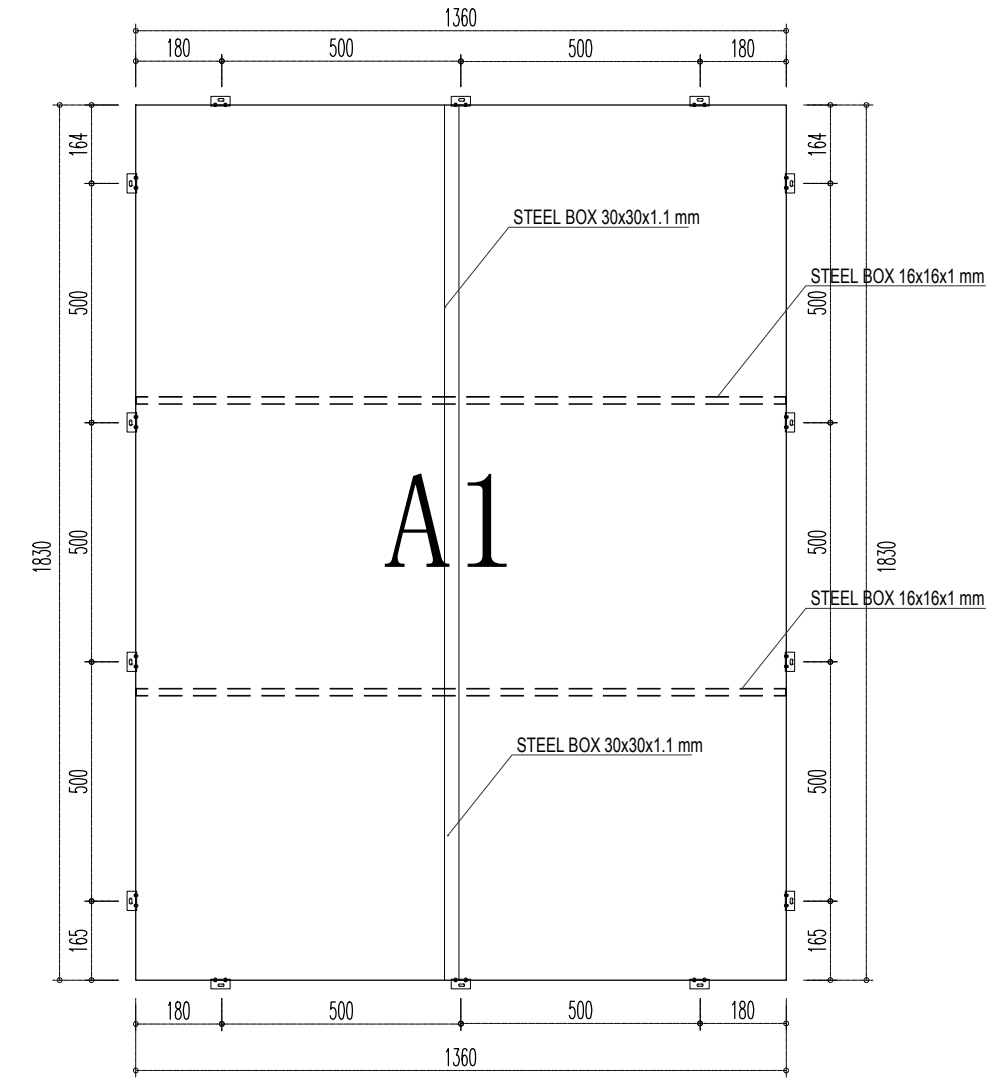
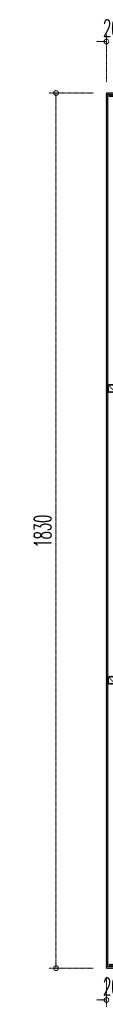

ALUMINIUM TABLE (SCALE 1-10/A2)

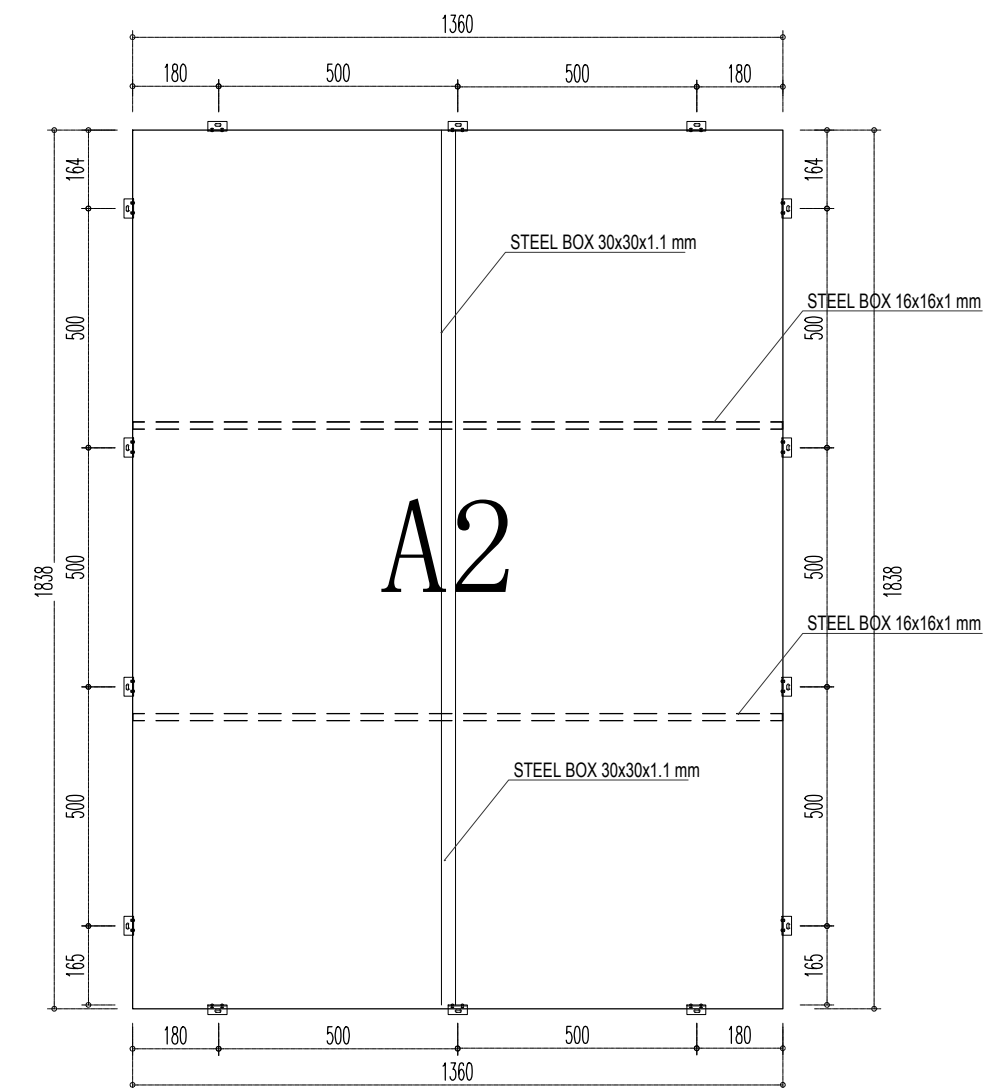

ALUMINIUM TABLE (SCALE 1-10/A2)

