



PRANCE®

柏尔斯建材有限公司
PRANCE BUILDING MATERIAL CO.,LTD.

生产中心：佛山市三水区白坭镇“国家火炬计划佛山电子电器产业基地”南区169号
No 169, South Area, Base of Electrical and Electronic Industry (National Torch Program),
BaiNi Town, SanShui Area, Foshan City, Guangdong Province

营销中心：佛山市禅城区季华六路九鼎国际金融中心1区2座1701-1705室
Office Add: Room 1701, 17/F, Tower 2, District 1, Worldwide Complex, Jihua 6th Road,
Chancheng Foshan, Guangdong, China.

电话 Tel: +86-757-83138155 传真 Fax: +86-757-83139722

邮箱 E-Mail: info@prancebuilding.com

网址 Website: http://prancebuilding.com



PRANCE®
柏尔斯



Door And Window System
门窗系统

ABOUT PRANCE®

PRANCE® is specialized in the production and marketing of building material for 20 years.

PRANCE



Service Process



CONTENTS

WELCOME PRANCE®

50 casement door	01-08
70 casement door	09-18
L85 sliding door	19-26
88A sliding door	27-40
135 balcony door	41-48
46 floor spring door	49-54
50 casement window	57-72
70 casement window	73-82
70 double hung window	83-86
80B sliding window	87-96
L85 sliding window	97-104
88C sliding window	105-116
815 fixed window	117-124
handrail	125-130
blinds	131-132

Quality Control





01

PRODUCT INSTRUCTION

Model: 50 casement door
Surface Treatment: PVDF Coating; Powder Coating; Anodized; Electrophoretic Coating
Profile Thickness: Window: 1.4mm; Door: 2.0mm
Material of Profile: 6063/T5, 6063/T6
Glass Selection: Tempered Glass/Resective Coated Glass(5、6、8、10), Tempered Insulated Glass Units(5+9A+5、6+9A+6)
Hardware Selection: Chinese and German hardware are available(Kin Long、HeHe、Roto)
Applicable Range: Office Buildings, Residential, Villas, Apartments, Schools, Hospitals and other properties of the building envelope system

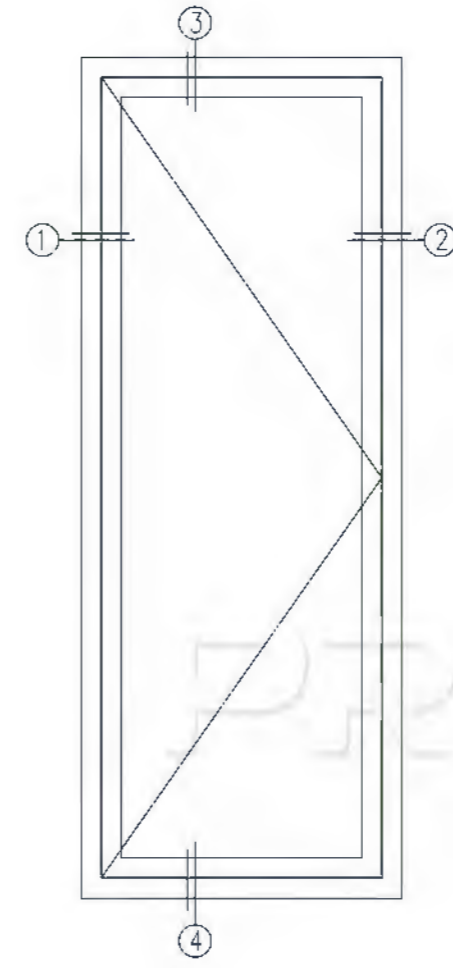

02

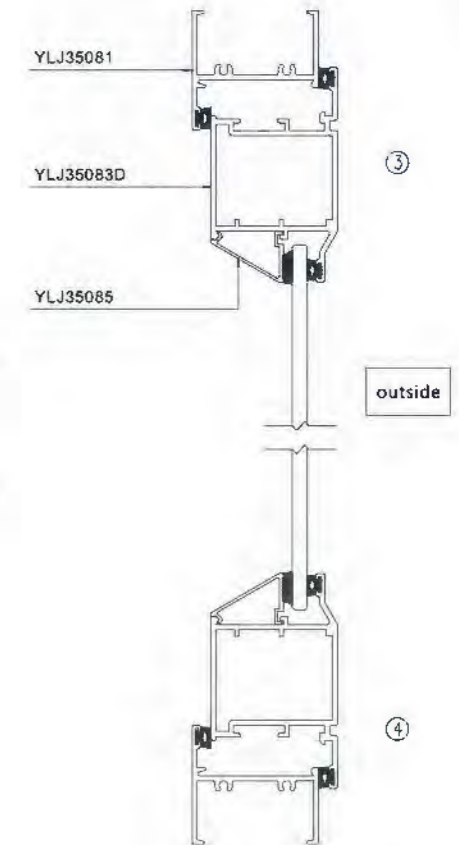
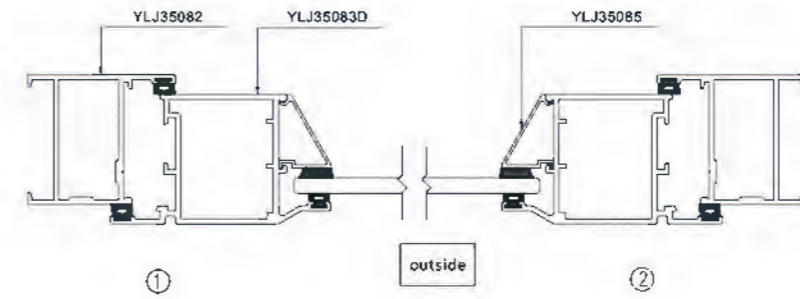

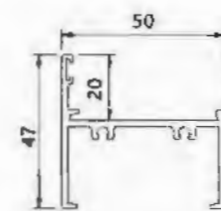
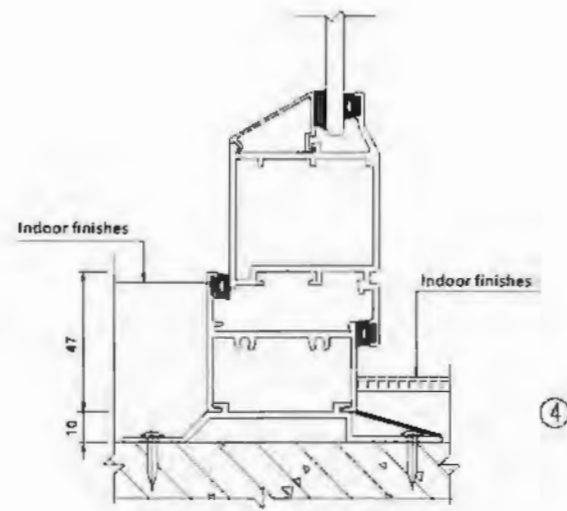
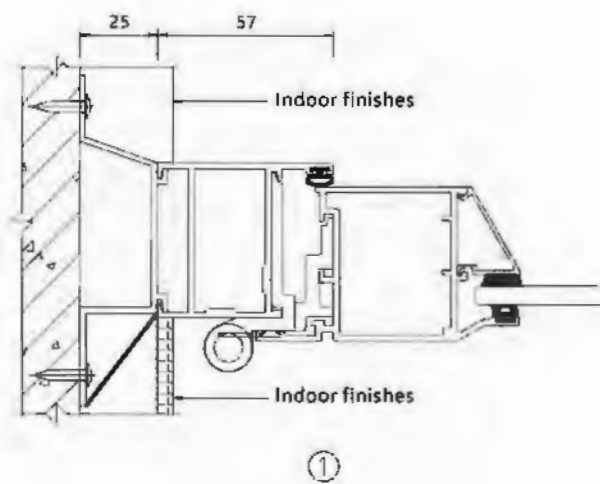
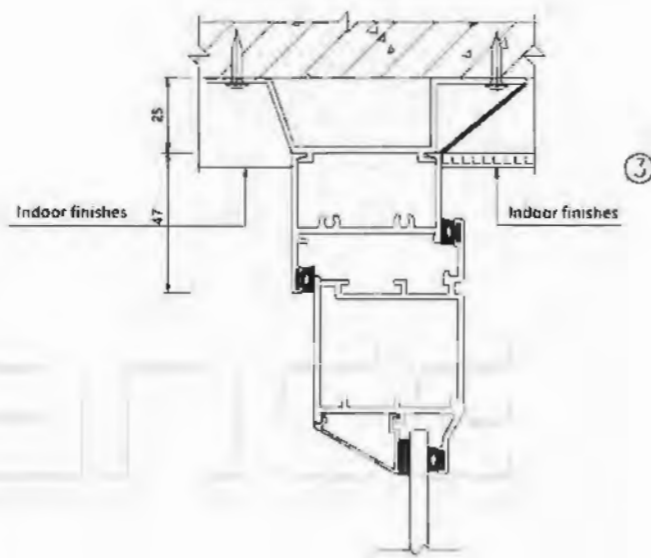
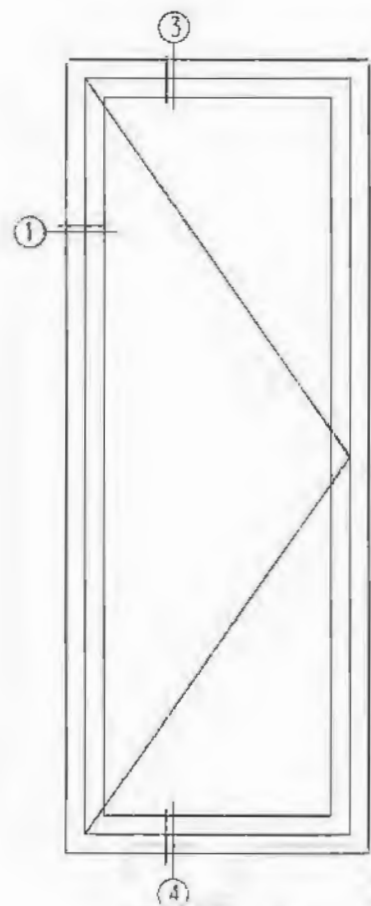

Horizontal Frame YLJ35081
T : 1.9mm 0.785kg/m

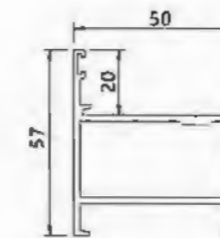

Vertical Frame YLJ35082
T : 1.9mm 1.089kg/m

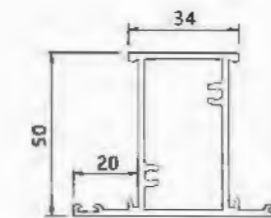

Frame Mullion YLJ35083
T : 2.0mm 1.411kg/m

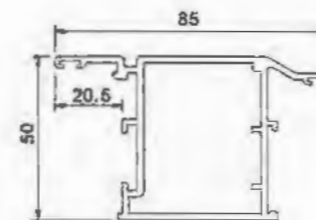

Door Leaf YLJ35083D
T : 2.0mm 1.42kg/m

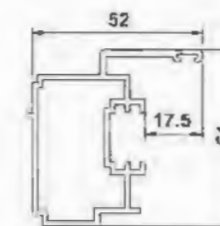

Sash Close-up YLJ35108
T : 1.6mm 0.998kg/m

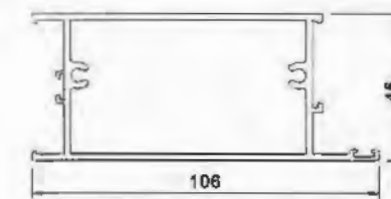

Sash Bottom YLJ35105
T : 2.0mm 1.697kg/m

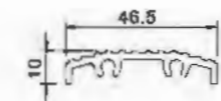

Sash Bottom YLJ35106
T : 2.0mm 0.453kg/m

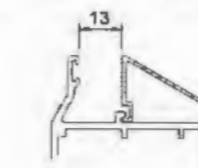

Frame Glass Bead YLJ35085
T : 1.0mm 0.178kg/m

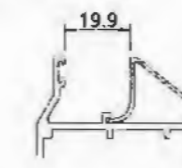

Sash Glass Bead YLJ35085A
T : 1.0mm 0.167kg/m

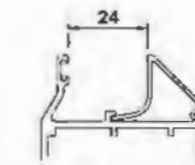

Sash Glass Bead YLJ35104B
T : 1.1mm 0.174kg/m

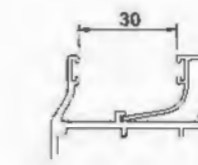

Sash Glass Bead YLJ35104A
T : 1.1mm 0.219kg/m

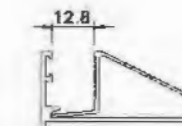

Frame Glass Bead YLJ25015G
T : 1.0mm 0.19kg/m

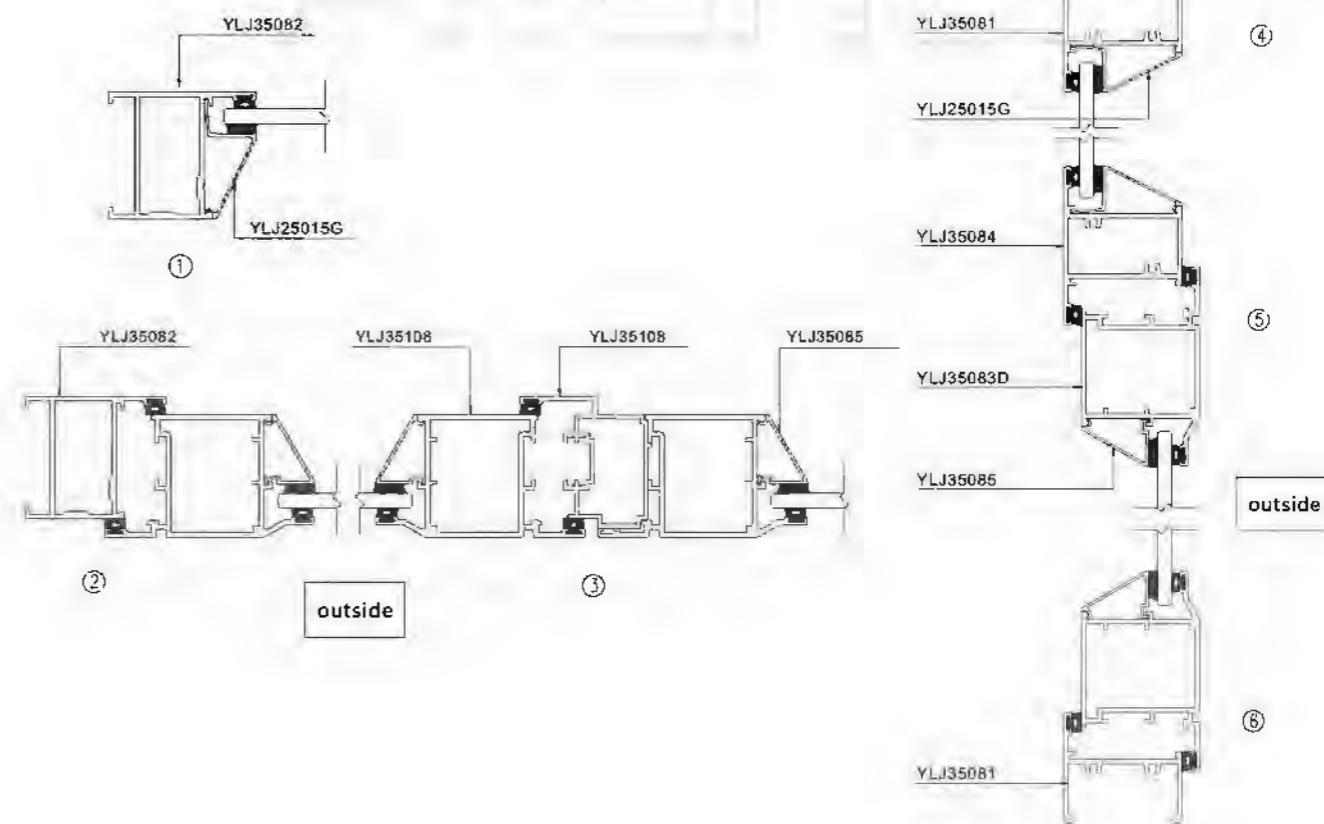
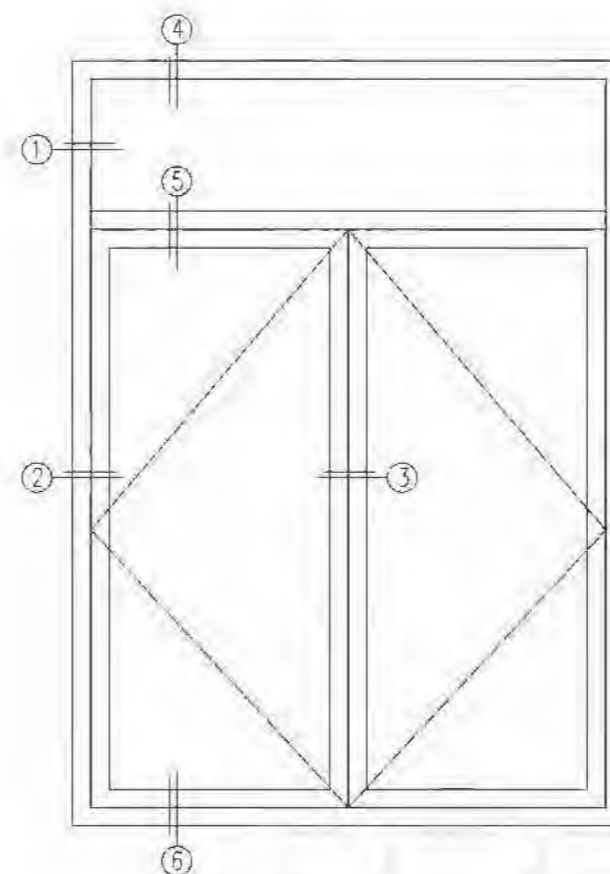
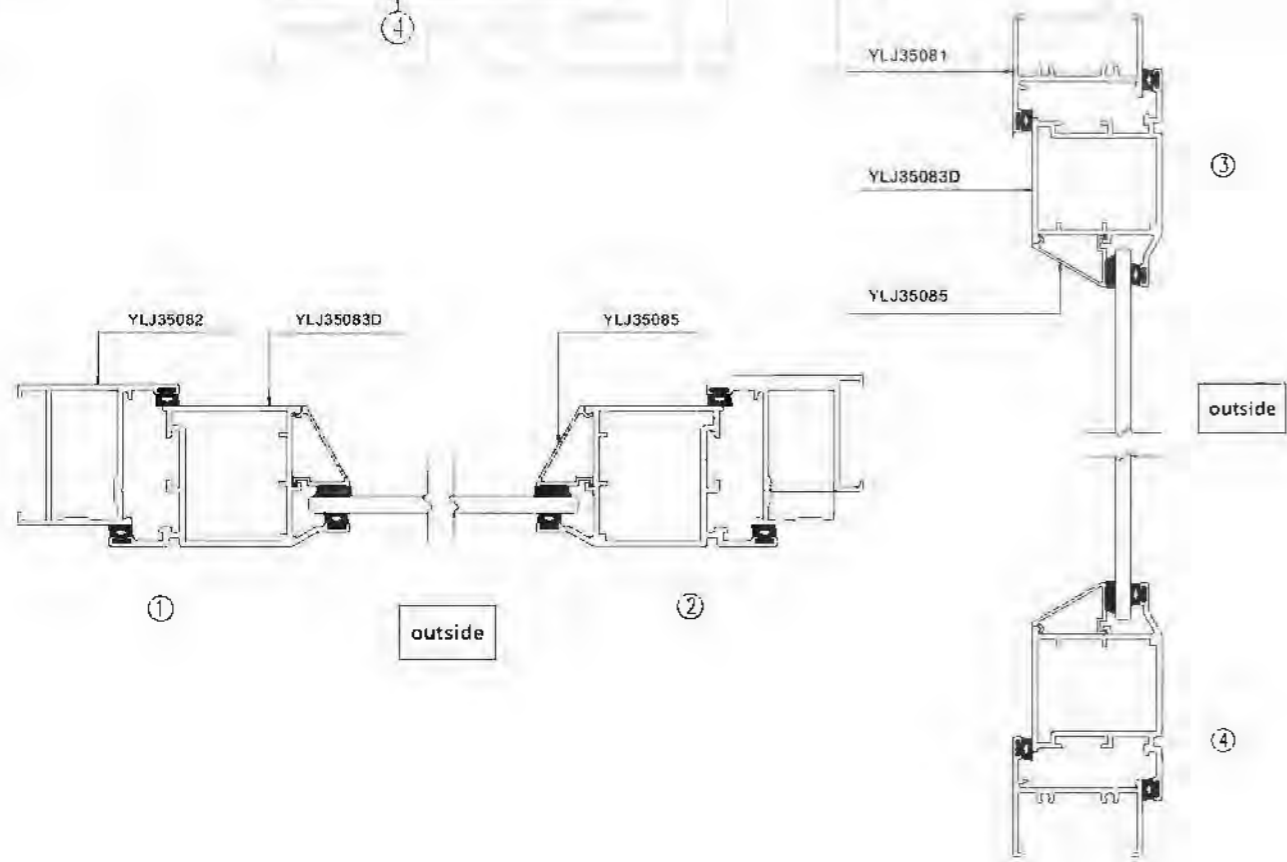
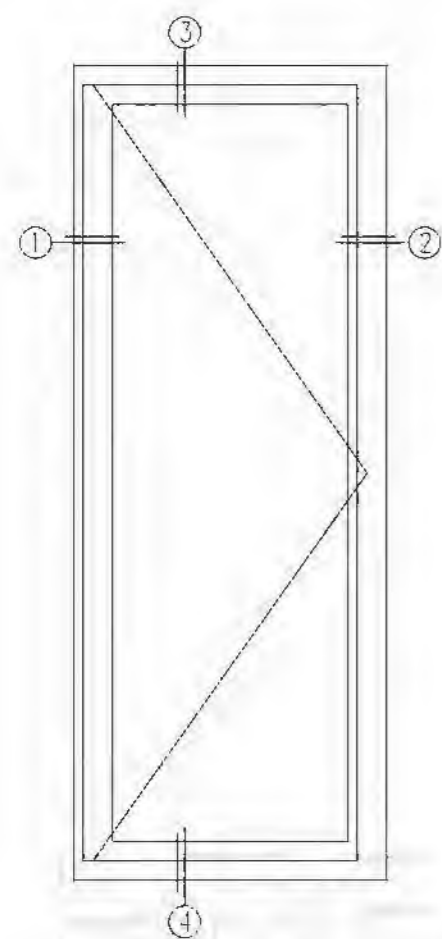



SHOWING



The advantage of Casement Door is high sealing performance, overall sense of permeability, good sense of space, to ensure the sound insulation.

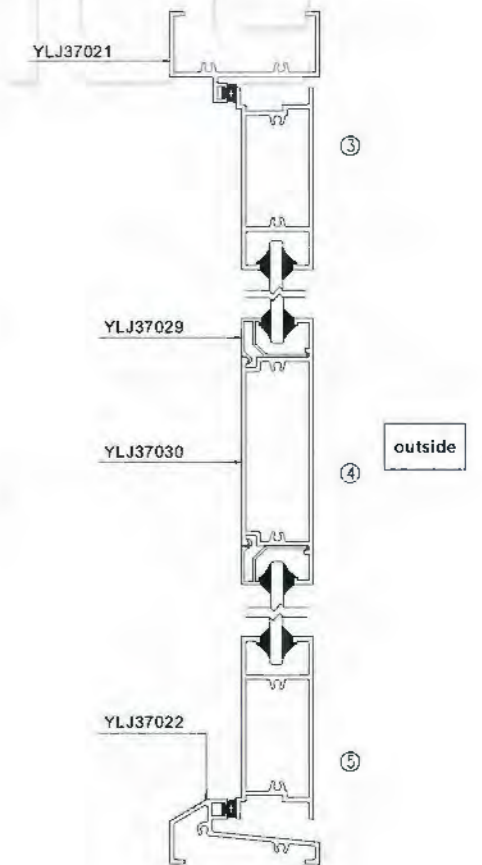
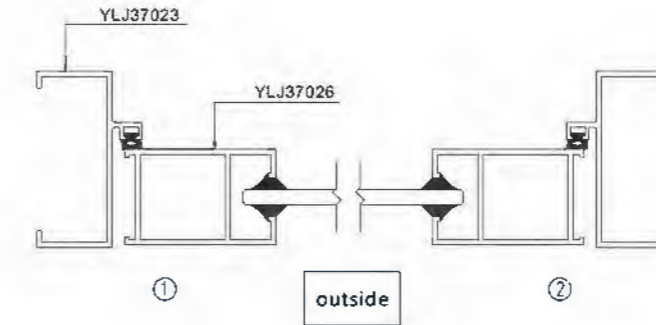
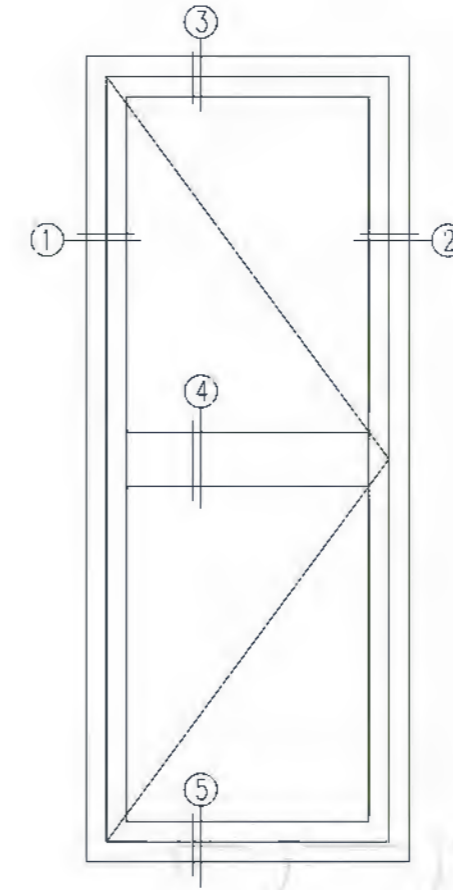

PRODUCT INSTRUCTION

Model: 70 casement door

Surface Treatment: PVDF Coating; Powder Coating; Anodized; Electrophoretic Coating

Profile Thickness: Window: 1.4mm; Door: 2.0mm

Material of Profile: 6063/T5、6063/T6

Glass Selection: Tempered Glass/Resective Coated Glass(5、6、8、10), Tempered Insulated Glass Units(5+9A+5、6+9A+6)

Hardware Selection: Chinese and German hardware are available(Kin Long、HeHe、Roto)

Applicable Range: Office Buildings, Residential, Villas, Apartments, Schools, Hospitals and other properties of the building envelope system

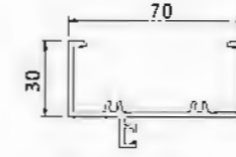
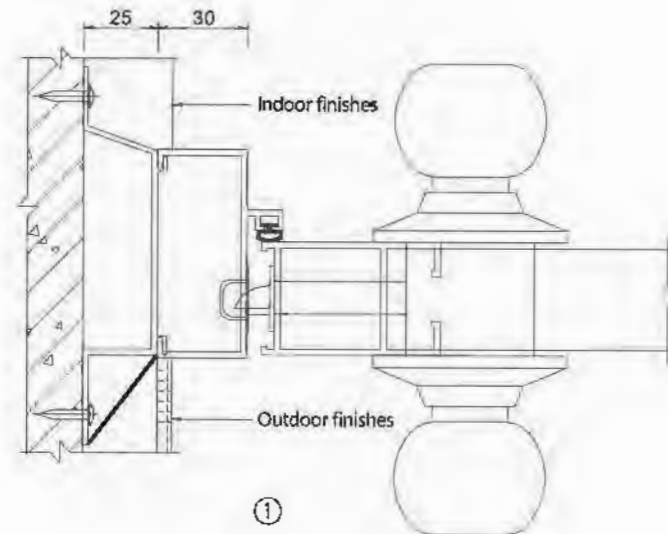
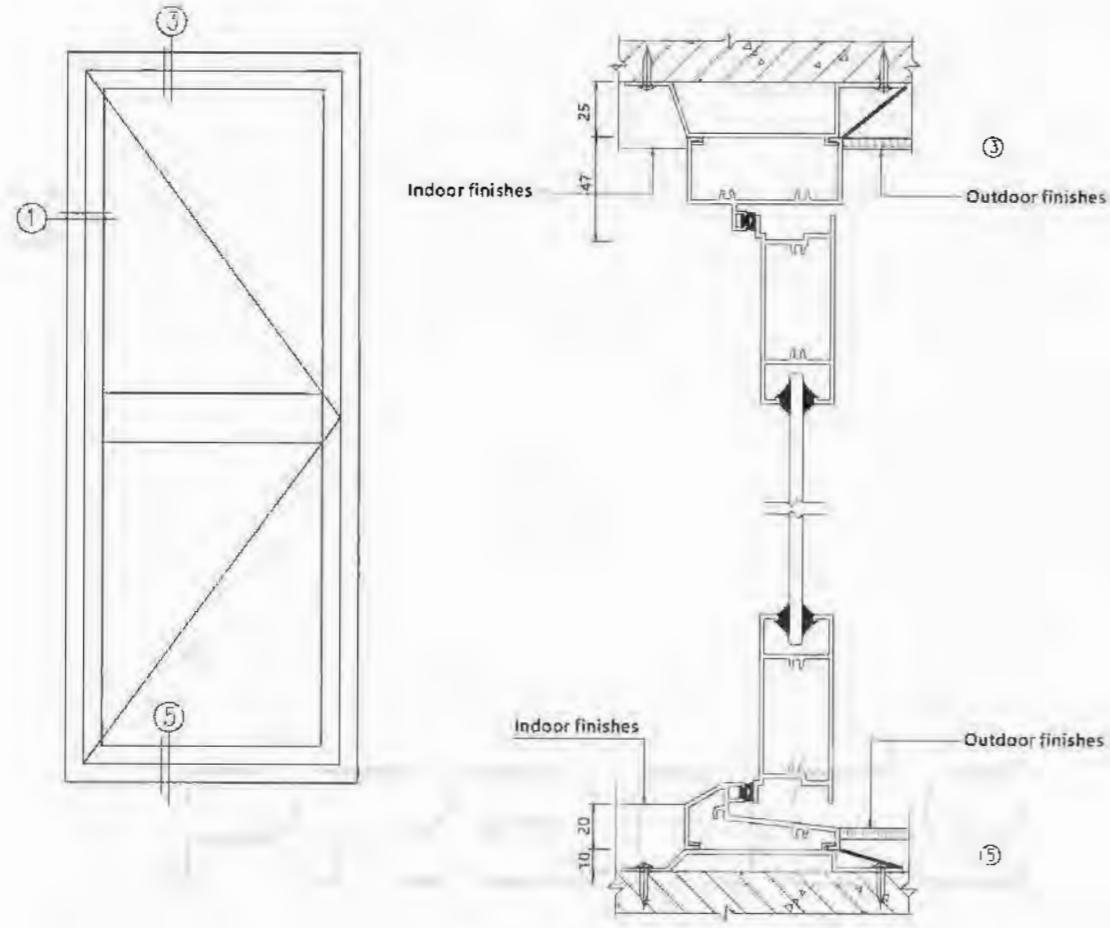

Above YLJ37021
T : 2.0mm 0.943kg/m
YLJ37021A
T=1.4mm 0.726kg/m

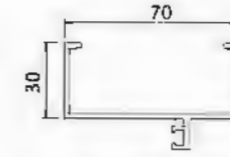

Frame Edge YLJ37023
T : 2.0mm 0.85kg/m
YLJ37023A
T=1.4mm 0.633kg/m

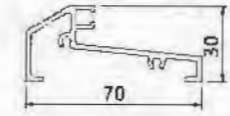

Threshold Material YLJ37022H
T : 2.0mm 0.828kg/m
YLJ37022
T=1.4mm 0.648kg/m

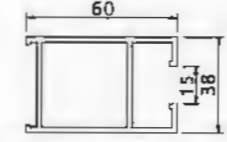

Vertical Frame YLJ37026
T : 2.0mm 1.147kg/m
YLJ37026C
T=1.6mm 0.939kg/m

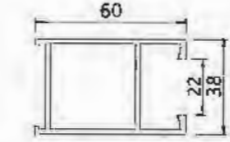

Vertical Frame YLJ37026ZK
T : 2.0mm 1.113kg/m

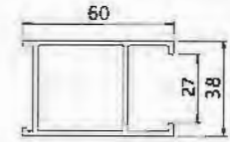

Vertical Frame YLJ37026AZK
T : 2.0mm 1.074kg/m

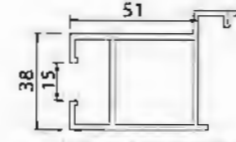

Double Sash Middle Frame YLJ37027
T : 2.0mm 1.261kg/m
YLJ37027C
T=1.6mm 1.031kg/m

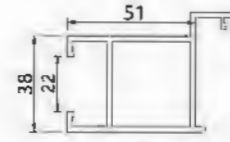

Double Sash Middle Frame YLJ37027ZK
T : 2.0mm 1.223kg/m

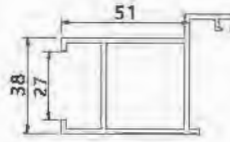

Double Sash Middle Frame YLJ37027AZK
T : 2.0mm 1.184kg/m

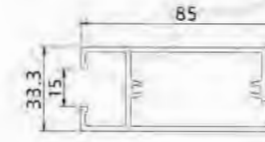

Door Leaf YLJ37015
T : 2.0mm 1.457kg/m
YLJ37015C
T=1.6mm 1.202kg/m

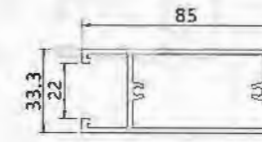

Door Leaf YLJ37015ZK
T : 2.0mm 1.424kg/m

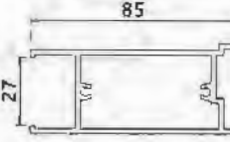

Door Leaf YLJ37015AZK
T : 2.0mm 1.385kg/m

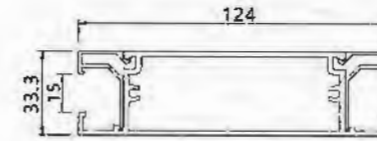

Leaf Cross Bar YLJ37030
T : 2.0mm 1.739kg/m
YLJ37029
T=1.2mm 0.23kg/m

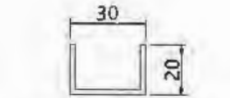

Frame Groove C3020A
T : 1.5mm 1.184kg/m

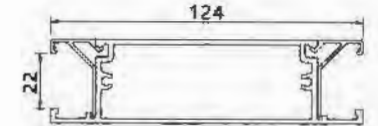

Leaf Cross Bar YLJ37030ZK
T : 2.0mm 1.707kg/m
Glass Bead YLJ37029
T=1.2mm 0.21kg/m

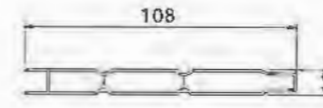

Panel YLJ83009
T : 1.0mm 0.668kg/m
YLJ83009P
T=0.8mm 0.578kg/m



Blinds YLJ84002
T : 1.2mm 0.366kg/m

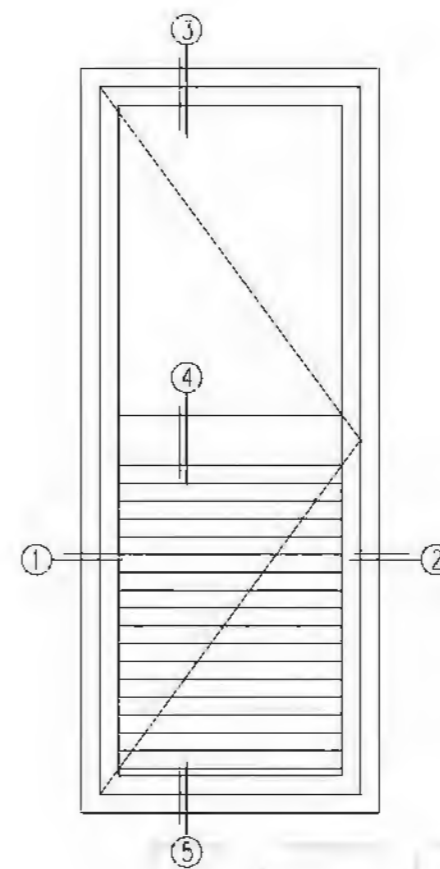
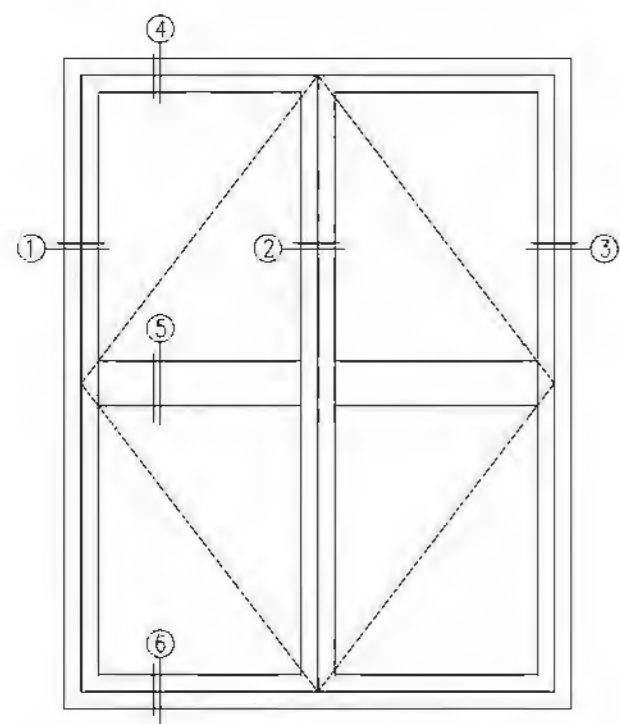

13

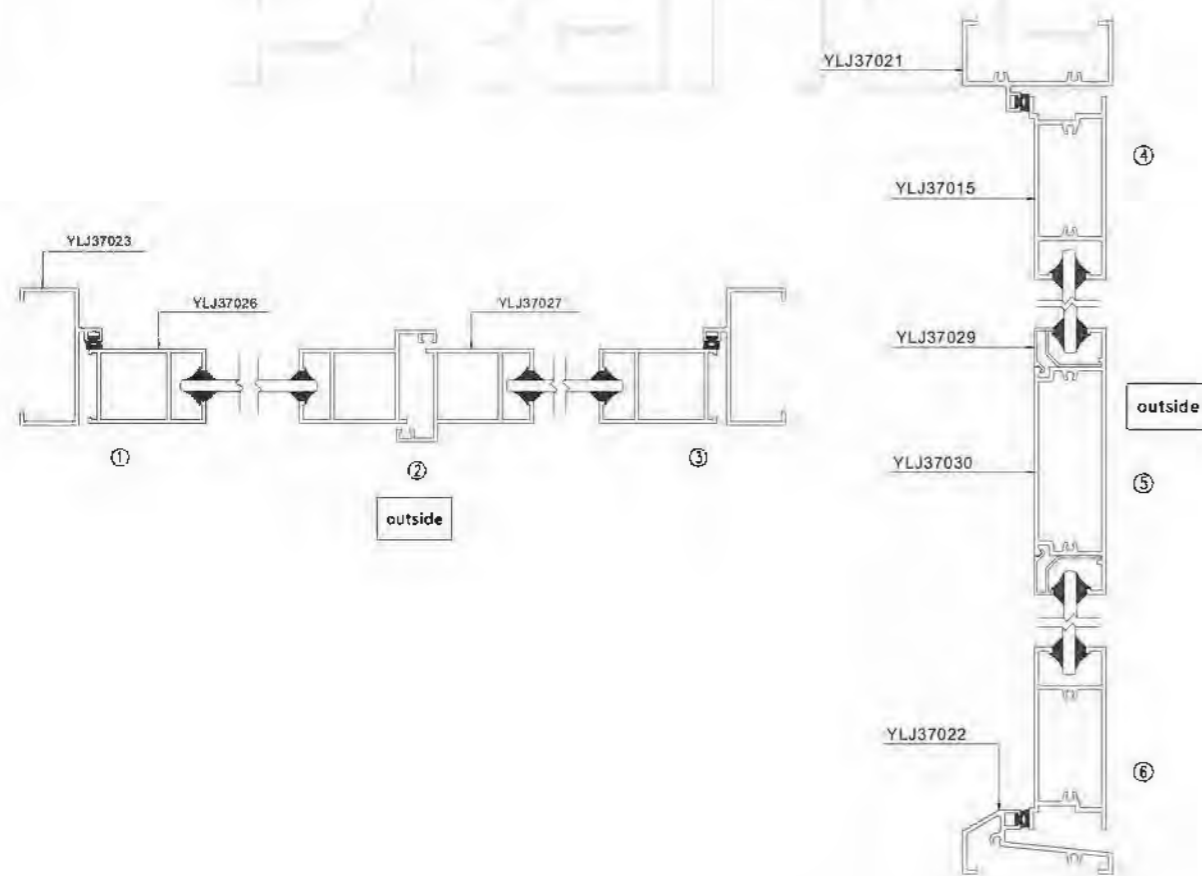

14

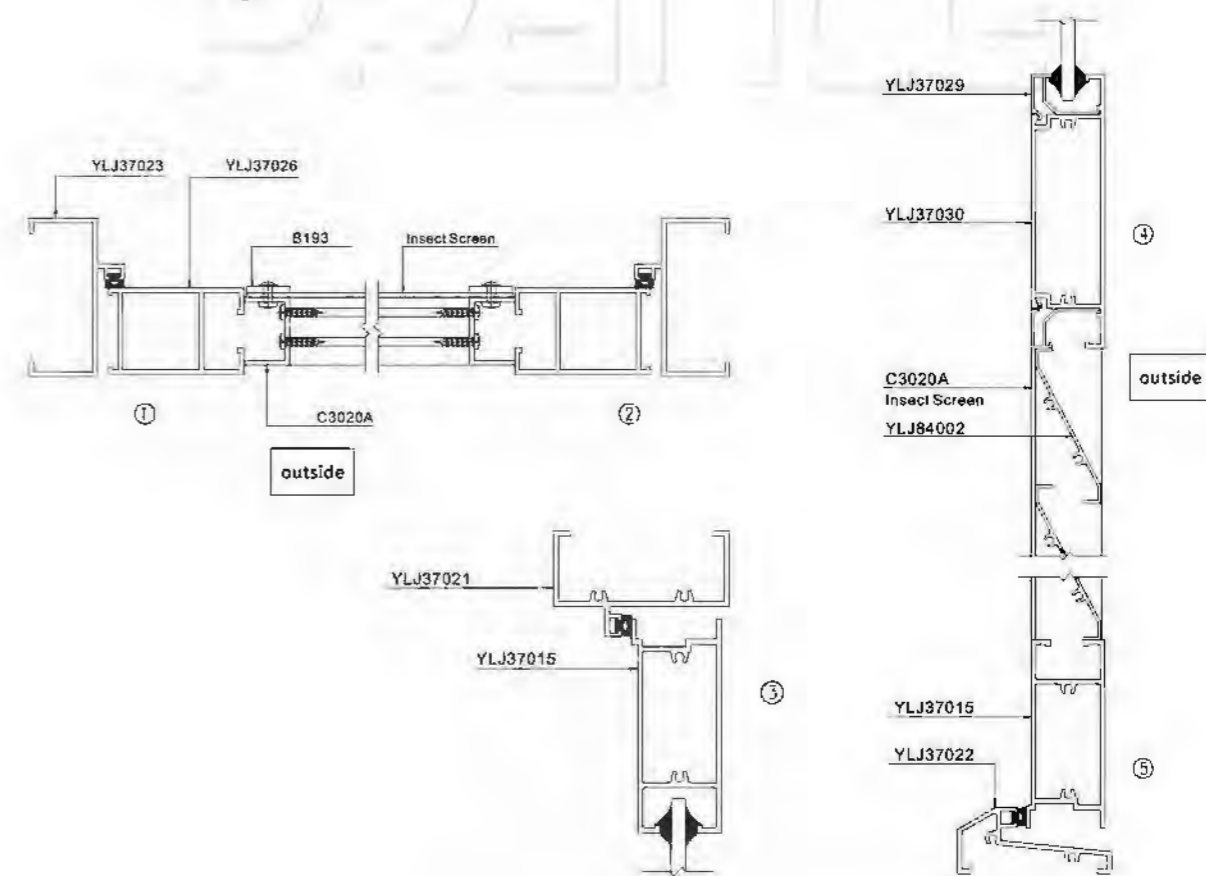

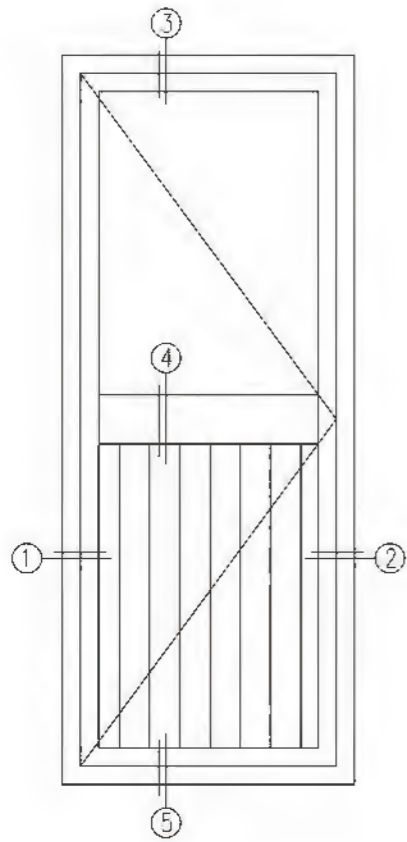

15

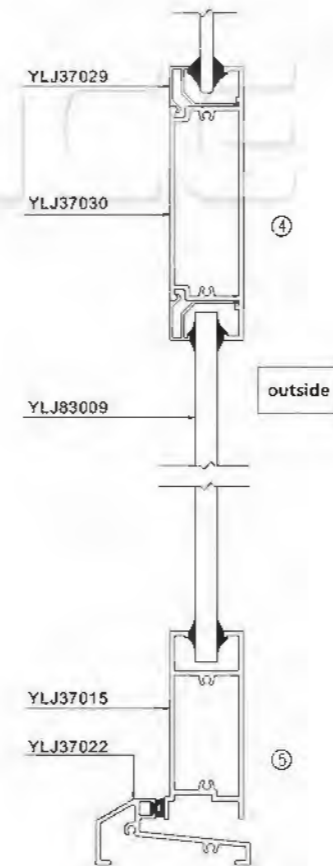
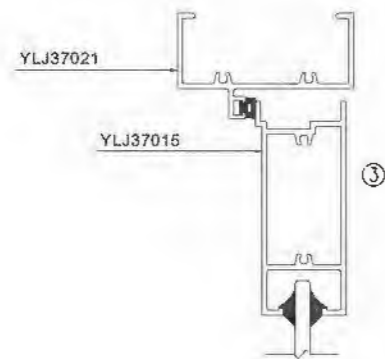
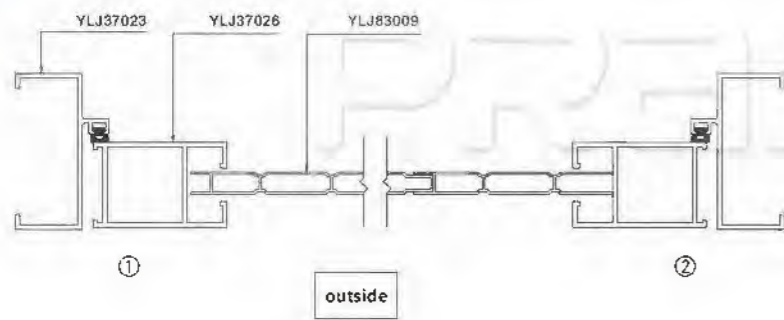

Installation is easy to clean, you can wash with water directly;
the door profile is waterproof, anti-corrosion, anti-deformation.



The addition of stylish elements gives the door a fashion and simple appearance.



SHOWING



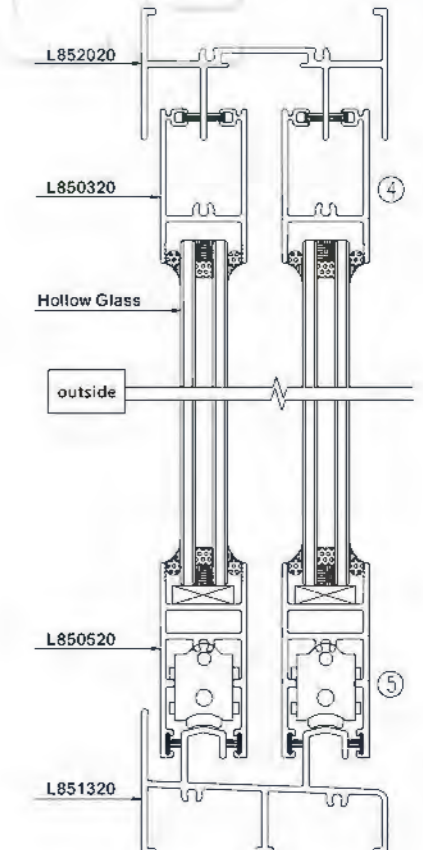
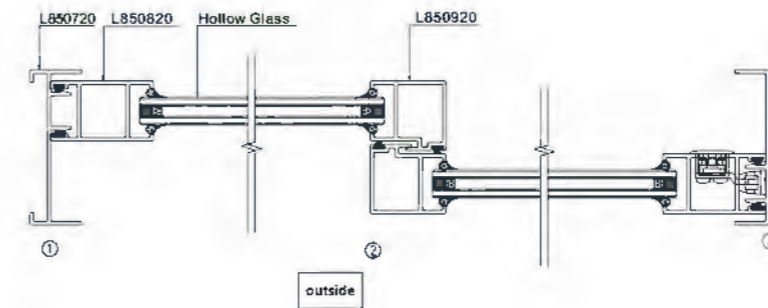
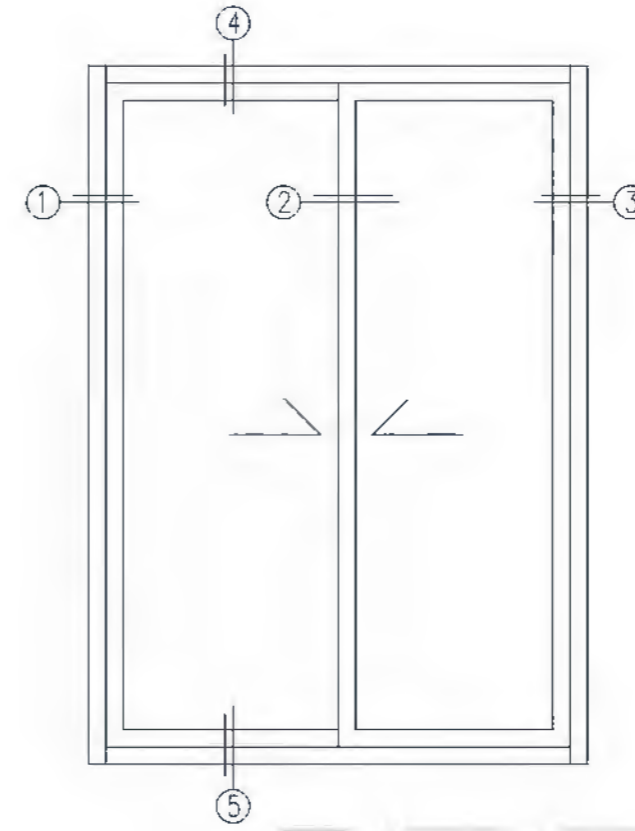

PRODUCT INSTRUCTION

Model: L85 sliding door
Surface Treatment: PVDF Coating; Powder Coating; Anodized; Electrophoretic Coating
Profile Thickness: Window: 1.4mm; Door: 2.0mm
Material of Profile: 6063/T5、6063/T6
Glass Selection: Tempered Glass/Resective Coated Glass(5、6、8、10), Tempered Insulated Glass Units(5+9A+5、6+9A+6)
Hardware Selection: Chinese and German hardware are available(Kin Long、HeHe、Roto)
Applicable Range: Office Buildings, Residential, Villas, Apartments, Schools, Hospitals and other properties of the building envelope system

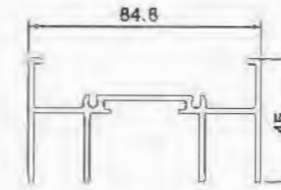
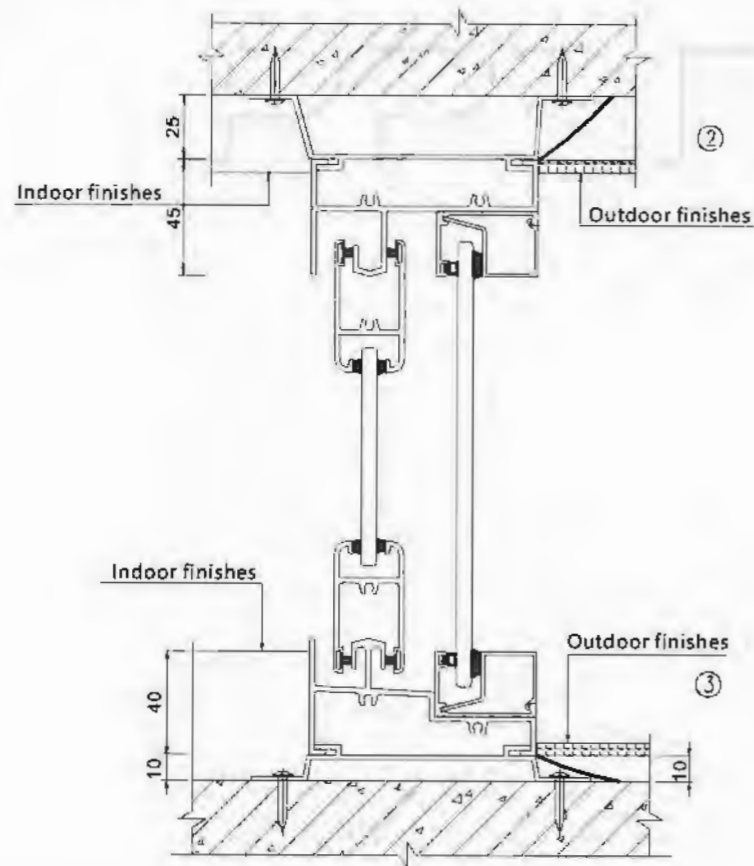
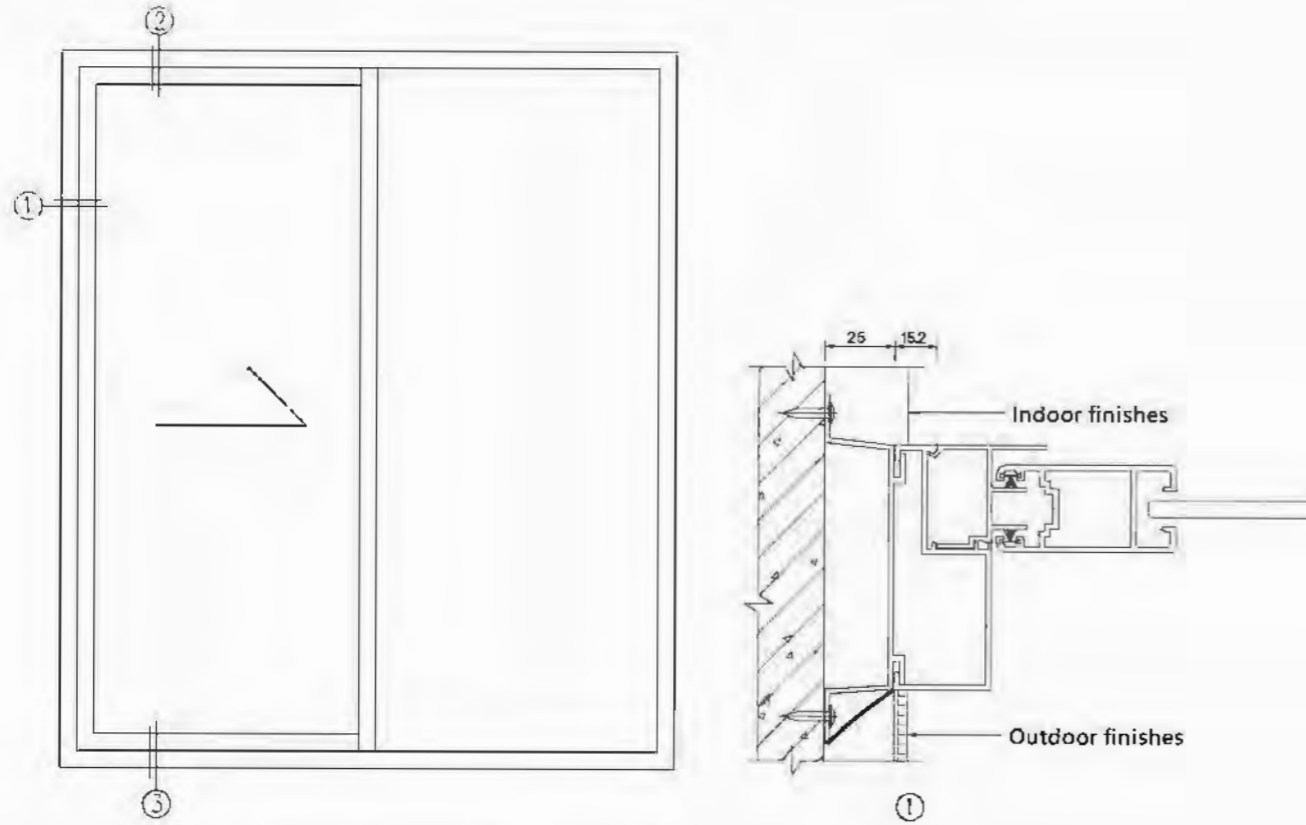

Upper Groove L852020
T=2.0mm 1.369kg/m

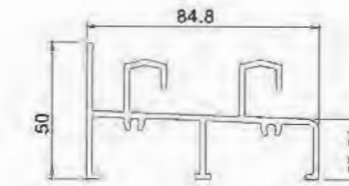

Bottom Groove L851320
T=2.0mm 1.536kg/m

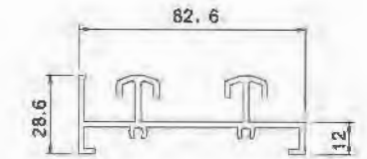

Bottom Groove CG8511F
T=2.0mm 1.209kg/m

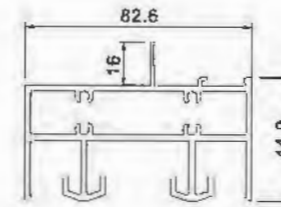

Upper Groove L85A0220
T=2.0mm 2.082kg/m

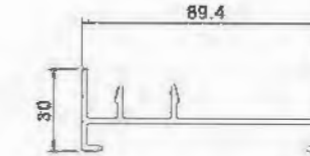

Edge Frame L850720
T=2.0mm 0.990kg/m

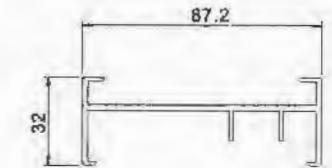

Edge Frame L85A1020
T=2.0mm 0.968kg/m

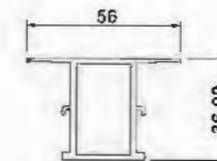

Fixed Middle Mullion L85A1120
T=2.0mm 0.816kg/m

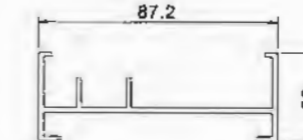

Edge Frame CG8513F
T=2.0mm 0.968kg/m

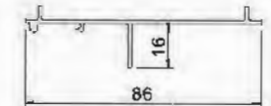

Panel L85A0914
T=1.4mm 0.464kg/m

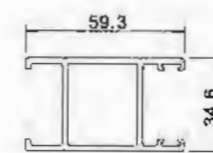

Lighting Frame L850820
T=2.0mm 1.055kg/m

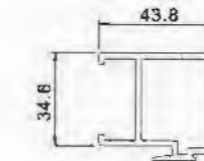

Hook Frame L850920
T=2.0mm 0.942kg/m

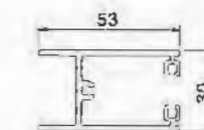

Above L850320
T=2.0mm 0.883kg/m

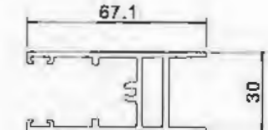

Below L850520
T=2.0mm 1.152kg/m

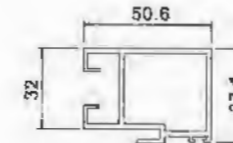

Hook Frame L85A2020
T=2.0mm 1.056kg/m

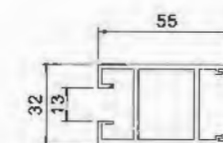

Lighting Frame L85A1920
T=2.0mm 1.015kg/m

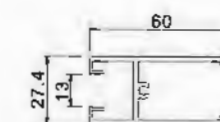

(Below)Above L85A1720
T=2.0mm 0.903kg/m

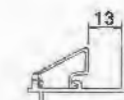

Glass Bead L85A2210
T=1.0mm 0.156kg/m

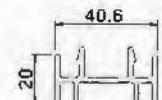

Close-up L851220
T=2.0mm 0.633kg/m

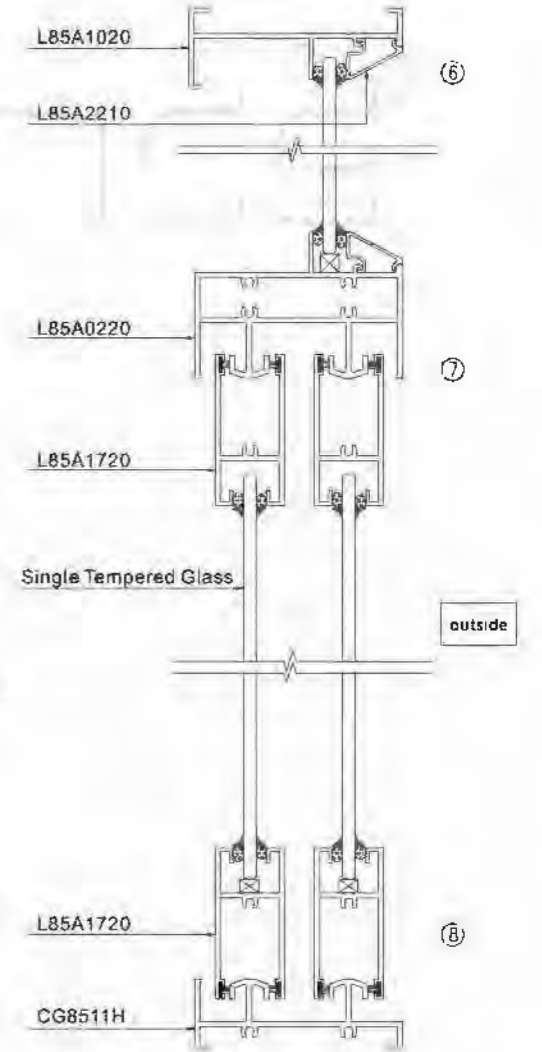
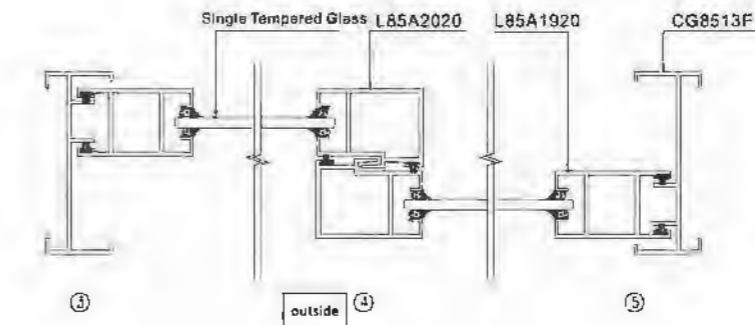
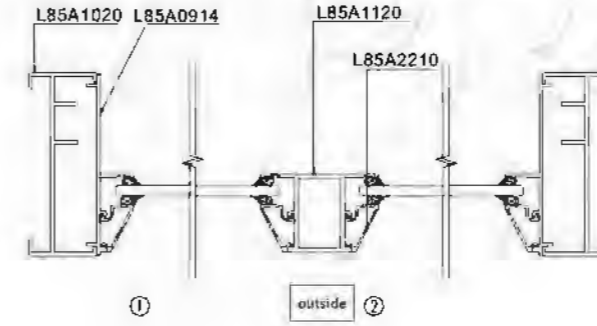
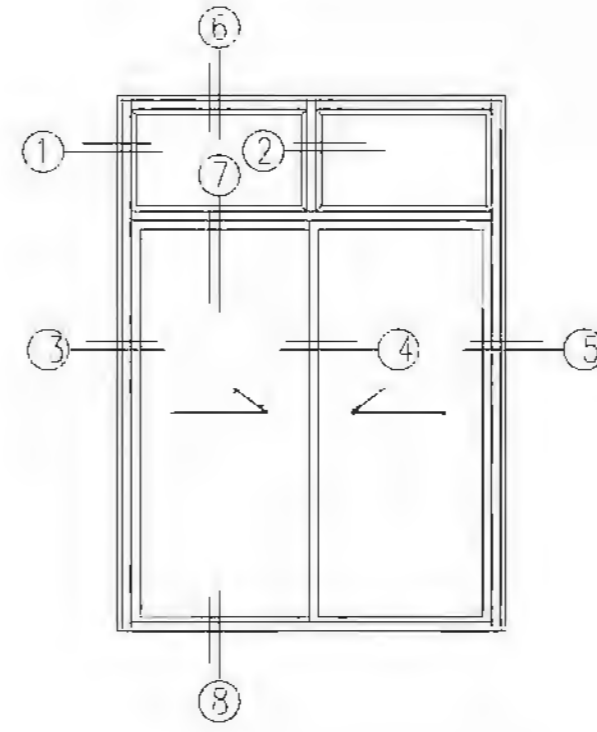
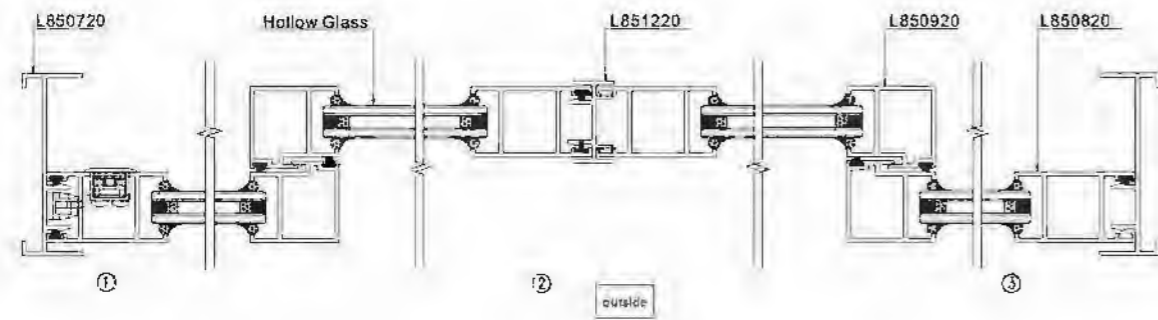
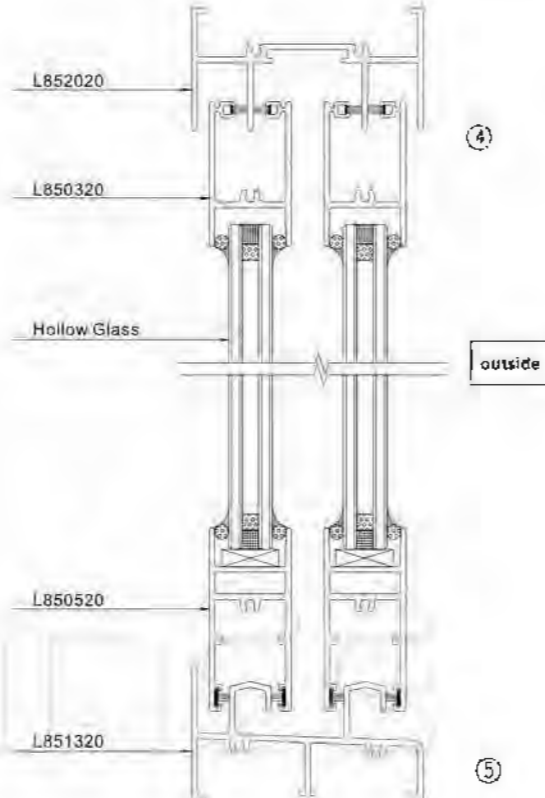
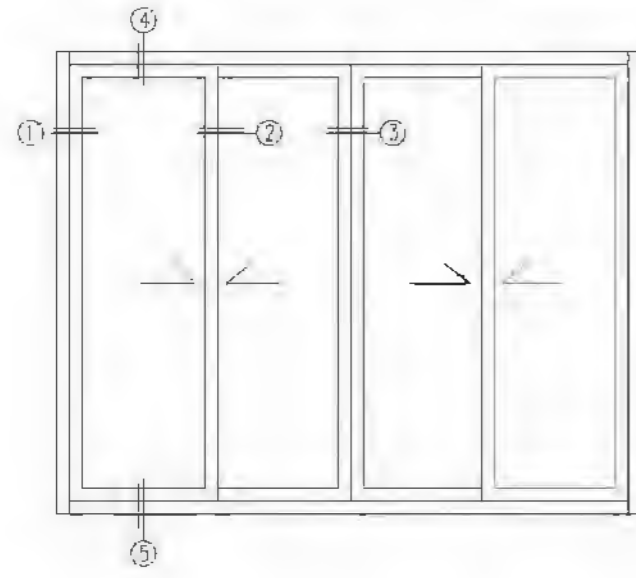



SHOWING



Small size, light-weighted materials, high permeability, can continuously create space divisions, making space to maintain a more fluid, richer level.

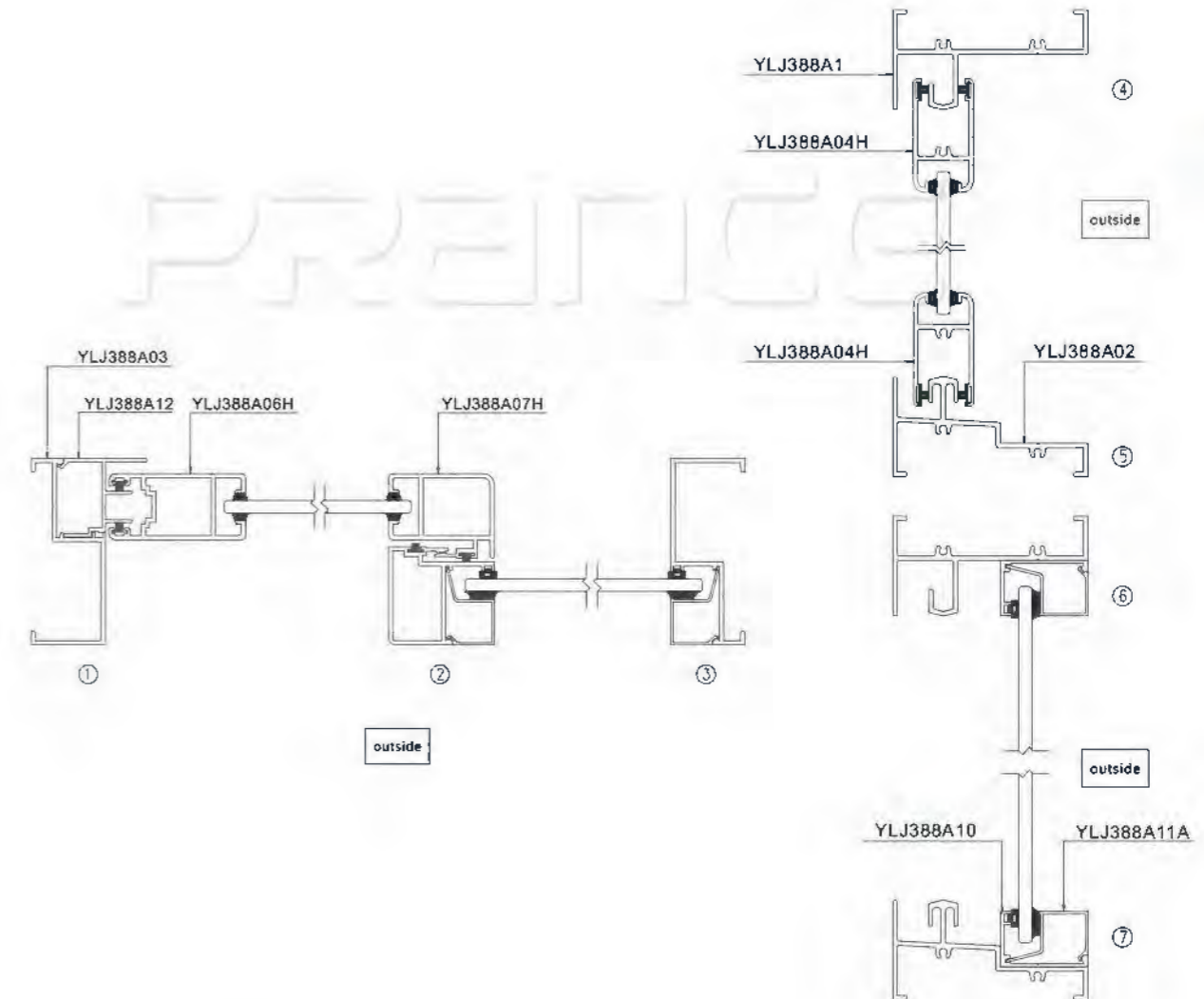
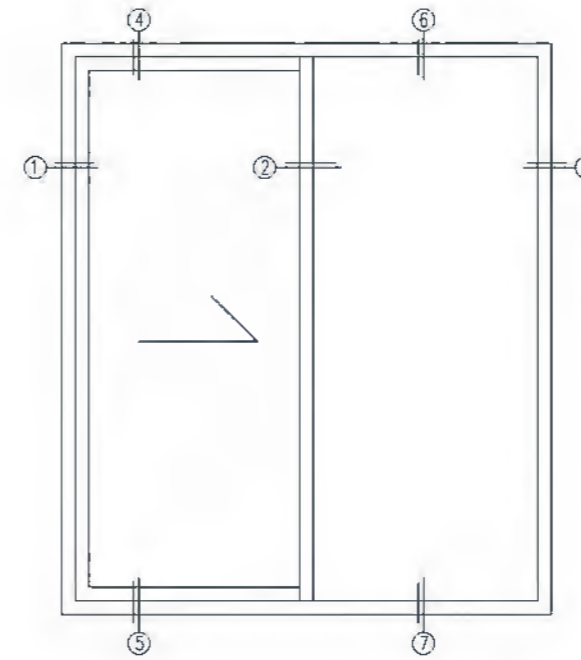

PRODUCT INSTRUCTION

Model: 88A sliding door
Surface Treatment: PVDF Coating; Powder Coating; Anodized; Electrophoretic Coating
Profile Thickness: Window: 1.4mm; Door: 2.0mm
Material of Profile: 6063/T5, 6063/T6
Glass Selection: Tempered Glass/Reflective Coated Glass(5, 6, 8, 10), Tempered Insulated Glass Units(5+9A+5, 6+9A+6)
Hardware Selection: Chinese and German hardware are available(Kin Long, HeHe, Roto)
Applicable Range: Office Buildings, Residential, Villas, Apartments, Schools, Hospitals and other properties of the building envelope system

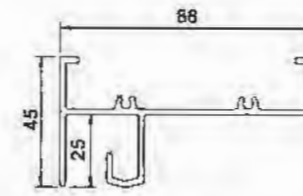
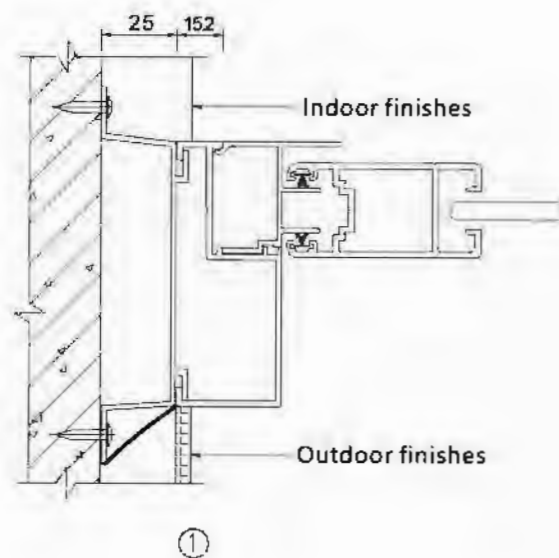
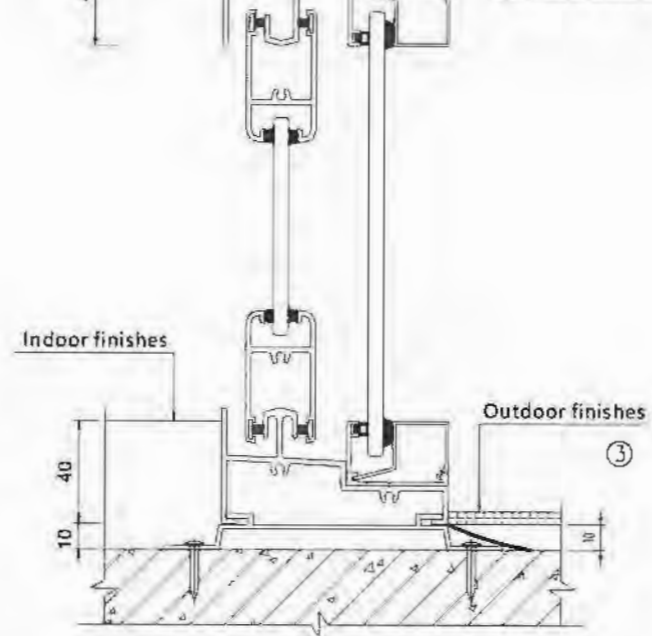
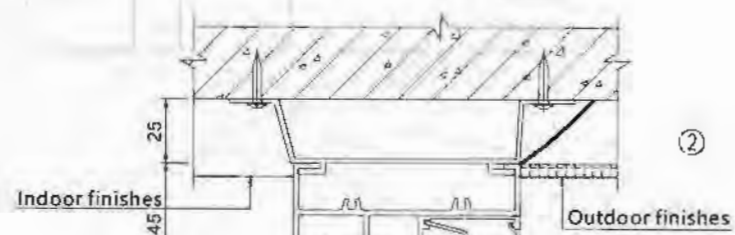
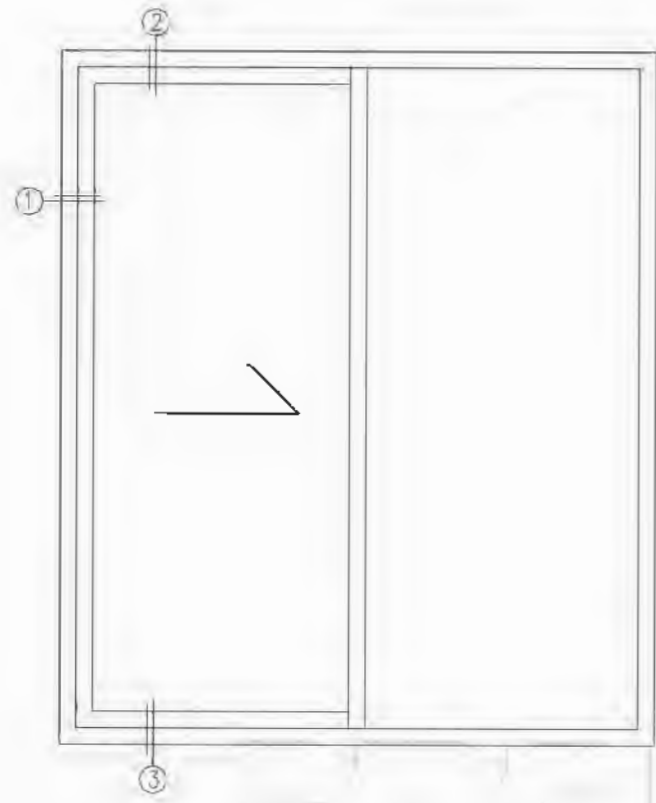

Upper Rail YLJ388A01
T=2.0mm 1.2kg/m

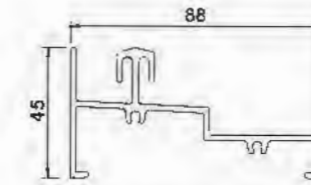

Upper Rail YLJ388A02
T=2.0mm 1.248kg/m

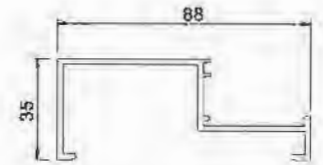

Edge Seal YLJ388A03
T=2.0mm 0.941kg/m

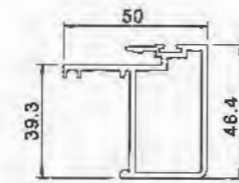

Fixed Hook Frame YLJ388A07A
T=2.0mm 1.005kg/m

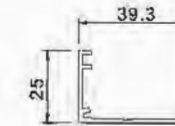

Fixed Pressure Base YLJ388A10
T=1.4mm 0.306kg/m

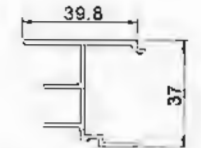

Edge Seal Close-up YLJ388A12
T=1.4mm 0.51kg/m

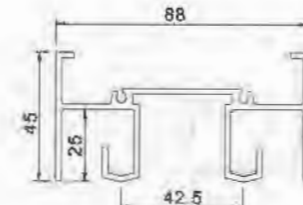

Upper Rail YLJ388A01B
T=2.0mm 1.633kg/m

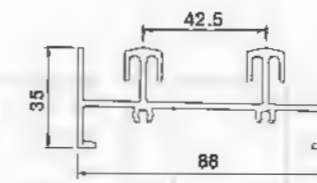

Bottom Rail YLJ388A02D
T=2.0mm 1.398kg/m

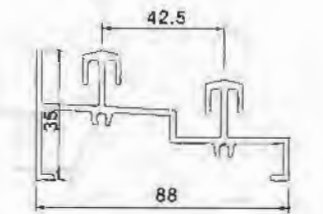

Bottom Rail YLJ388A02B
T=2.0mm 1.511kg/m

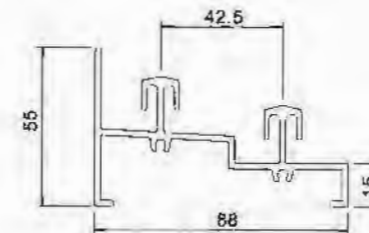

Bottom Rail YLJ388A02F
T=2.0mm 1.565kg/m

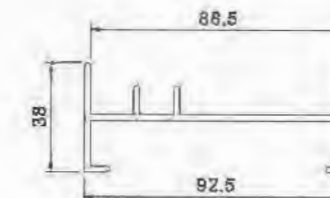

Edge Seal YLJ388A03
T=2.0mm 1.074kg/m

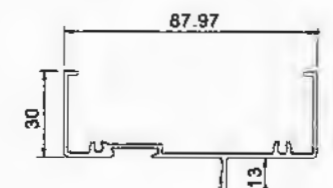

Above Fixed YLJ18810T
T=1.45mm 0.767kg/m

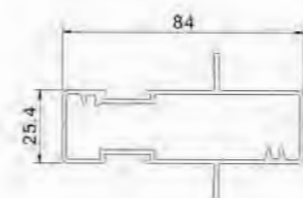

Upper Rail YLJ188A13T
T=1.45mm 1.101kg/m

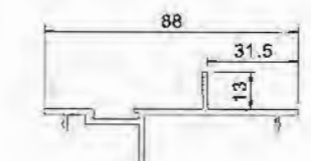

Upper Rail Cover YLJ388A13
T=2.0mm 10.708kg/m

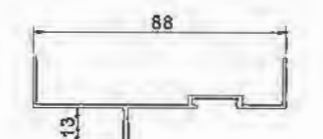

Edge Seal Cover YLJ388A17
T=2.0mm 0.489kg/m

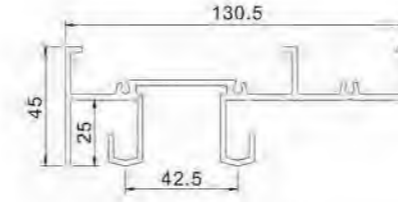
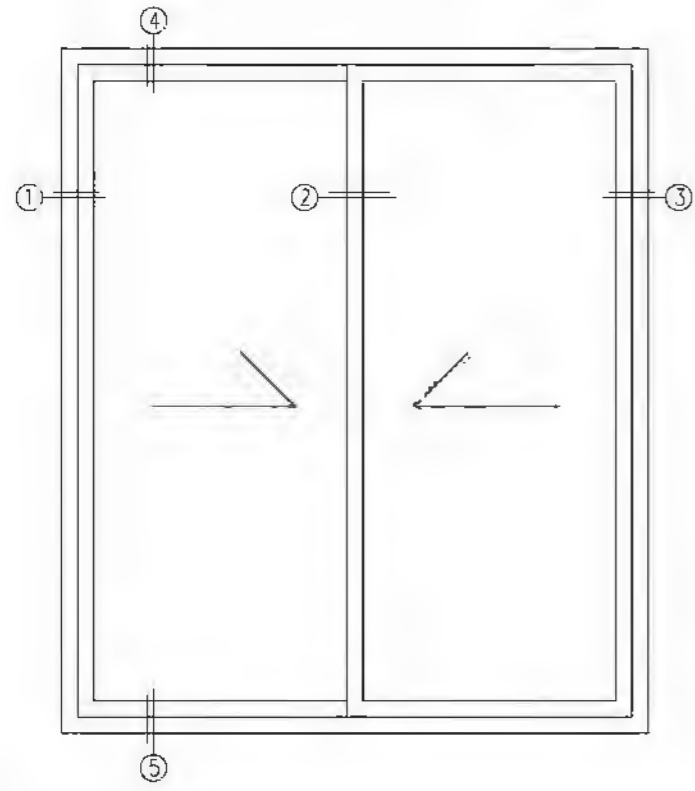

Upper Rail YLJ388A01C
T=2.0mm 1.896kg/m

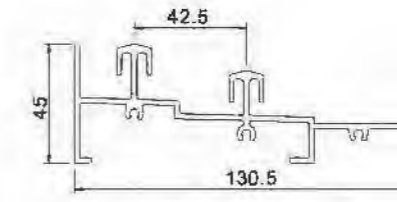

Bottom Rail YLJ388A02C
T=2.0mm 1.918kg/m

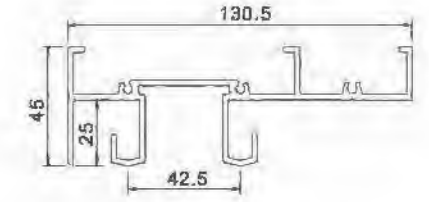

Upper Rail YLJ388A01C
T=2.0mm 1.896kg/m

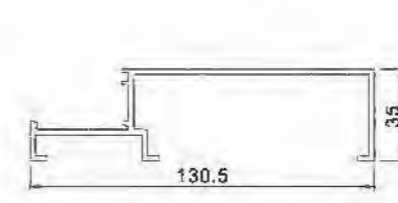

Edge Seal YLJ388A03C
T=2.0mm 1.285kg/m

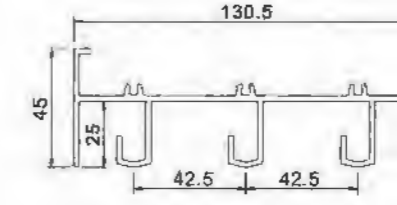

Upper Rail YLJ388A01G
T=2.0mm 2.097kg/m

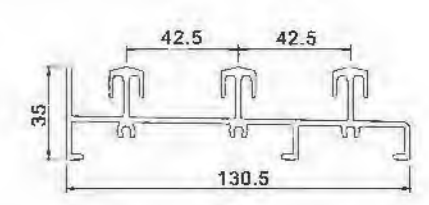

Bottom Rail YLJ388A02G
T=2.0mm 2.026kg/m

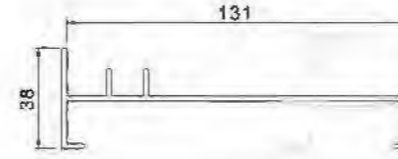

Edge Seal YLJ388A03G
T=2.0mm 1.306kg/m

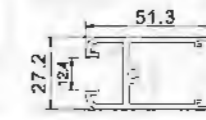

Above YLJ388A04H
T=2.0mm 0.80kg/m

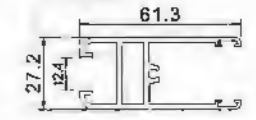

Below YLJ388A05H
T=2.0mm 1.027kg/m

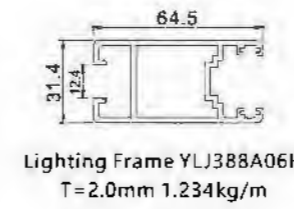
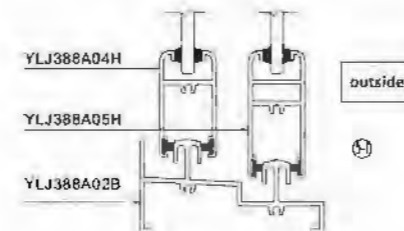
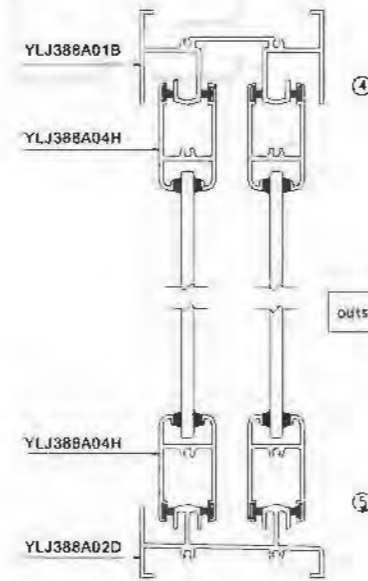
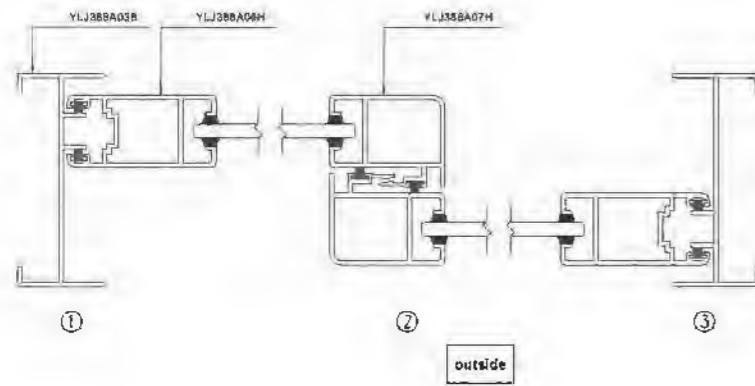

Lighting Frame YLJ388A06H
T=2.0mm 1.234kg/m

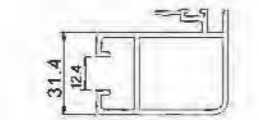

Hook Frame YLJ388A07AH
T=2.0mm 1.126kg/m

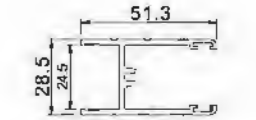

Above YLJ388A04HZK
T=2.0mm 0.733kg/m

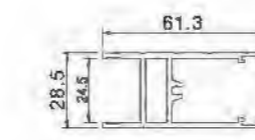

Below YLJ388A05HZK
T=2.0mm 1.004kg/m

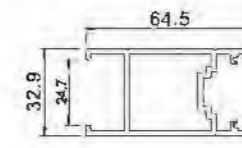

Lighting Frame YLJ388A06HZK
T=2.0mm 1.164kg/m

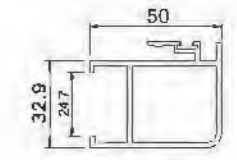

Hook Frame YLJ388A07HZK
T=2.0mm 1.036kg/m

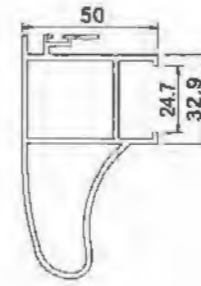
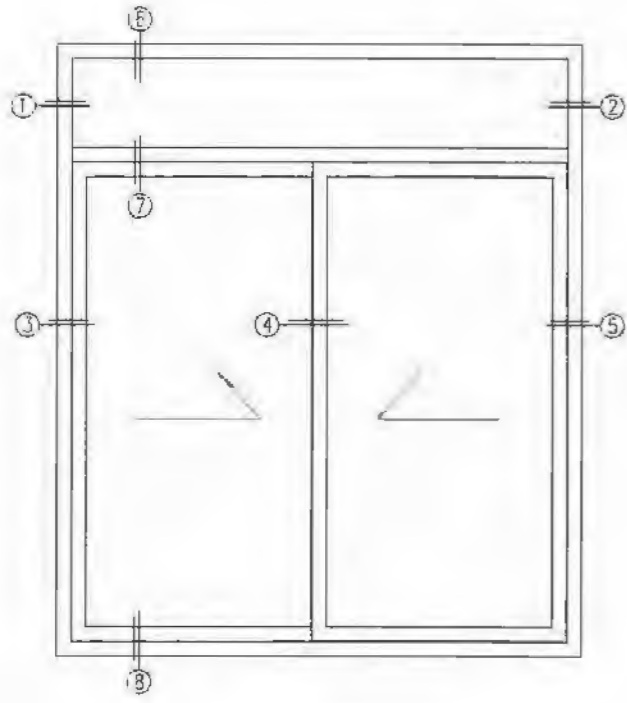

Hook Frame YLJ388A07BZK
T=2.0mm 1.67kg/m

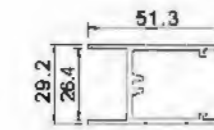

Above YLJ388A04KZK
T=2.0mm 0.708kg/m

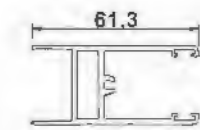

Below YLJ388A05KZK
T=2.0mm 0.955kg/m

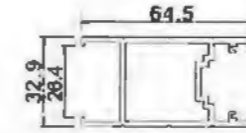

Lighting Frame YLJ388A06KZK
T=2.0mm 1.128kg/m

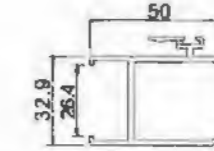

Hook Frame YLJ388A07KZK
T=2.0mm 0.995kg/m

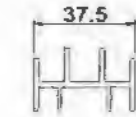

Close-up Material YLJ388A08
T=1.9mm 0.572kg/m

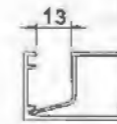

Fixed Glass Bead YLJ388A11A
T=1.1mm 0.246kg/m

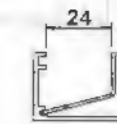

Fixed Glass Bead YLJ388A11
T=1.1mm 0.238kg/m

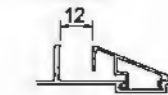

Fixed Glass Bead YLJ38820
T=0.9mm 0.16kg/m

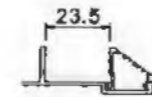

Fixed Glass Bead YLJ23800G
T=0.9mm 0.112kg/m

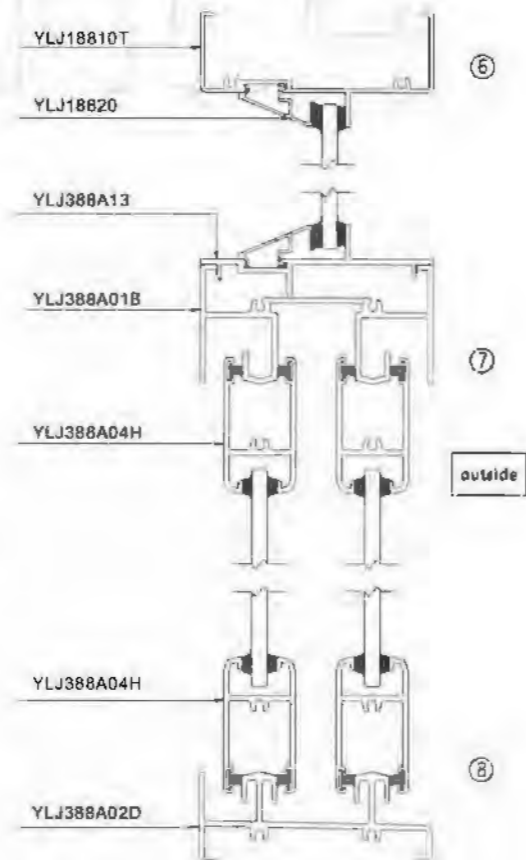
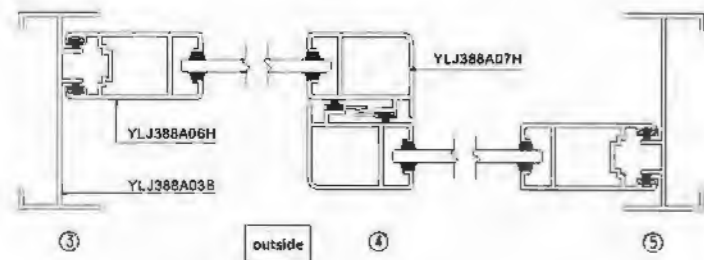
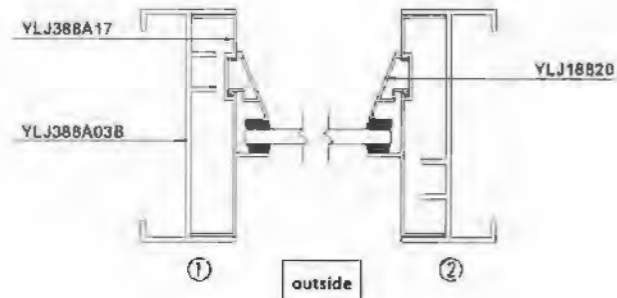

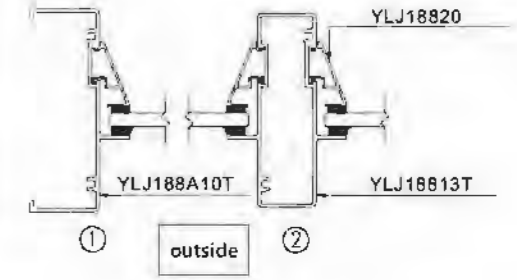
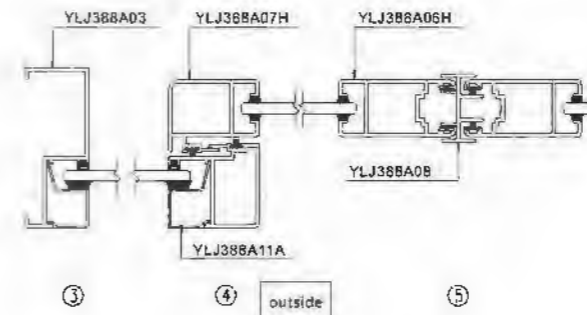
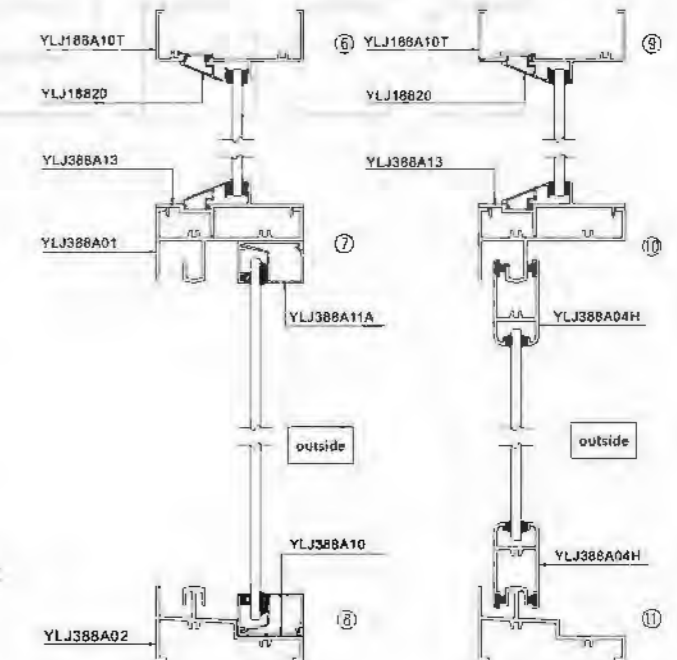
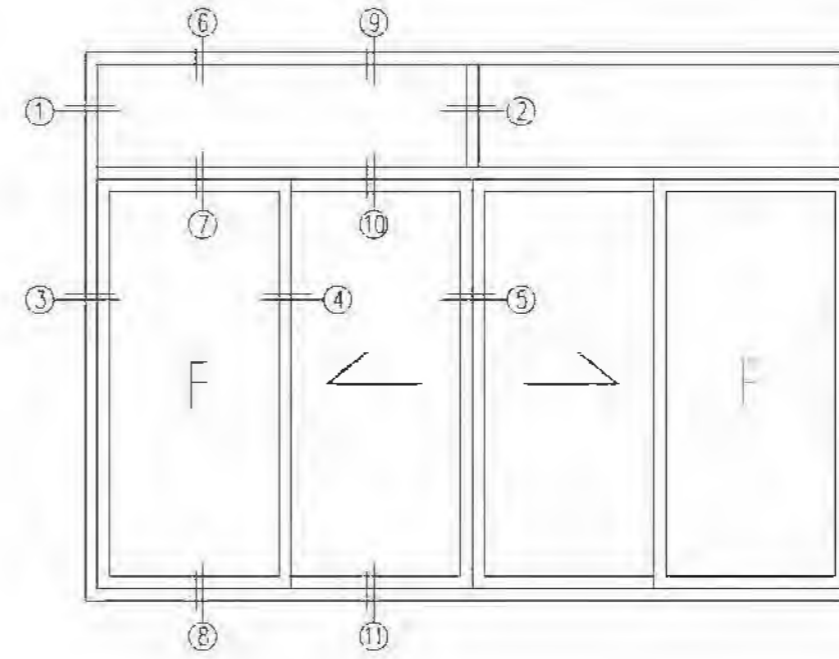
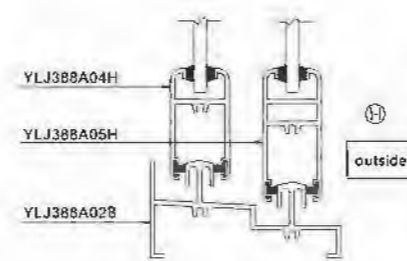
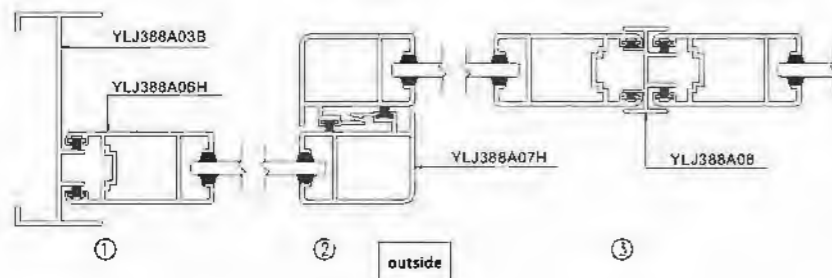
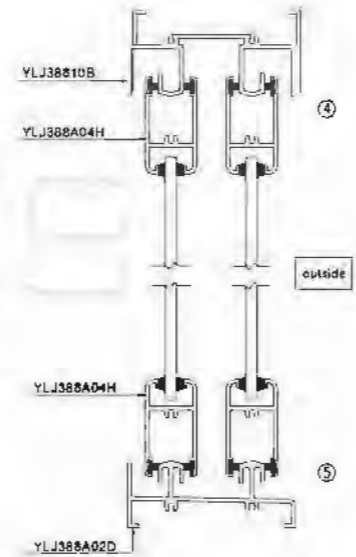
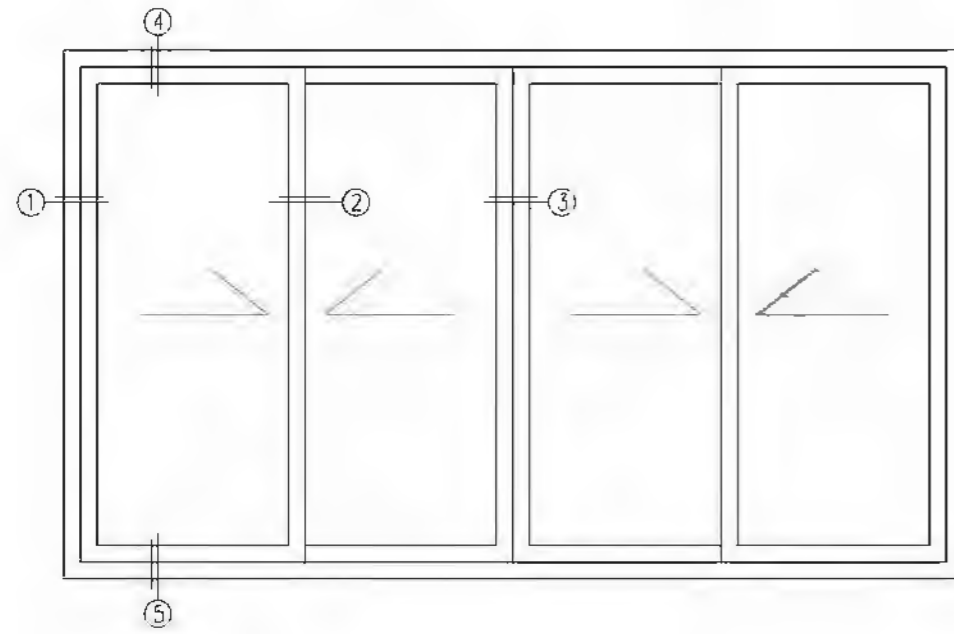

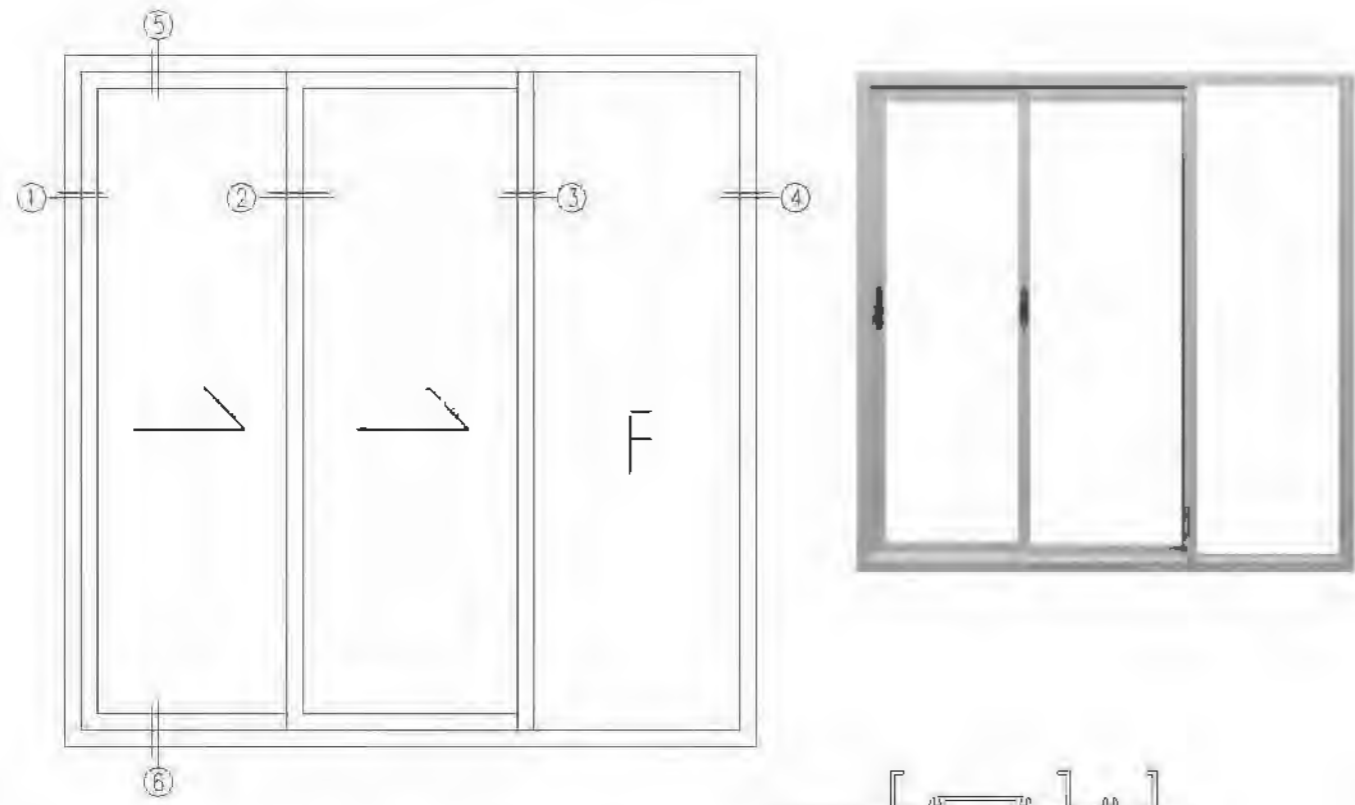

37

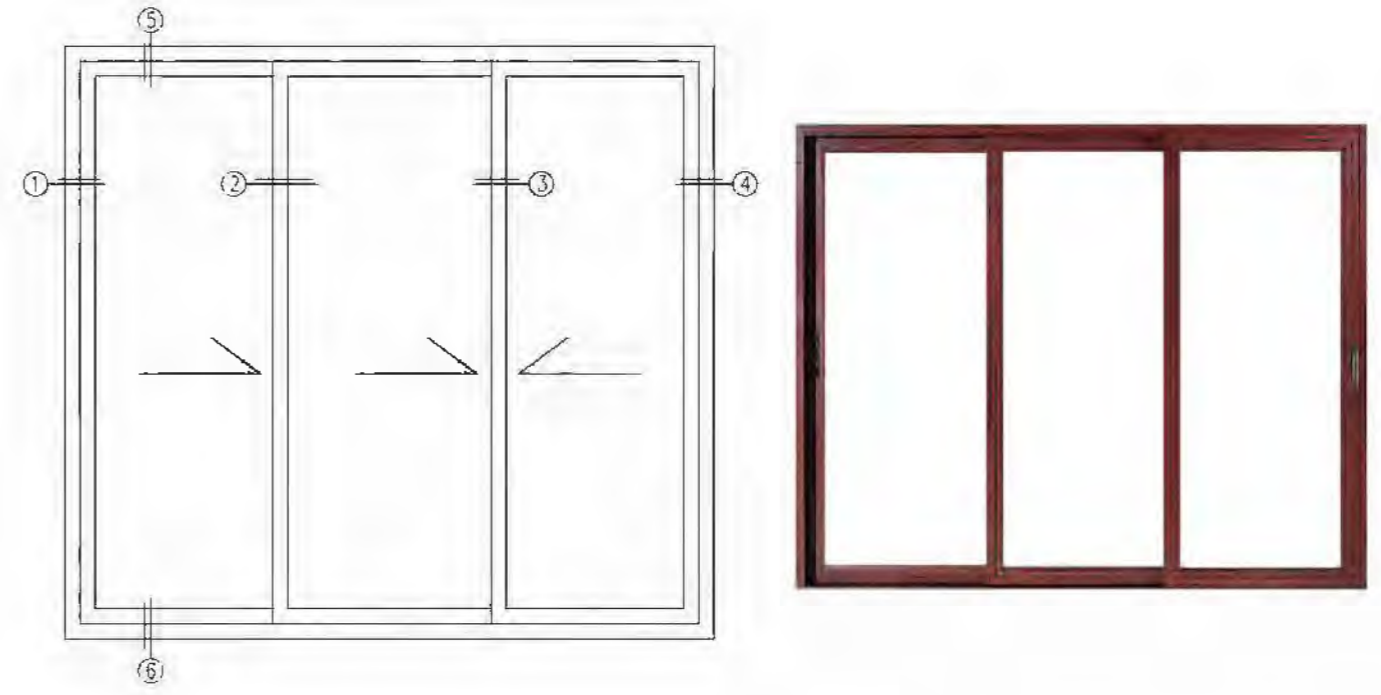
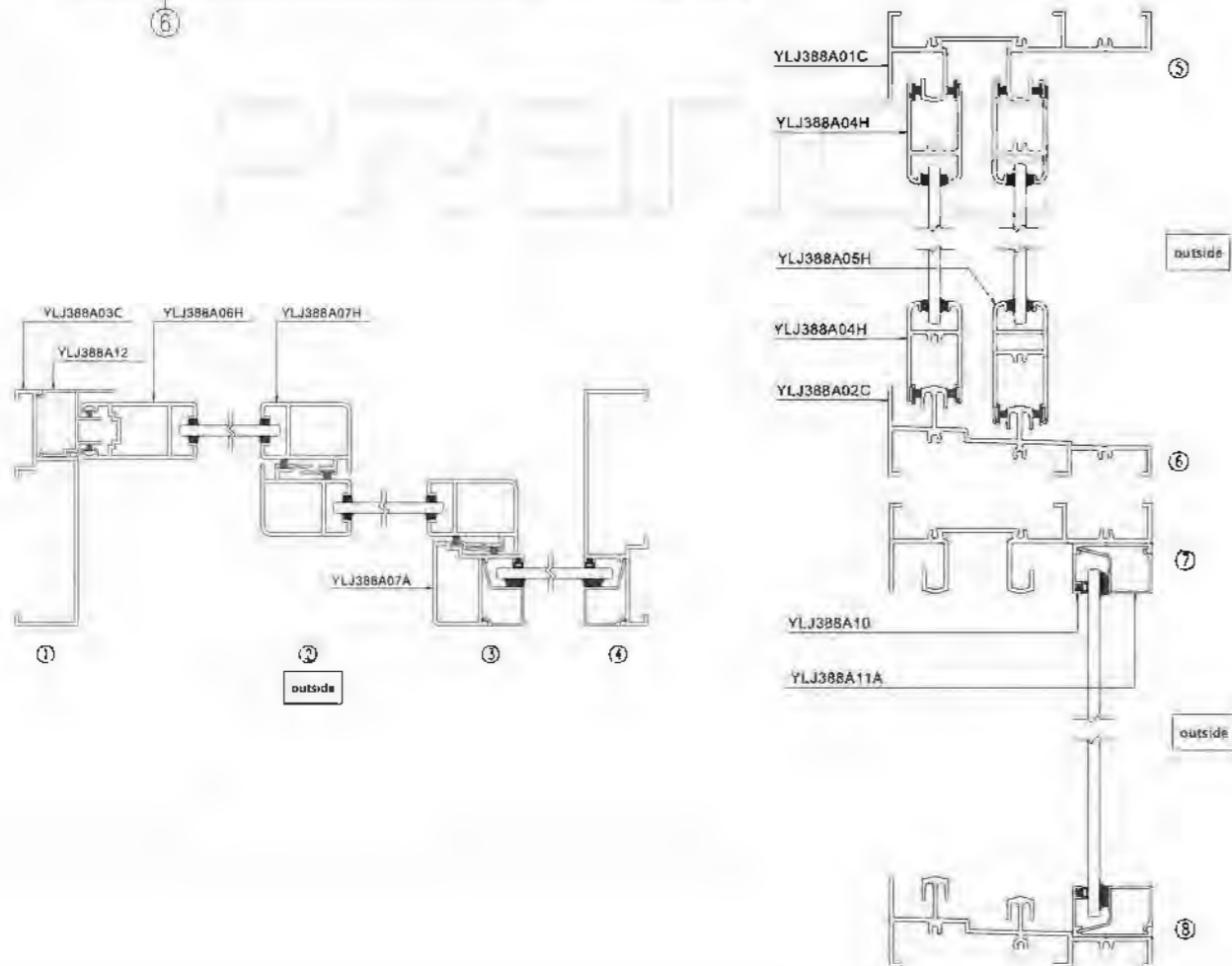

38

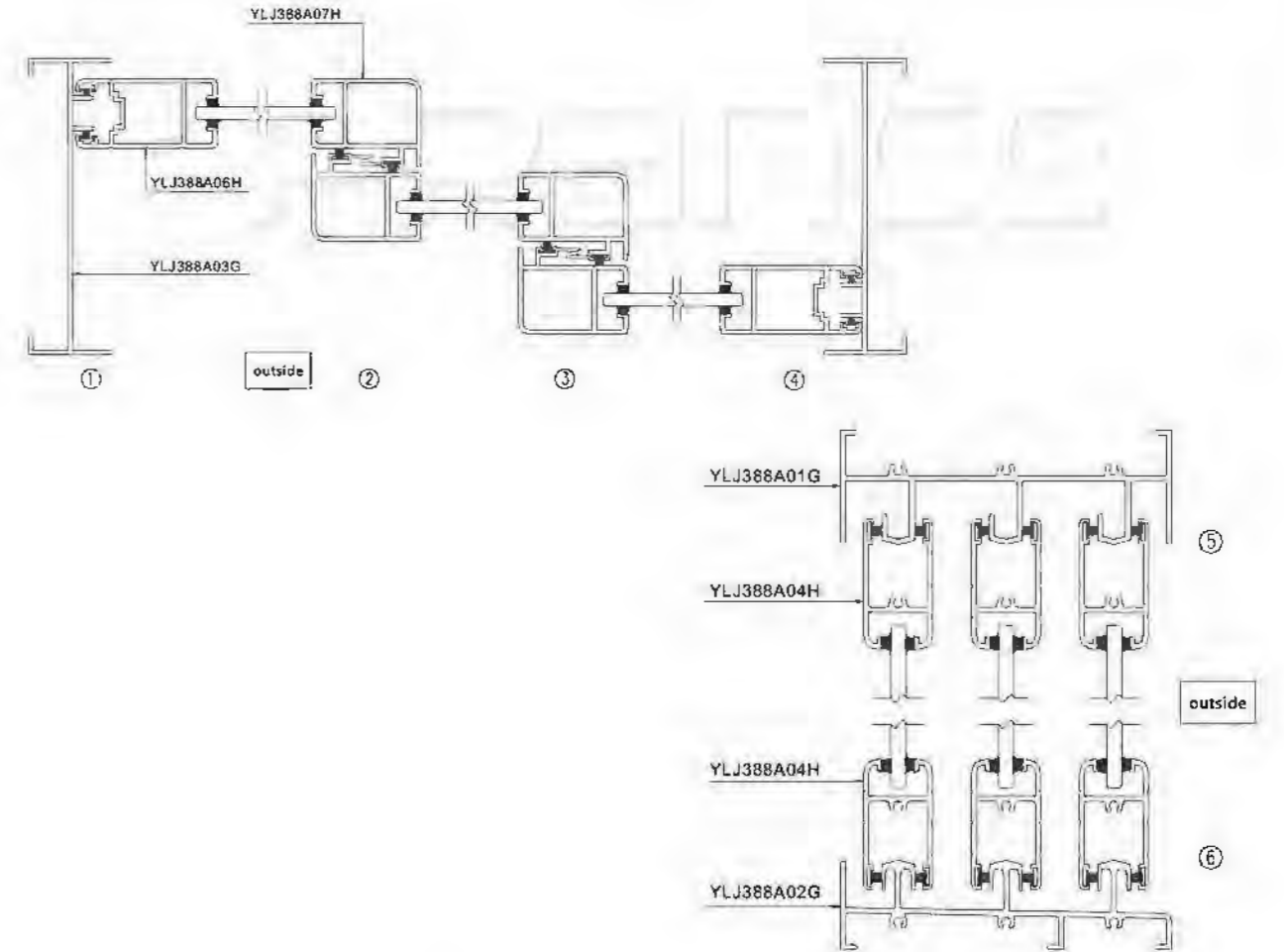



The sliding door will change along with the subjective will , according to requirements, structure , decorative style and the space



SHOWING



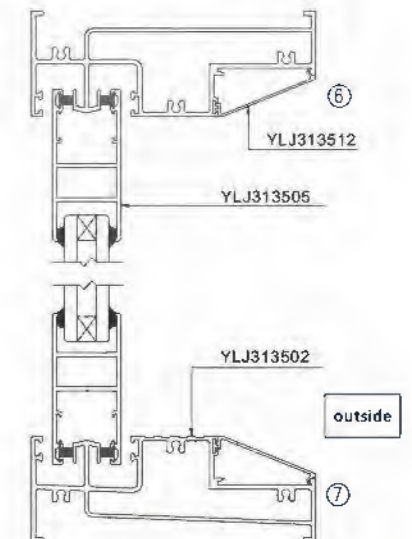
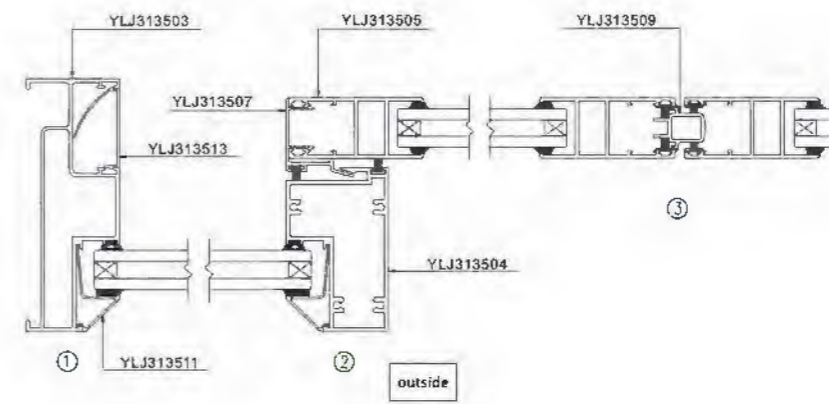
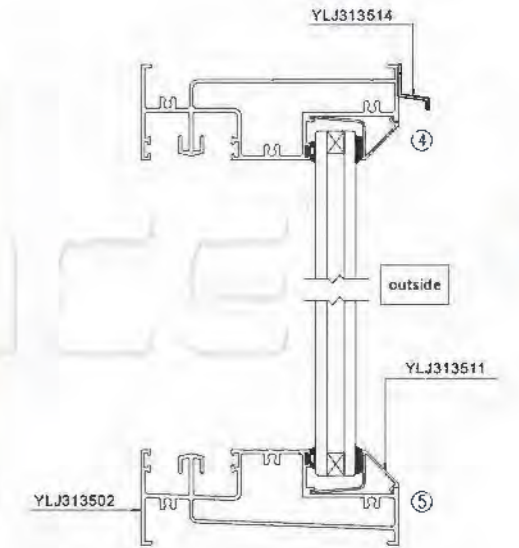
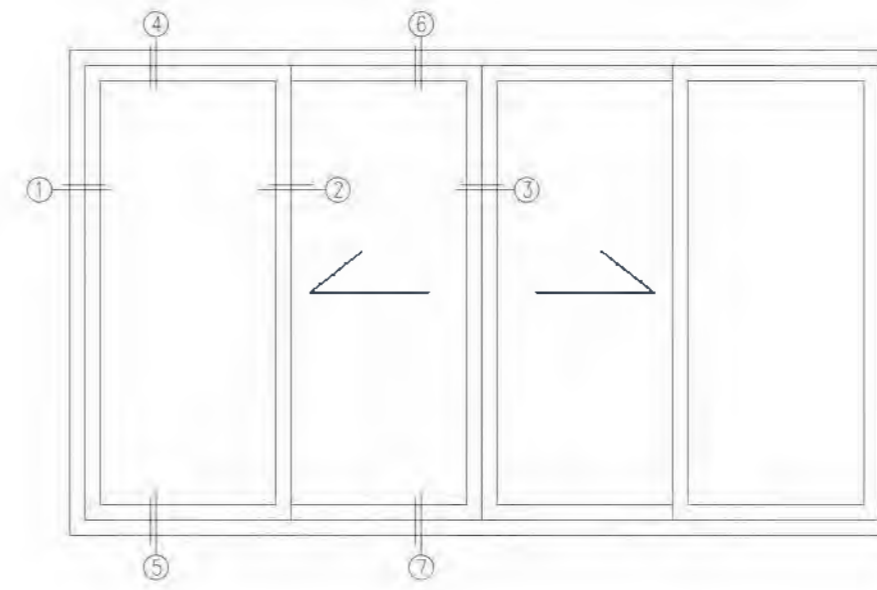

PRODUCT INSTRUCTION

Model: 135 balcony door
Surface Treatment: PVDF Coating; Powder Coating; Anodized; Electrophoretic Coating
Profile Thickness: Window: 1.4mm; Door: 2.0mm
Material of Profile: 6063/T5, 6063/T6
Glass Selection: Tempered Glass/Resective Coated Glass(5, 6, 8, 10), Tempered Insulated Glass Units(5+9A+5, 6+9A+6)
Hardware Selection: Chinese and German hardware are available(Kin Long, HeHe, Roto)
Applicable Range: Office Buildings, Residential, Villas, Apartments, Schools, Hospitals and other properties of the building envelope system

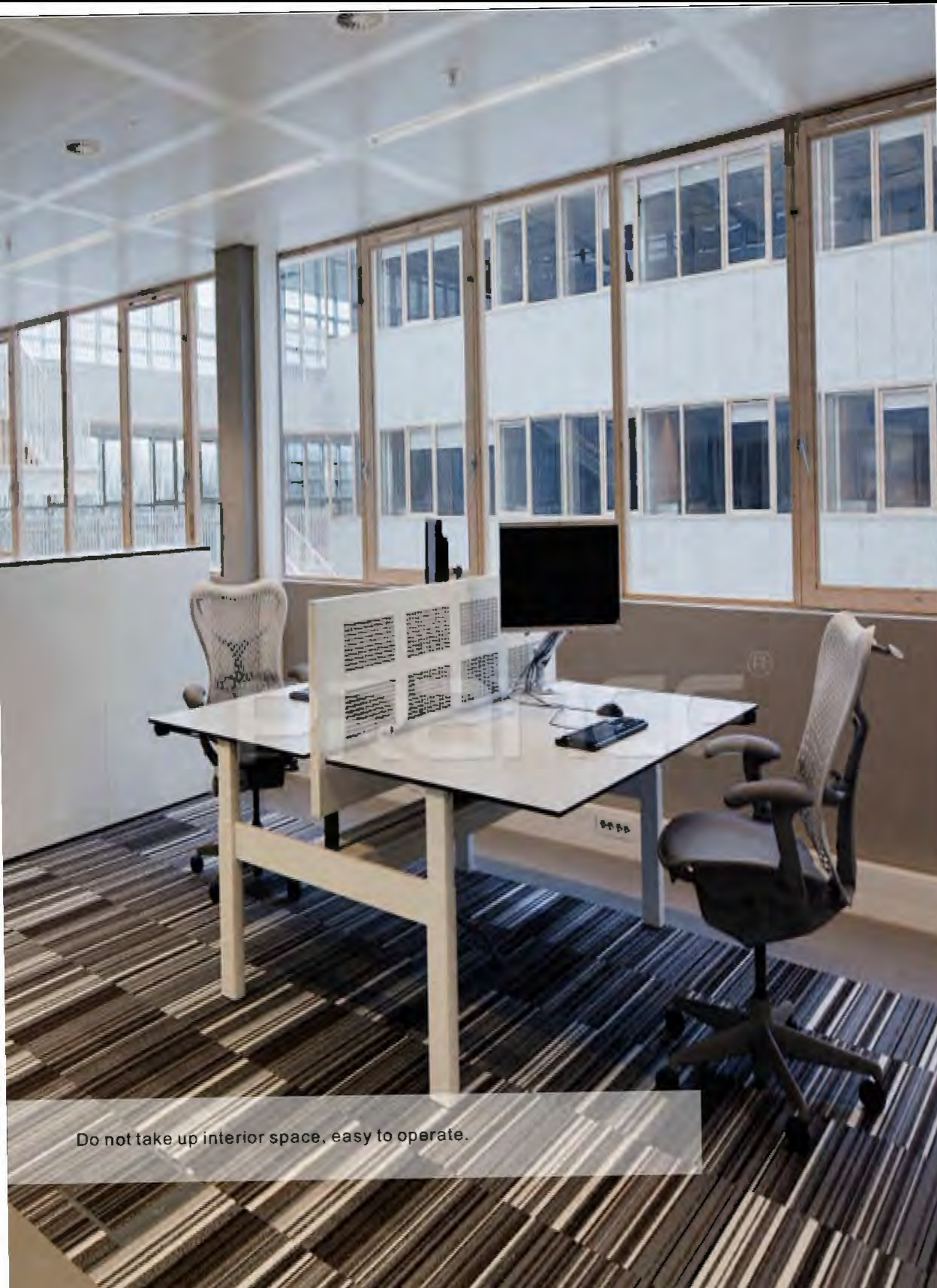

Do not take up interior space, easy to operate.



SHOWING



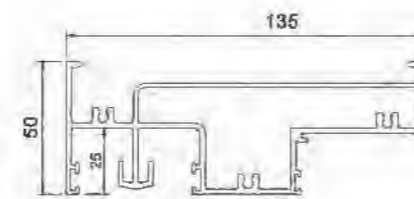
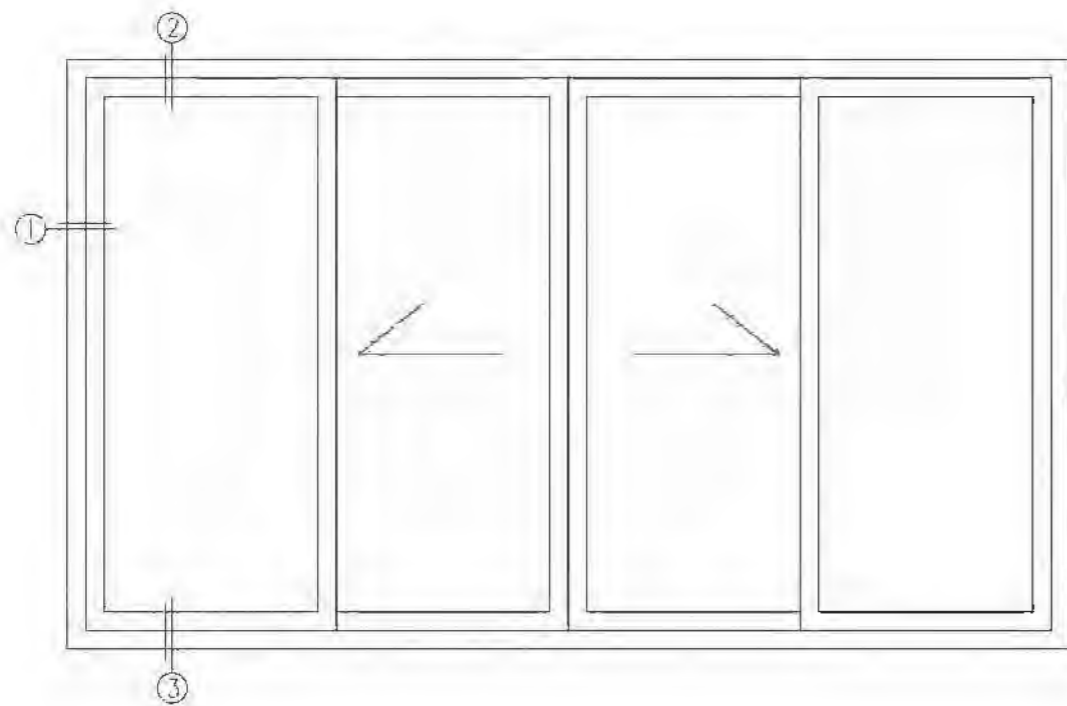

Upper Rail YLJ313501
T=2.0mm 2.558kg/m

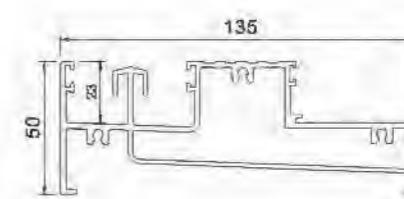

Bottom Rail YLJ313502
T=2.0mm 2.519kg/m

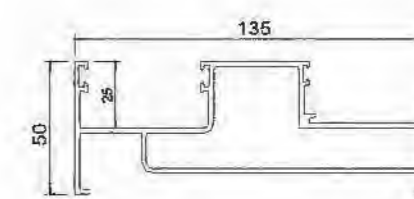

Edge YLJ313503
T=2.0mm 2.083kg/m

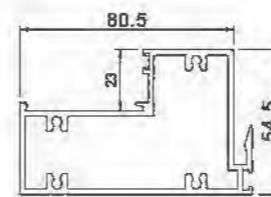

Fixed Column YLJ313504
T=2.0mm 1.948kg/m

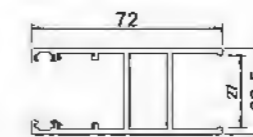

Doors And Windows YLJ313505
T=2.0mm 1.188kg/m

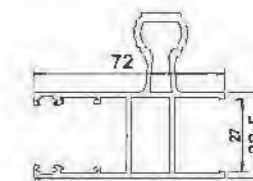

Handles Of Doors And Windows
YLJ313506
T=2.0mm 1.664kg/m

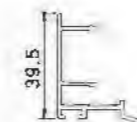

Hook YLJ313507
T=1.4mm 0.424kg/m

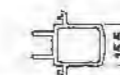

Close-up YLJ313509
T=1.4mm 0.378kg/m

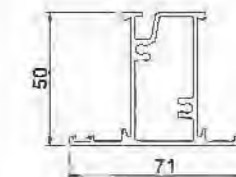

Fixed Middle YLJ313515
T=1.6mm 1.116kg/m

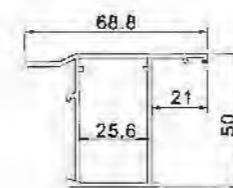
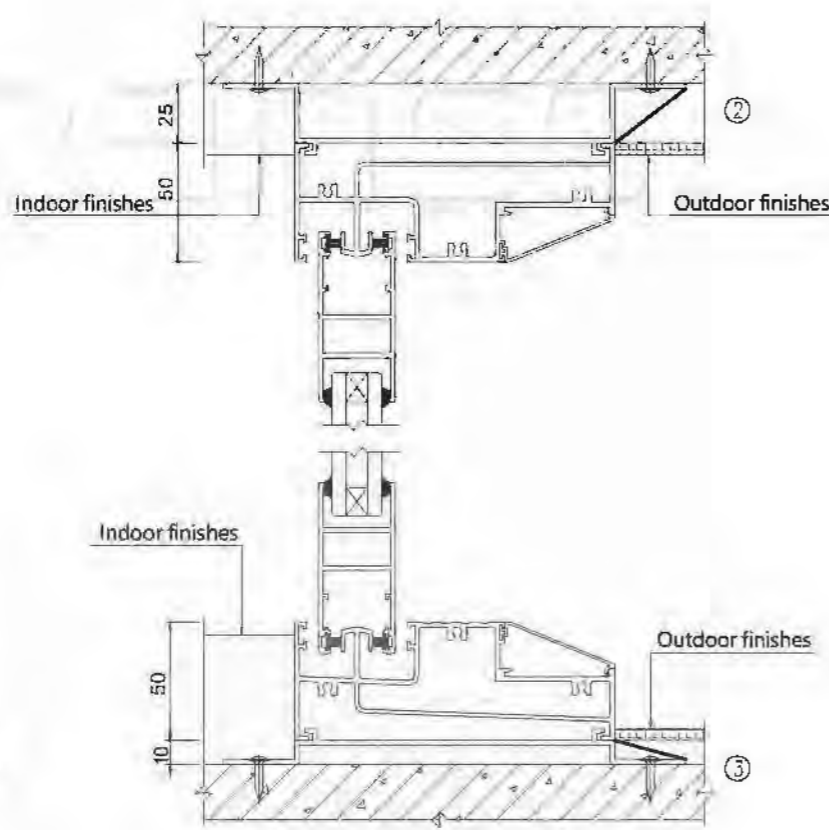
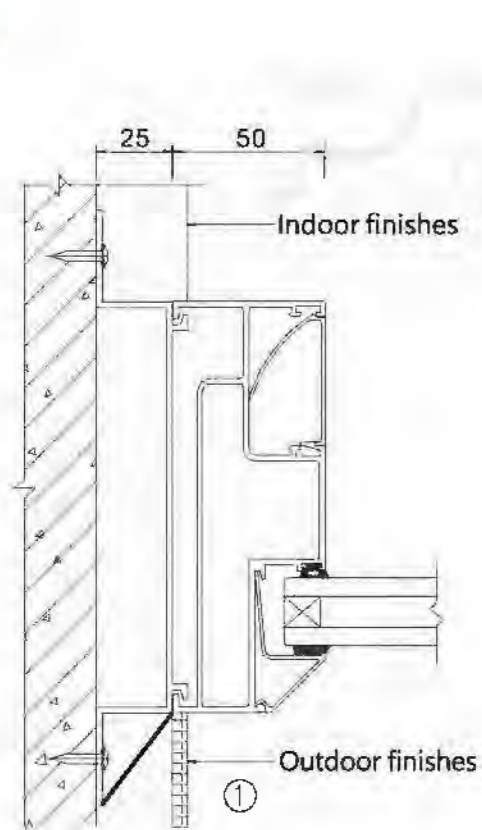

Sash YLJ313516
T=1.6mm 0.927kg/m

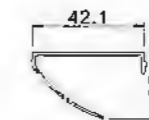

Door Frame Close-up Material
YLJ313513
T=1.2mm 0.262kg/m



Door Frame Close-up Material
YLJ313512
T=1.1mm 0.177kg/m

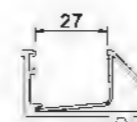

Frame Glass Bead YLJ35011
T=1.0mm 0.23kg/m

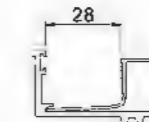

Frame Glass Bead YLJ25015J
T=1.0mm 0.243kg/m

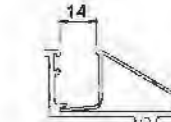

Frame Glass Bead YLJ313511A
T=1.0mm 0.225kg/m

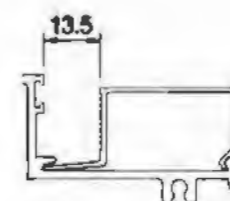
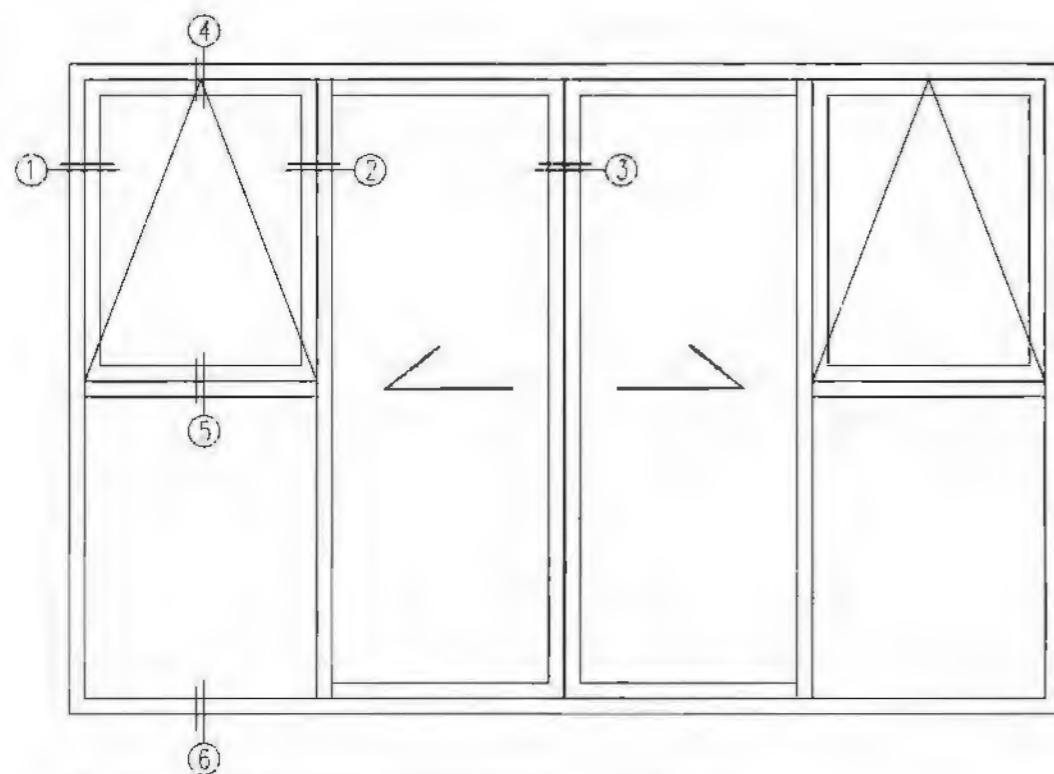

Frame Glass Bead YLJ25015K
T=1.0mm 0.253kg/m

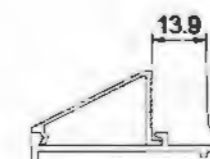

Sash Glass Bead YLJ25016
T=1.0mm 0.185kg/m

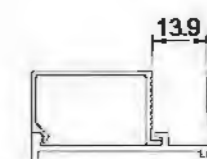

Sash Glass Bead YLJ25016M
T=1.0mm 0.211kg/m

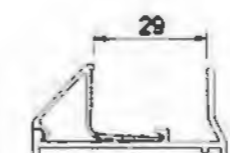

Sash Glass Bead YLJ25016R
T=1.0mm 0.187kg/m

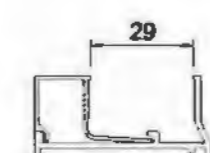

Sash Glass Bead YLJ25016B
T=1.0mm 0.204kg/m

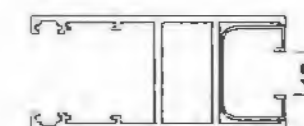

Door Leaf Glass Groove
YLJ313517
T=0.9mm 0.185kg/m



Waterproof Cover YLJ313514
T=1.2mm 0.097kg/m

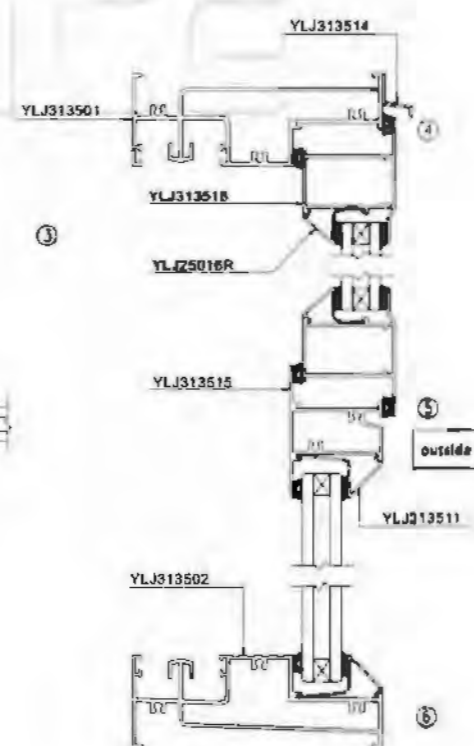



Firm and secured, contains good performance against shaking, wind, and anti-theft.



SHOWING

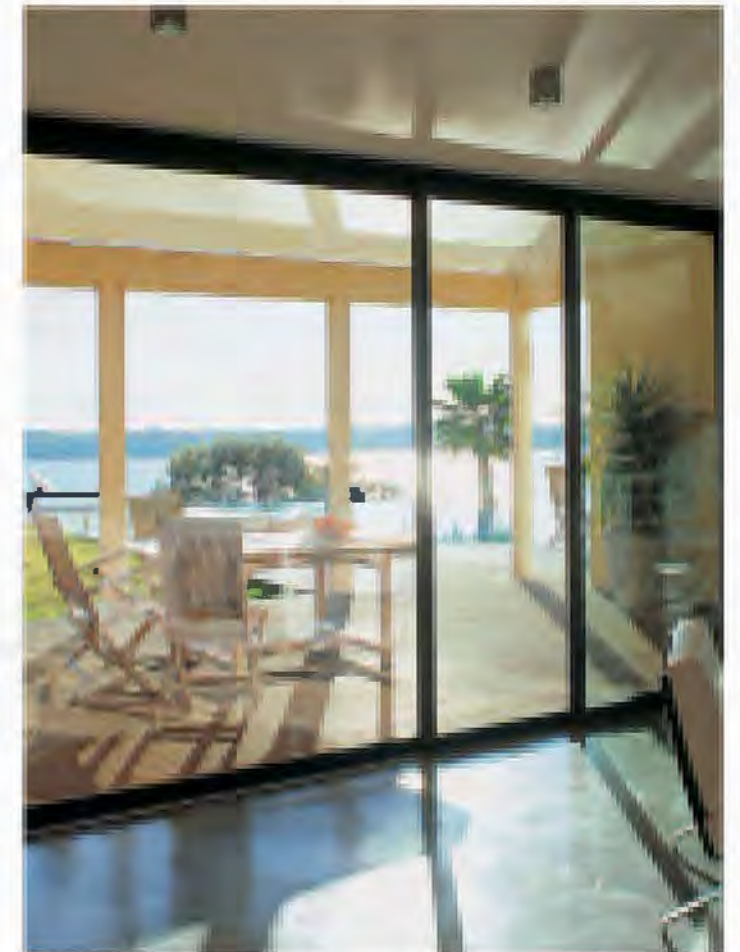

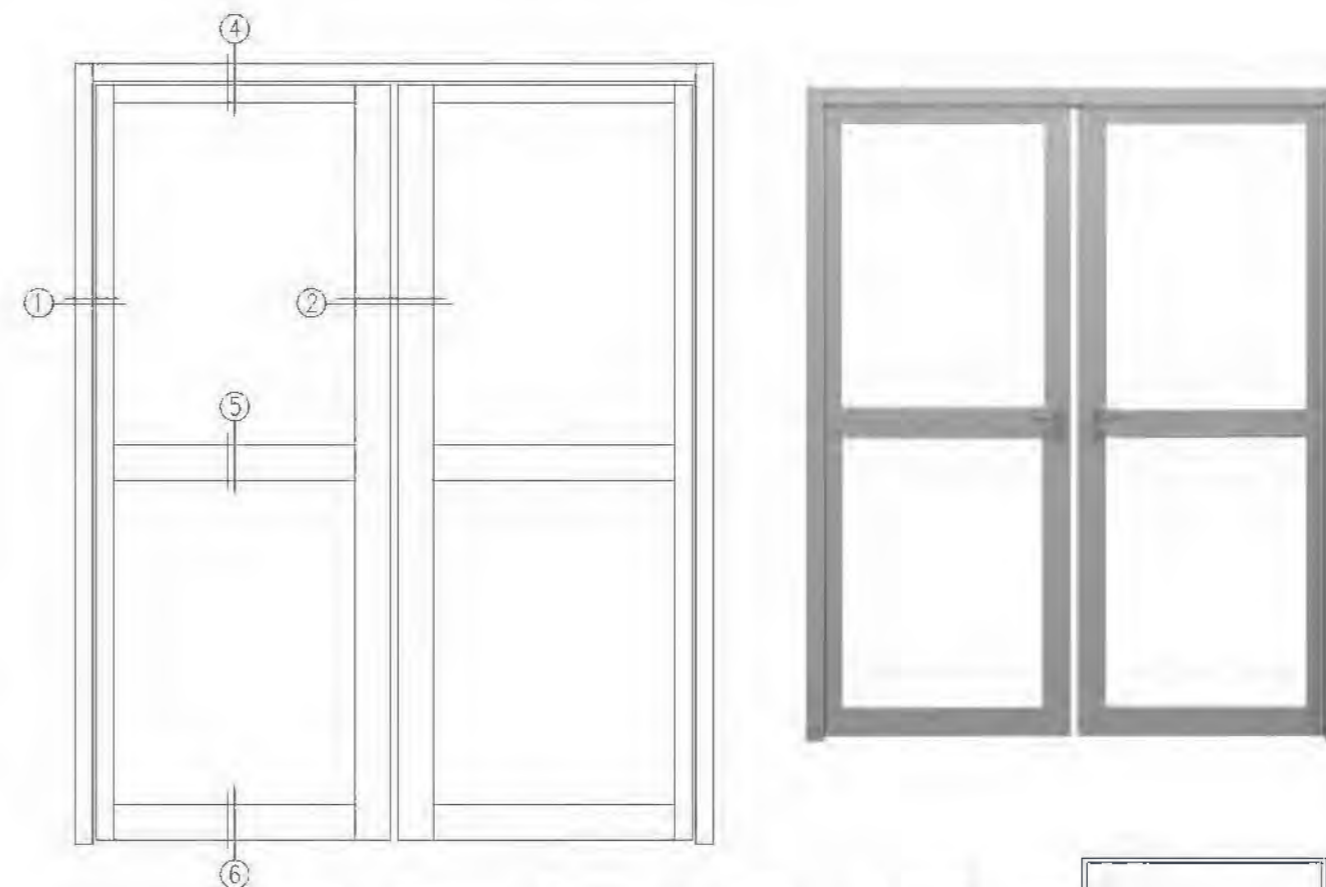

49

50

PRODUCT INSTRUCTION

Model: 46 floor spring door

Aluminum profile surface work: PVDF Coating (double/triple coating), Powder Coating, Anodization, coloring electrophoresis. Two choices can be used combine.

Aluminum profile surface color choices: PVDF Coating (Powder Coating): choice of color is plenty, depends on the need of customer.

Anodization: Choice of color is not many, mainly silver, titanium, bronze, black, champagne .

Coloring electrophoresis coating: silver, champagne, golden, black, color imitation stainless steel.

Width of aluminum profile: Window profile(standard) 1.4mm; Door profile(standard) 2.0mm. Non-standard width can be molded depends on the situation of a project or a specific product.

Aluminum profile material: 6063/T5, 6063/T6

Choice of color: Monolithic temper glass/Temper film coating glass (5、6、8、10、12、15 etc.)

Choice of Hardware: Top Chinese Brand (KIN LONG, HEHE) ; Top World-wide Brand (Roto-frank, SiegeniaA)

Other materials: (Sealants, tapes) use Chinese top brands

Application Scale: Mall ground floor, office buildings, houses, villas, apartments, schools, hospitals, large factories, and other properties of the envelope system

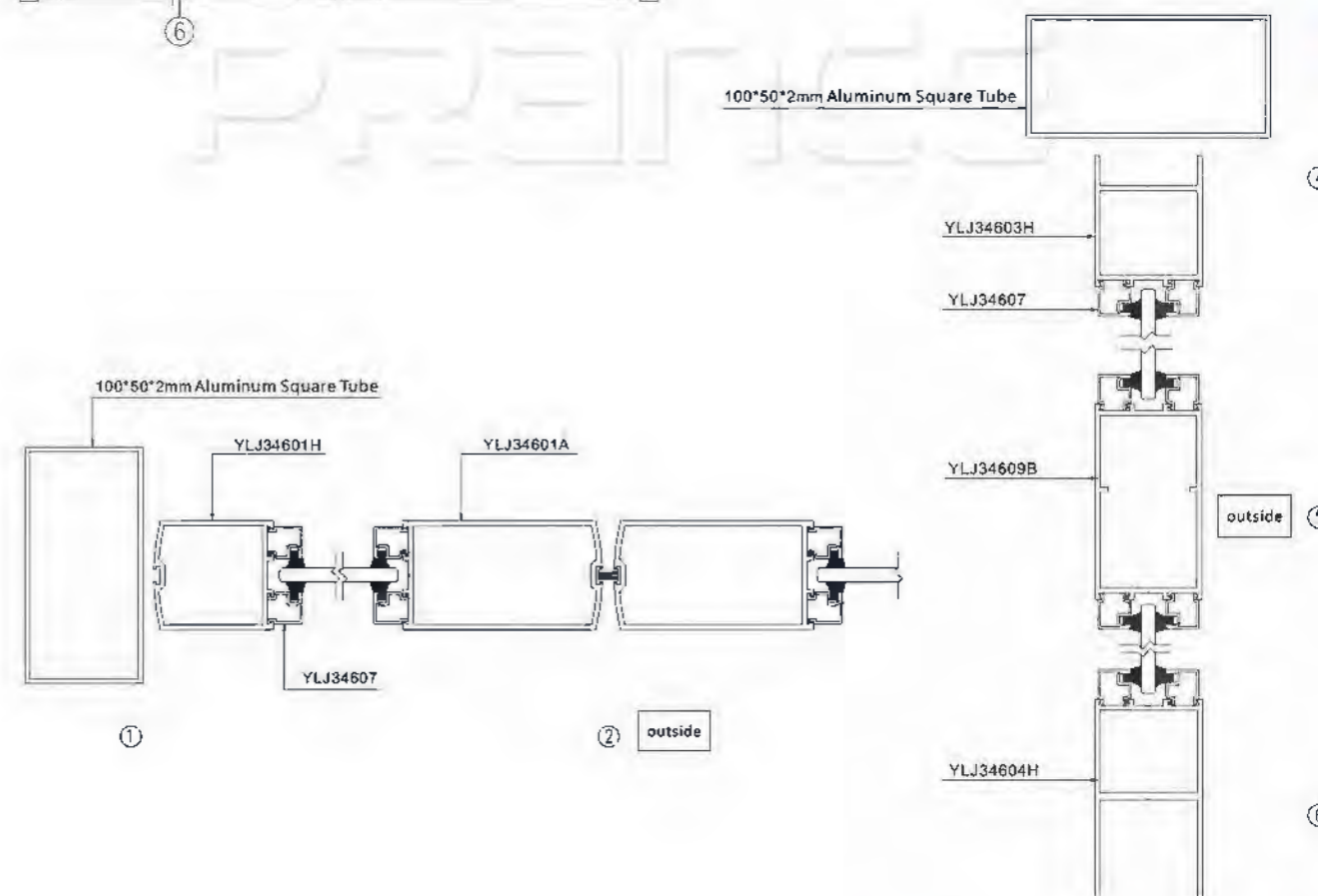

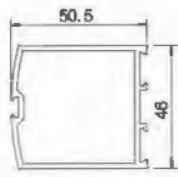

Door Leaf Vertical Frame
YLJ34601H
T=2.0mm 1.066kg/m

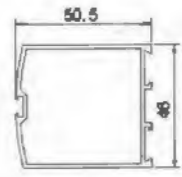

Door Leaf Vertical Frame
YLJ34601
T=1.5mm 0.832kg/m

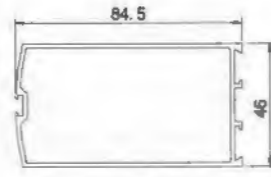

Door Leaf Vertical Frame
YLJ34610
T=1.6mm 1.167kg/m

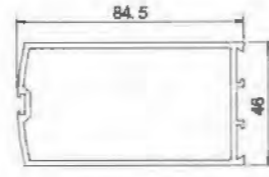

Door Leaf Vertical Frame
YLJ34610A
T=2.1mm 1.503kg/m

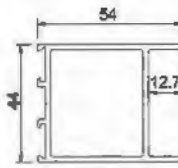

Upper Door Leaf YLJ34603H
T=2.0mm 1.061kg/m

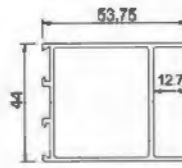

Upper Door Leaf YLJ34603
T=1.5mm 0.844kg/m

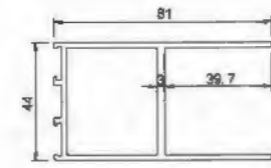

Lower Door Leaf YLJ34604A
T=2.0mm 1.448kg/m

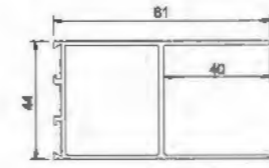

Lower Door Leaf YLJ34604
T=1.5mm 1.064kg/m

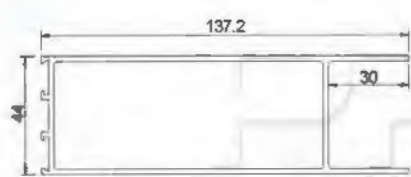

Upper Door Leaf YLJ34611H
T=2.0mm 1.97kg/m

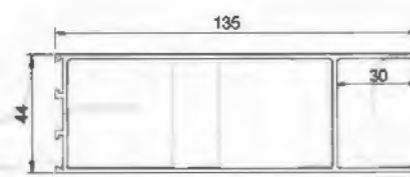

Upper Door Leaf YLJ34611
T=1.6mm 1.577kg/m

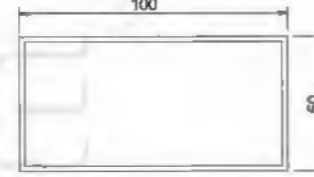

100*50*2mm Aluminum Square Tube
T=1.2mm 1.594kg/m

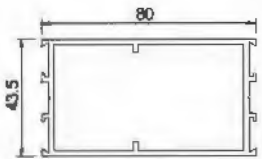

Middle Door Leaf YLJ34609B
T=2.0mm 1.404kg/m

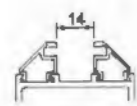

Glass Bead YLJ34606
T=0.9mm 0.122kg/m

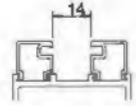

Glass Bead YLJ34607
T=0.9mm 0.14kg/m

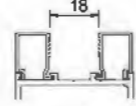

Glass Bead YLJ34606B
T=0.9mm 0.136kg/m

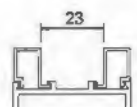

Glass Bead YLJ34625
T=1.0mm 0.123kg/m

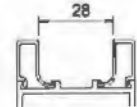

Glass Bead YLJ34625A
T=1.0mm 0.129kg/m

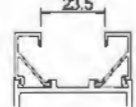

Glass Bead YLJ34623
T=1.1mm 0.151kg/m

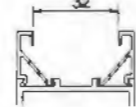

Glass Bead YLJ34623A
T=1.1mm 0.138kg/m



Elegant appearance, Long durance, large opening angle, free to open from inside or outside.



Use of entrance closer. Open force is moderate, closing force is gentle. Our spring doors avoid the disadvantages of floor springs being short life usage and often replacing.



SHOWING





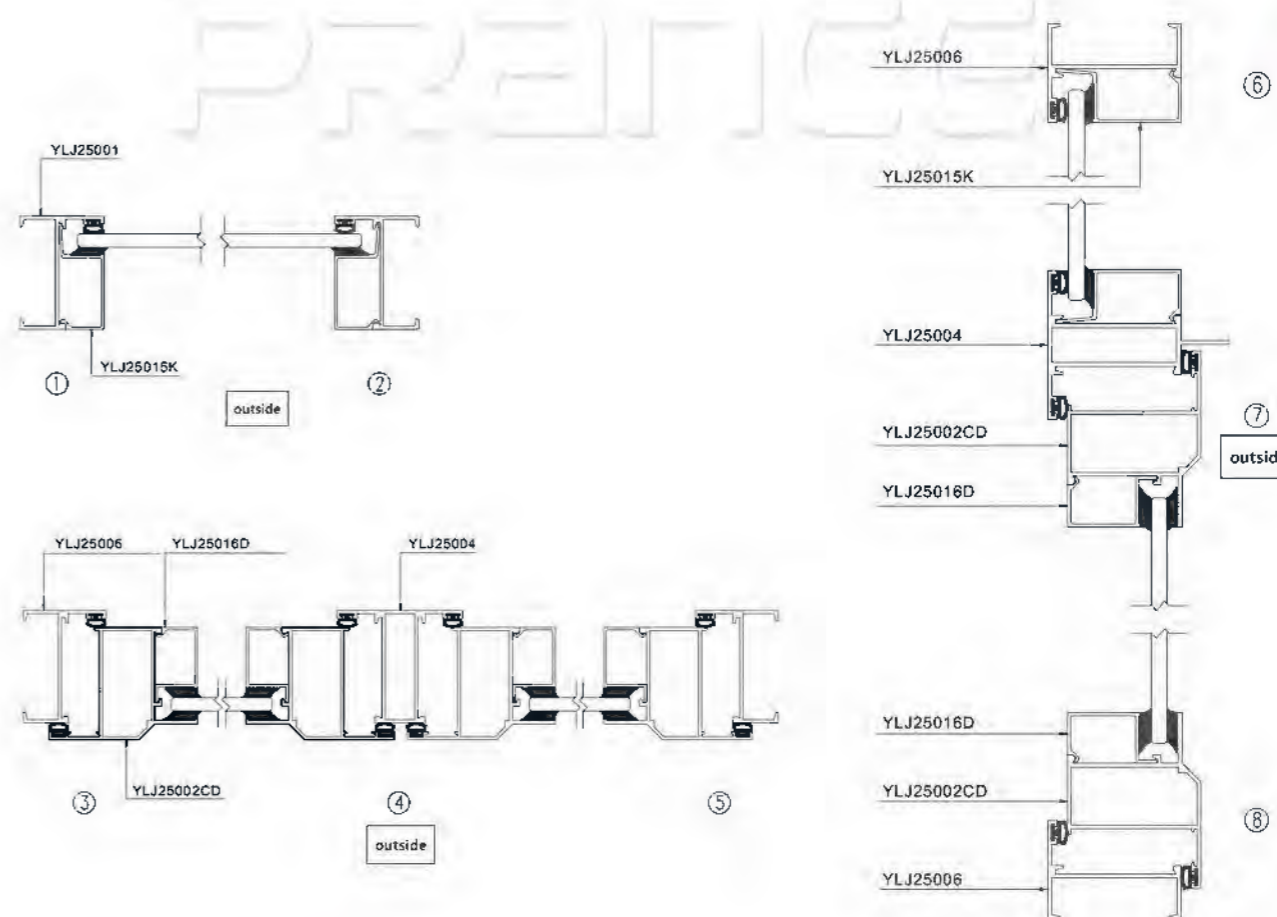
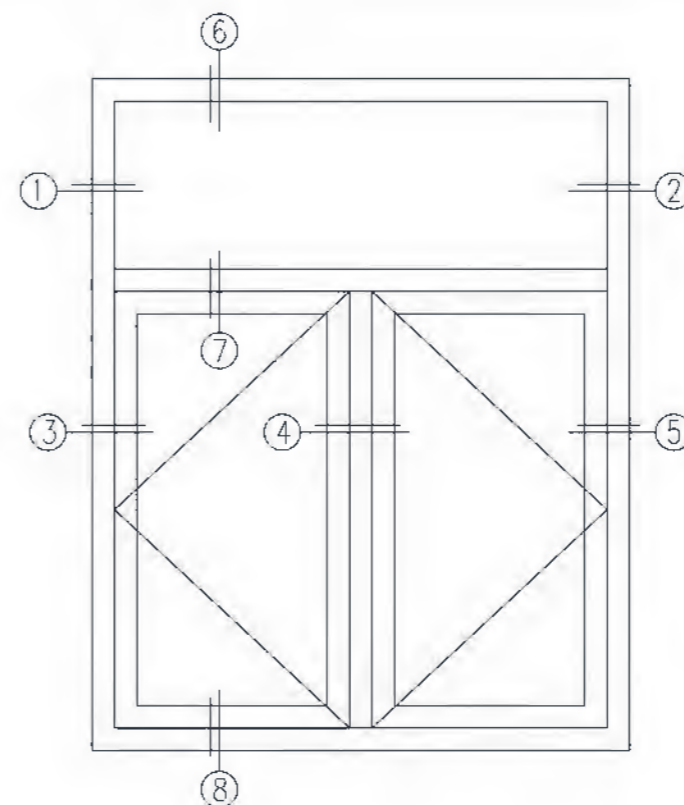

PRODUCT INSTRUCTION

Model: 50 Casement window

Surface Treatment: PVDF Coating; Powder Coating; Anodized; Electrophoretic Coating

Profile Thickness: Window: 1.4mm; Door: 2.0mm

Material of Profile: 6063/T5、6063/T6

Glass Selection: Tempered Glass/Resective Coated Glass(5、6、8、10), Tempered Insulated Glass Units(5+9A+5、6+9A+6)

Hardware Selection: Chinese and German hardware are available(Kin Long, HeHe, Roto)

Applicable Range: Office Buildings, Residential, Villas, Apartments, Schools, Hospitals and other properties of the building envelope system

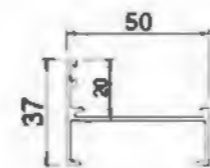
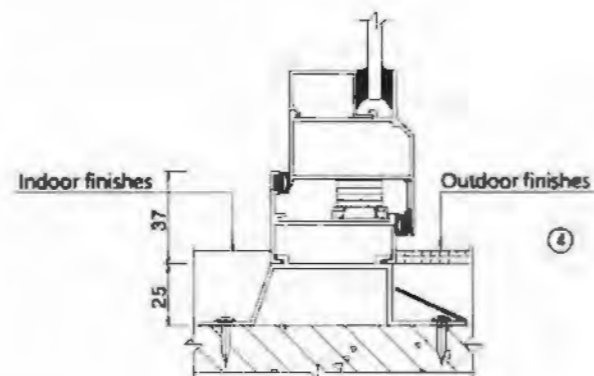
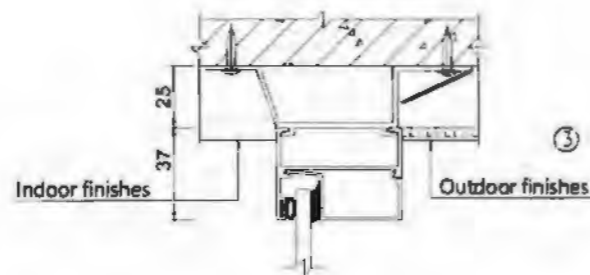
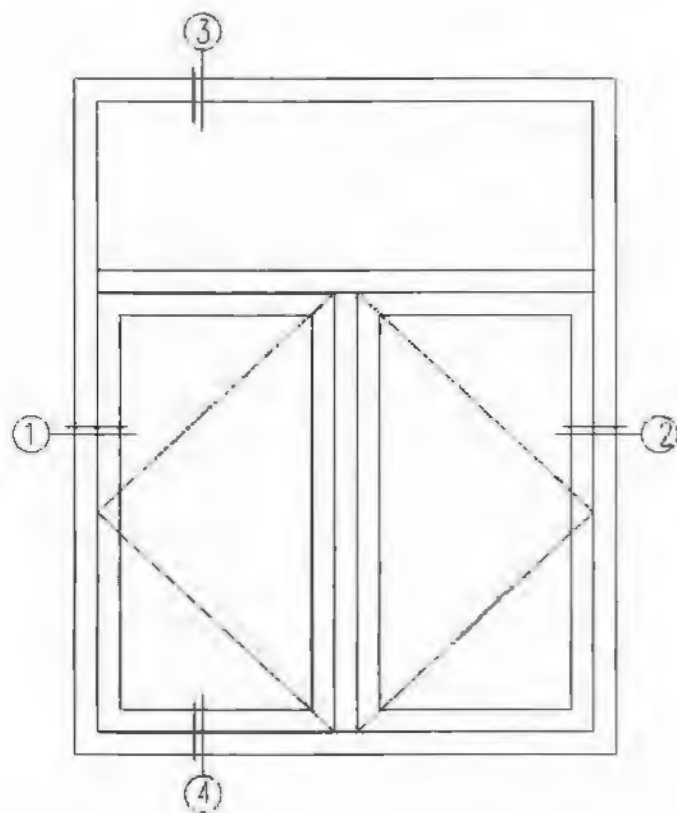

Frame YLJ25001
T=1.4mm 0.478kg/m

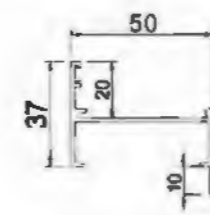

Frame YLJ25006
T=1.4mm 0.51kg/m

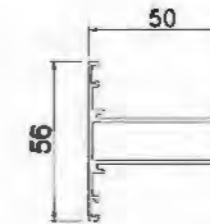

Mullion YLJ25004
T=1.4mm 0.766kg/m

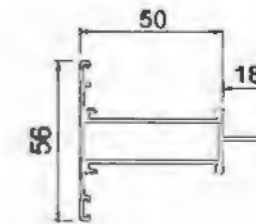

Mullion YLJ25003
T=1.4mm 0.81kg/m

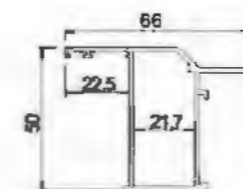

Frame YLJ25002CD
T=1.4mm 0.801kg/m

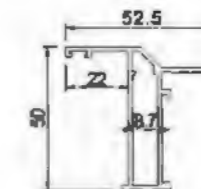

Frame YLJ25002B
T=1.4mm 0.69kg/m

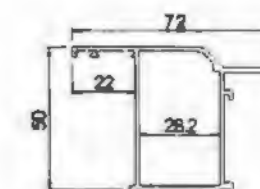

Frame YLJ25002CDA
T=1.4mm 0.844kg/m

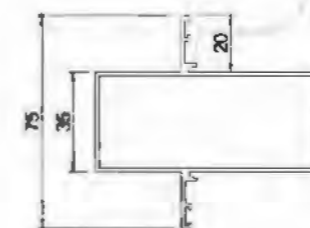

Strengthen Column YLJ25023X
T=1.35mm 1.134kg/m

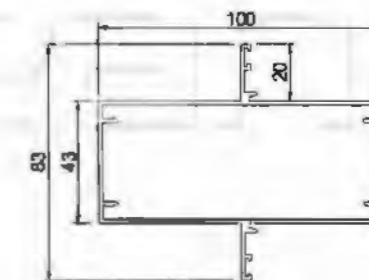

Strengthen Column YLJ25023A
T=1.4mm 1.423kg/m

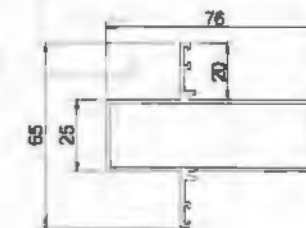

Column YLJ25023BA
T=1.4mm 1.037kg/m

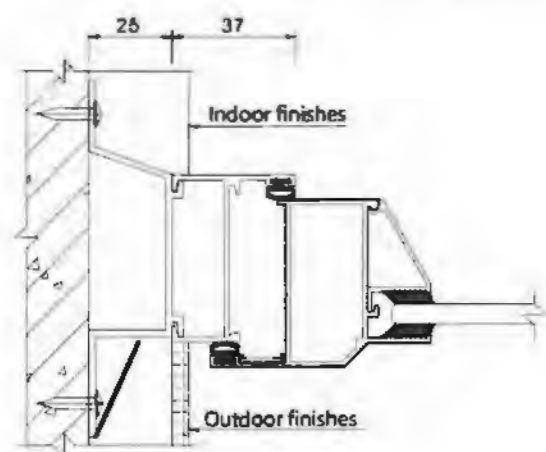

①

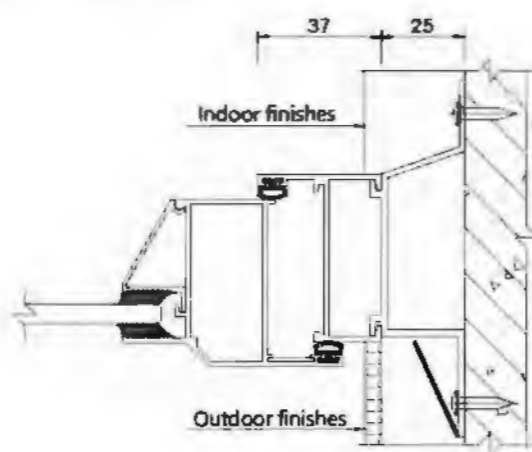

②

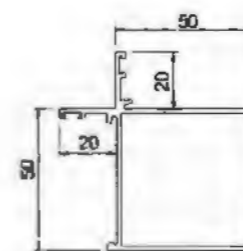

Inner Corner Frame YLJ25024P
T=1.5mm 1.076kg/m

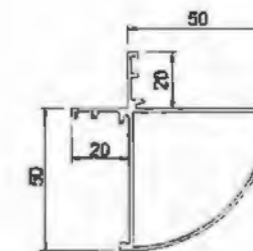

Inner Corner Frame YLJ25024D
T=1.35mm 0.865kg/m

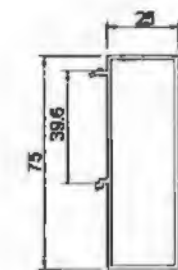

Connecting Tube YLJ25010C
T=1.4mm 0.839kg/m

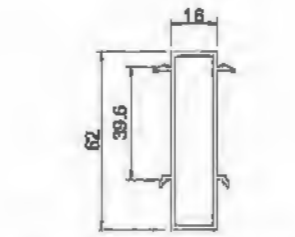
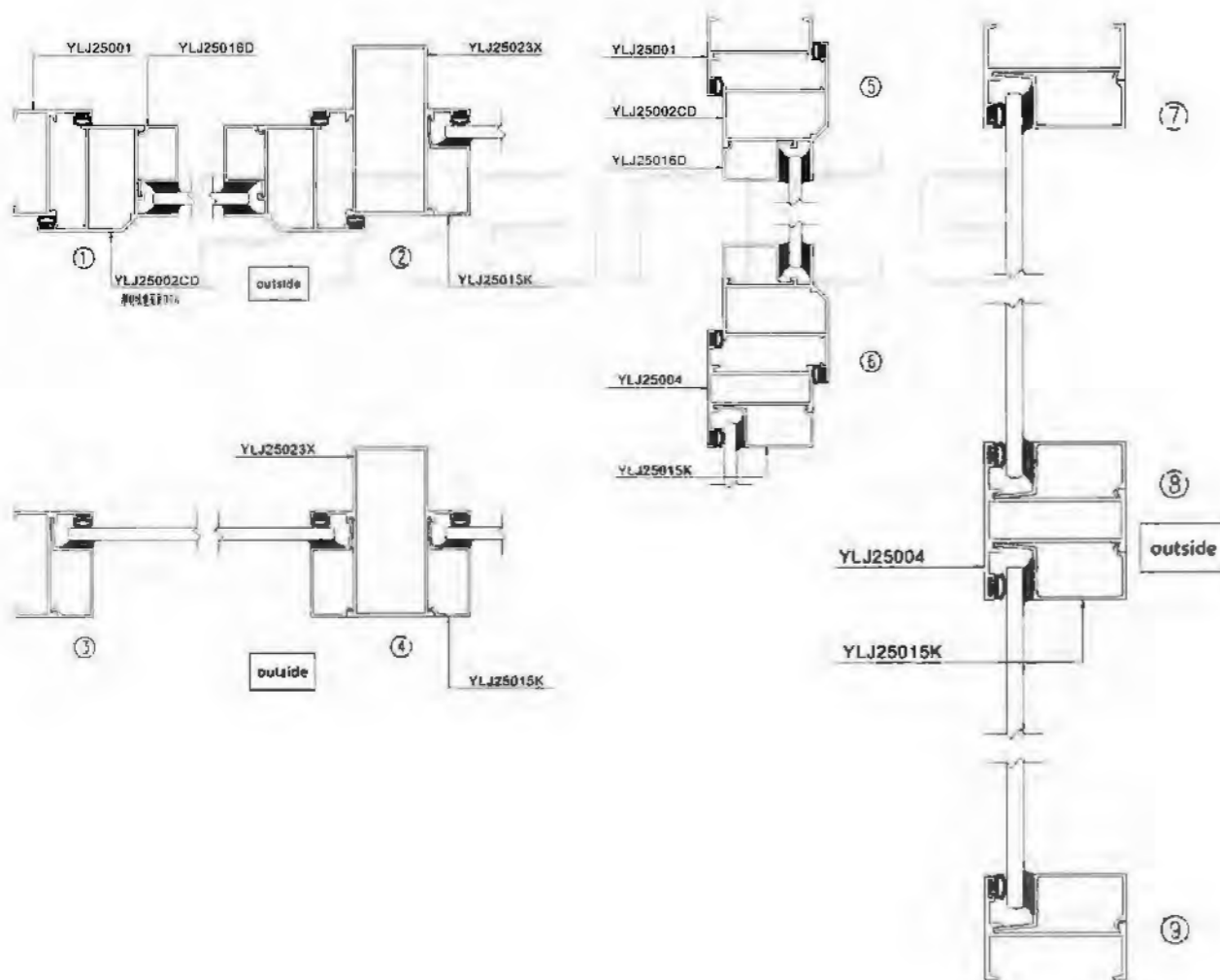
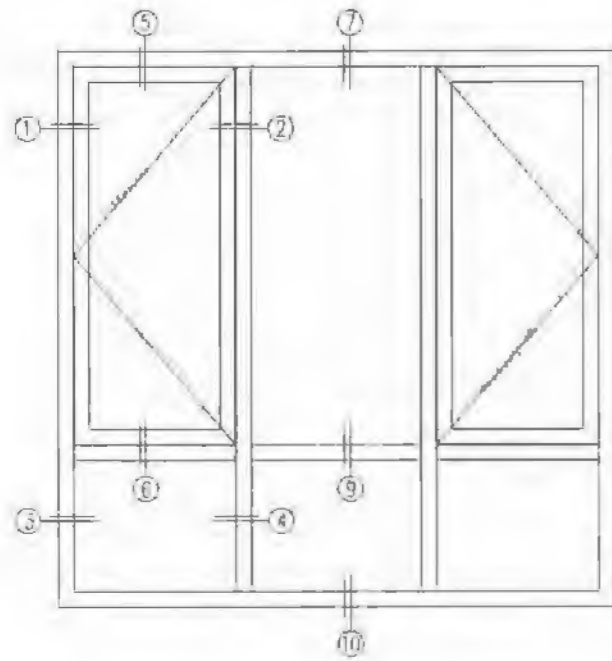

Connecting Tube YLJ25010T
T=1.4mm 0.67kg/m

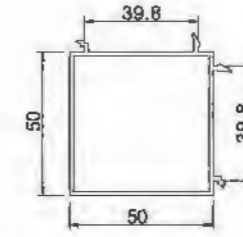

Corner Connecting Tube YLJ25011
T=1.4mm 0.85kg/m

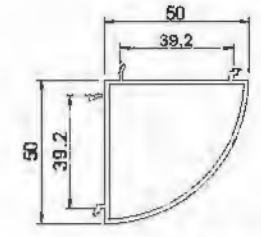

Corner Connecting Tube YLJ25011BT
T=1.4mm 0.742kg/m

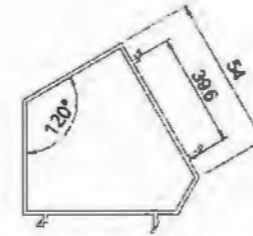

120°Corner Connecting Tube YLJ25018T
T=1.4mm 0.832kg/m

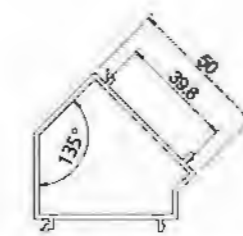

135°Corner Connecting Tube YLJ25018A
T=1.7mm 0.901kg/m

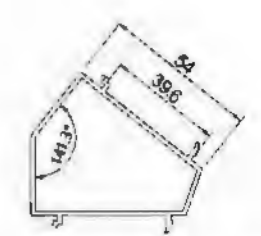

141°Corner Connecting Tube YLJ25055
T=1.4mm 0.827kg/m

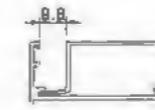

Frame Glass Bead YLJ25015H
T=1.0mm 0.254kg/m

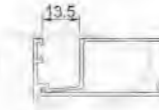

Frame Glass Bead YLJ25015K
T=1.0mm 0.253kg/m

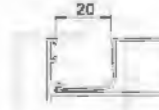

Frame Glass Bead YLJ25015A
T=1.0mm 0.245kg/m

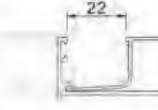

Frame Glass Bead YLJ25015R
T=1.0mm 0.245kg/m



Frame Glass Bead YLJ25015B
T=1.0mm 0.244kg/m

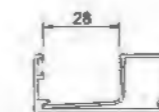

Frame Glass Bead YLJ25015J
T=1.0mm 0.243kg/m

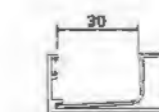

Frame Glass Bead YLJ25015M
T=1.0mm 0.241kg/m

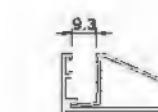

Frame Glass Bead YLJ25015
T=1.0mm 0.219kg/m

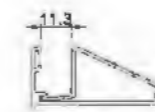

Frame Glass Bead YLJ25015C
T=1.0mm 0.22kg/m

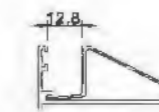

Frame Glass Bead YLJ25015G
T=1.0mm 0.19kg/m

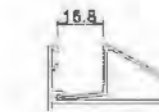

Frame Glass Bead YLJ25015F
T=1.0mm 0.22kg/m

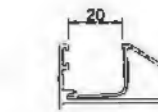

Frame Glass Bead YLJ25015D
T=1.0mm 0.235kg/m

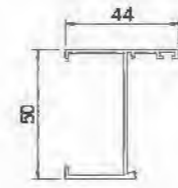
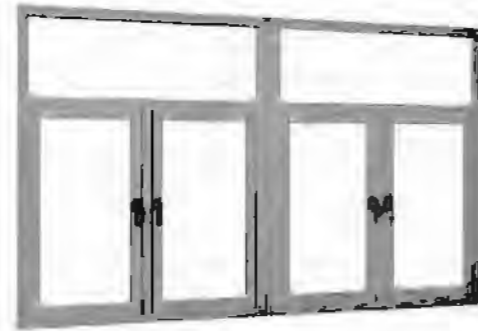
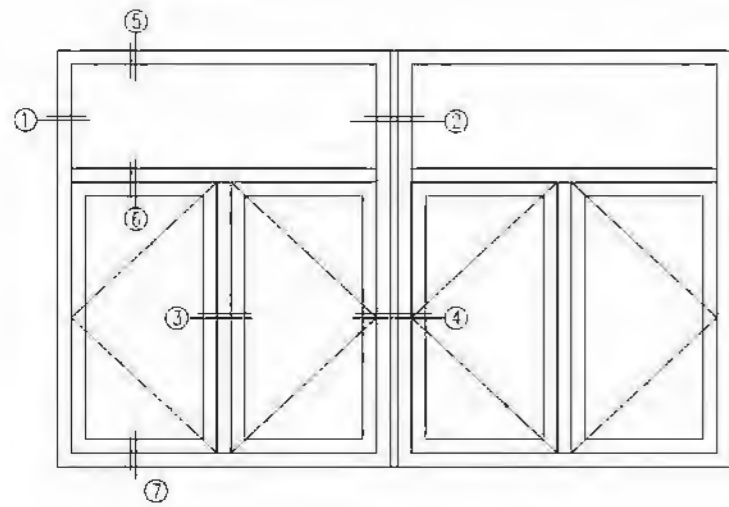

Frame P50A0314
T=1.4mm 0.507kg/m

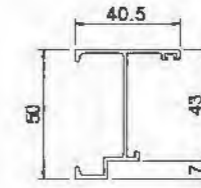

Frame P50A0314a
T=1.4mm 0.498kg/m

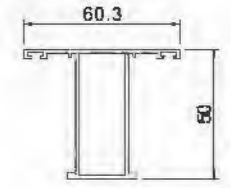

Mullion P50A0614
T=1.4mm 0.762kg/m

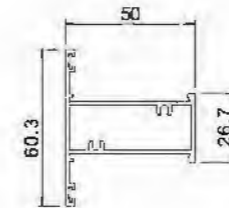

Mullion P50A3714
T=1.4mm 0.826kg/m

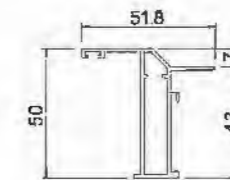

Frame P50A2714
T=1.4mm 0.669kg/m

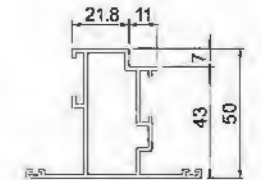

Frame P50C2814
T=1.4mm 0.877kg/m

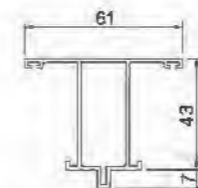

Double Open Mullion P50C0514
T=1.4mm 0.771kg/m

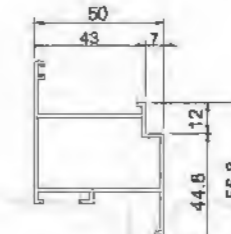

Reverse Mullion P50C2314
T=1.4mm 0.884kg/m

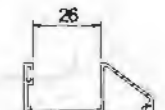

Hollow Glass Bead P50A6409
T=0.9mm 0.21kg/m

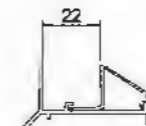

Hollow Open Glass Bead P50A2109
T=0.9mm 0.155kg/m

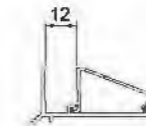

Single Glass Open Glass Bead P50A6709
T=0.9mm 0.152kg/m

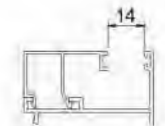

Single Glass Glass Bead P50C12A10
T=1.0mm 0.250kg/m

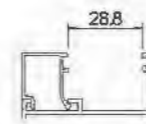

Hollow Glass Bead P50C13A10
T=1.0mm 0.192kg/m

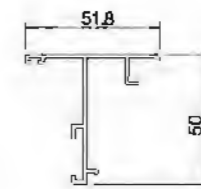

Frame Boarder Transfer Material P50C13A10
T=1.4mm 0.531kg/m

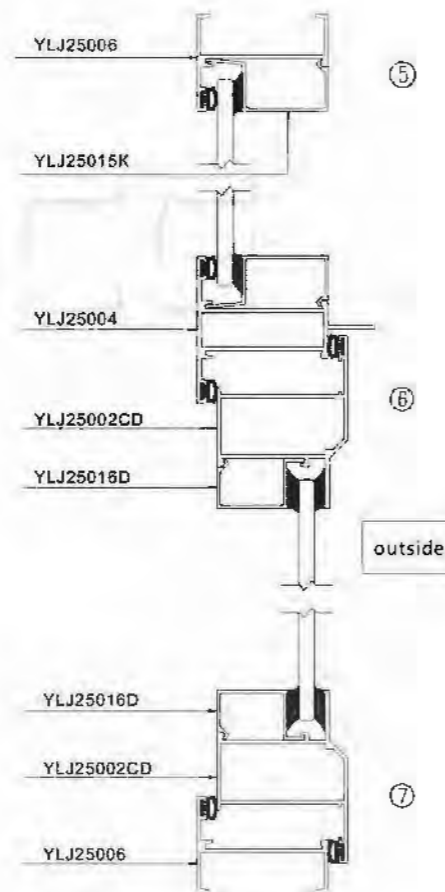
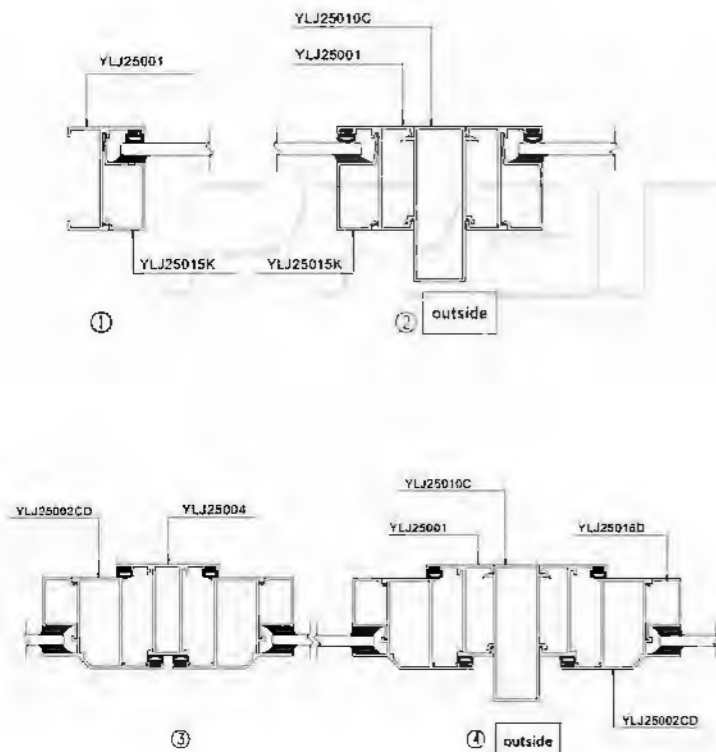

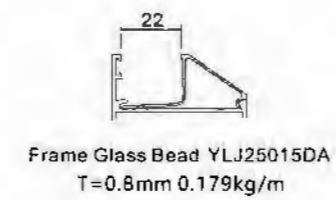
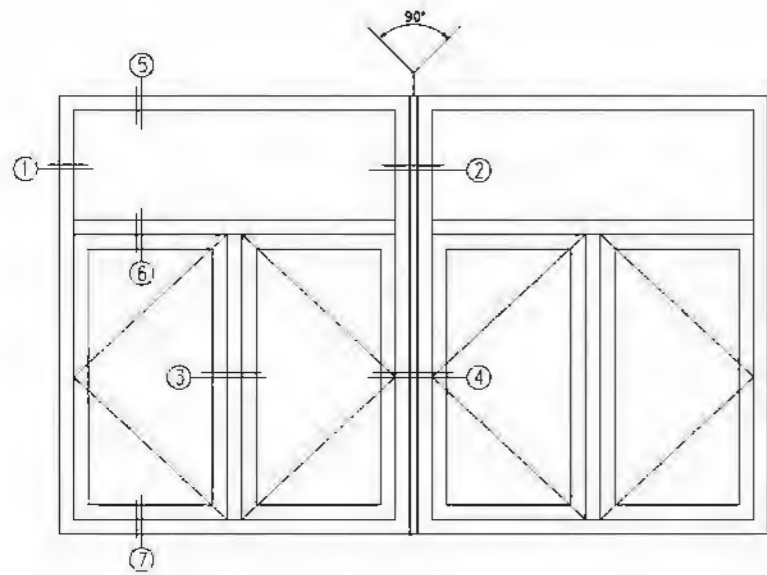

65

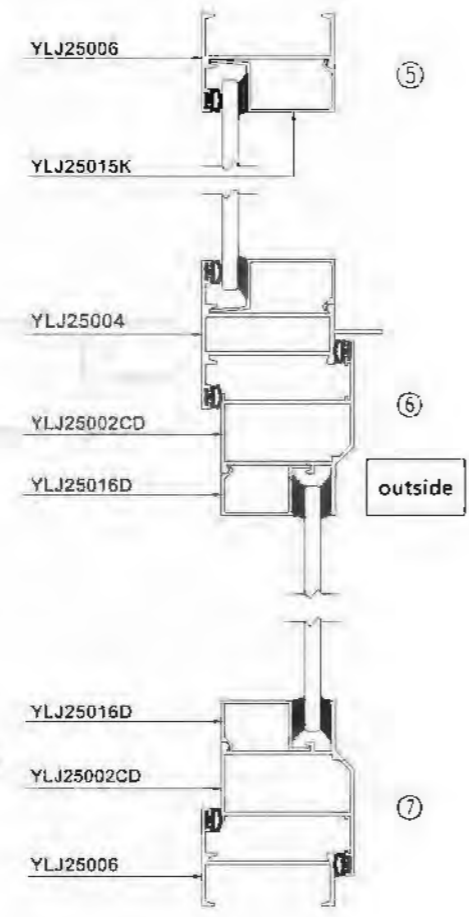
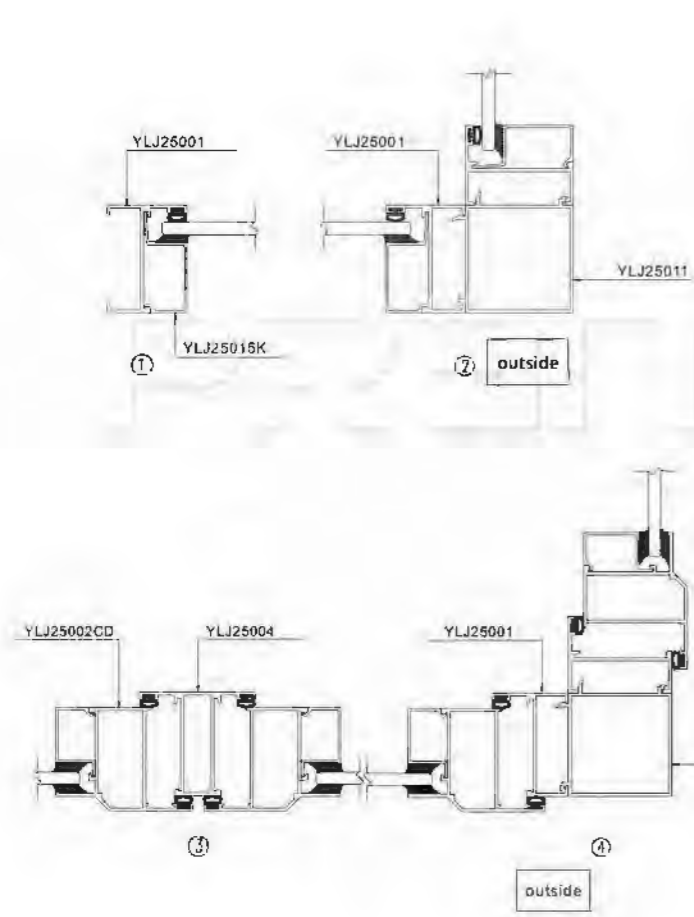

67

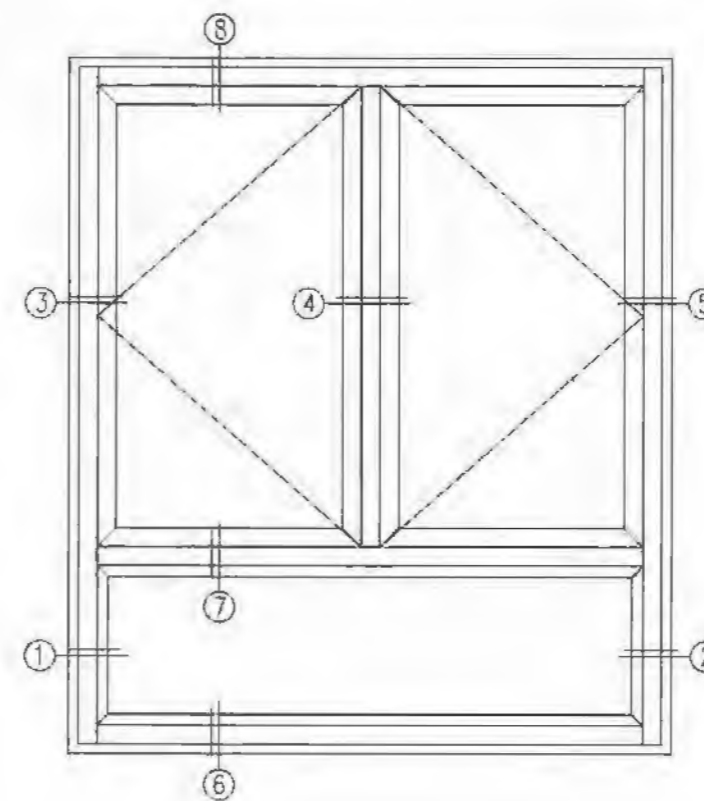
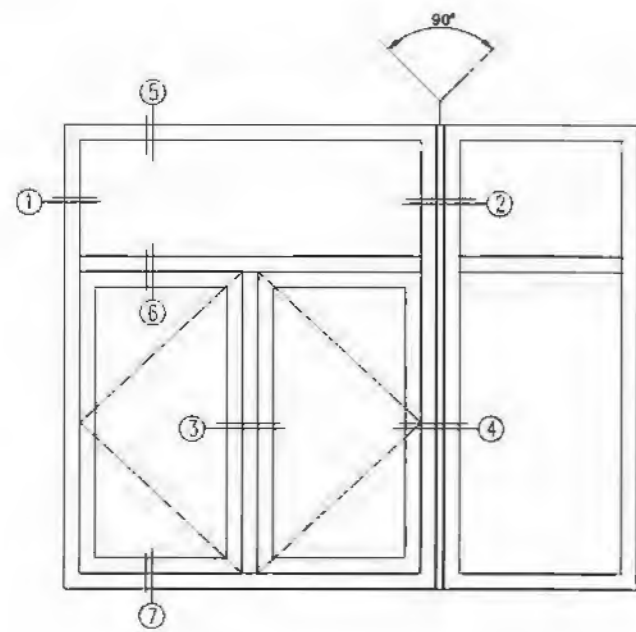

67

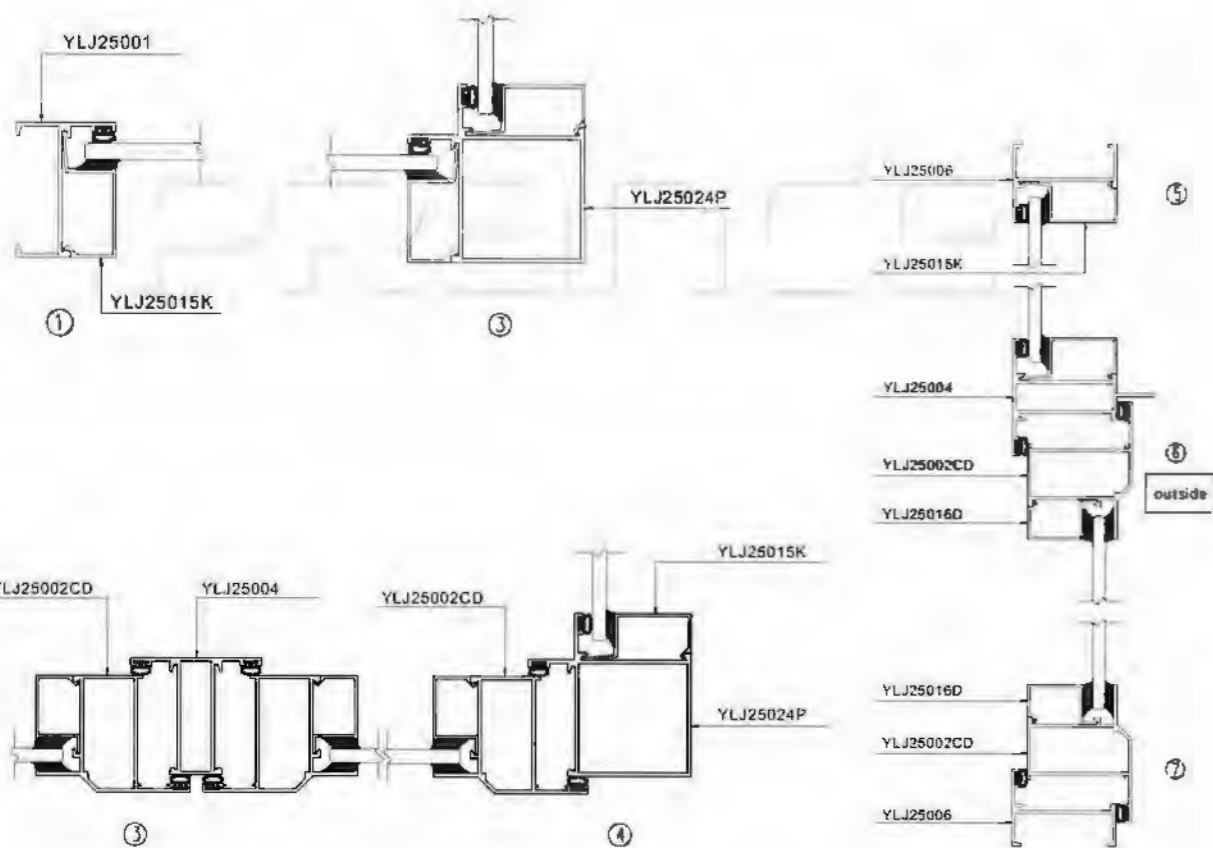

68

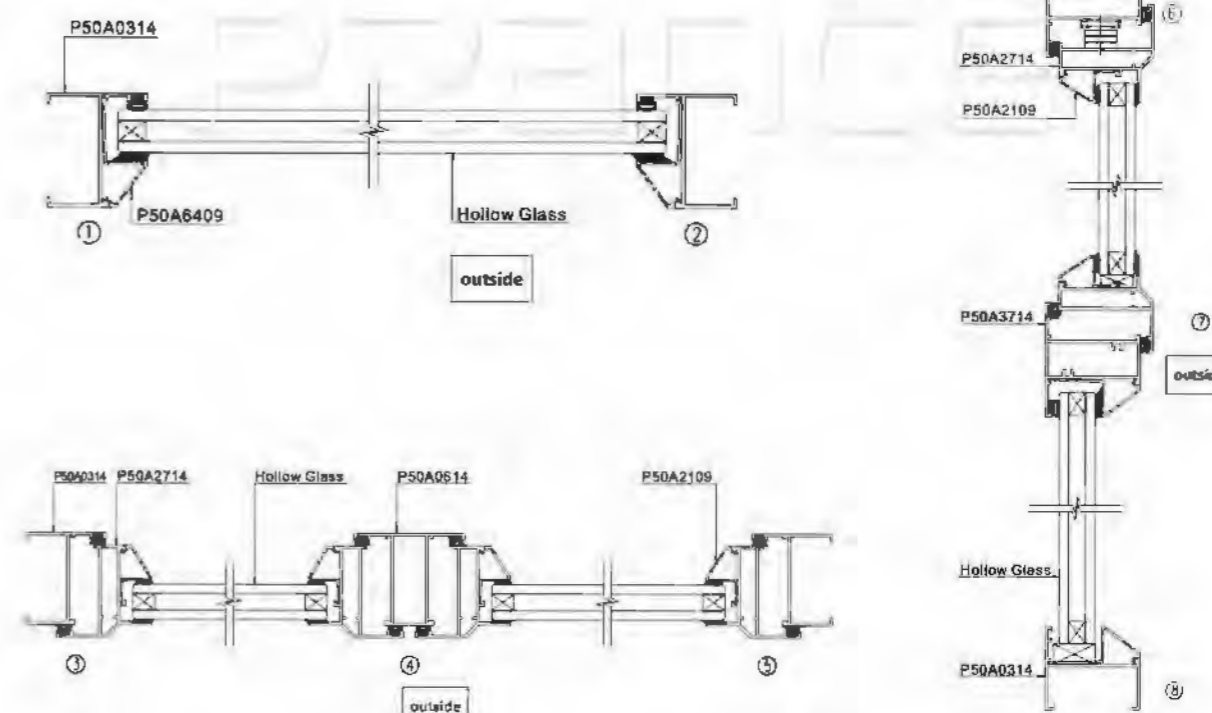

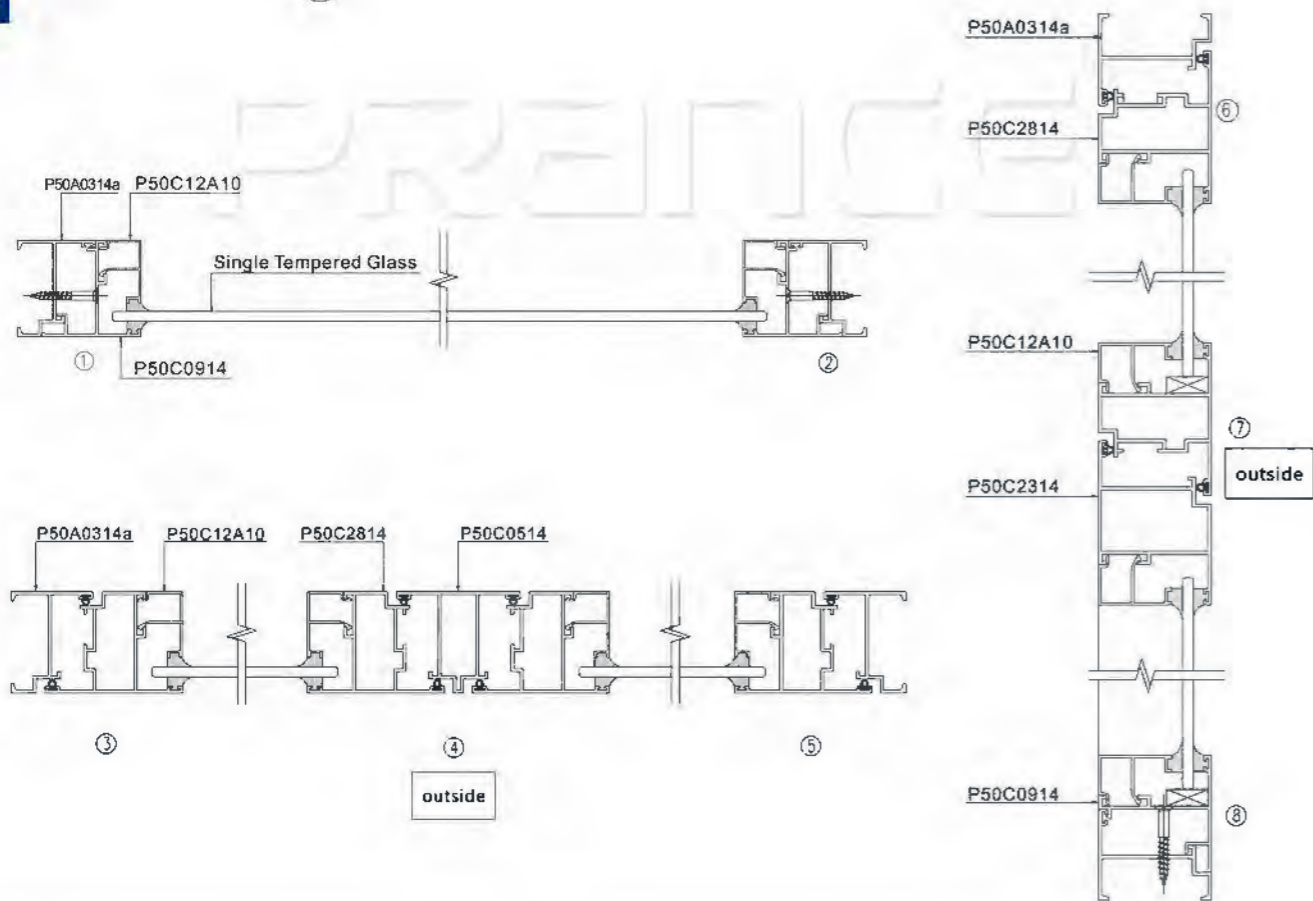
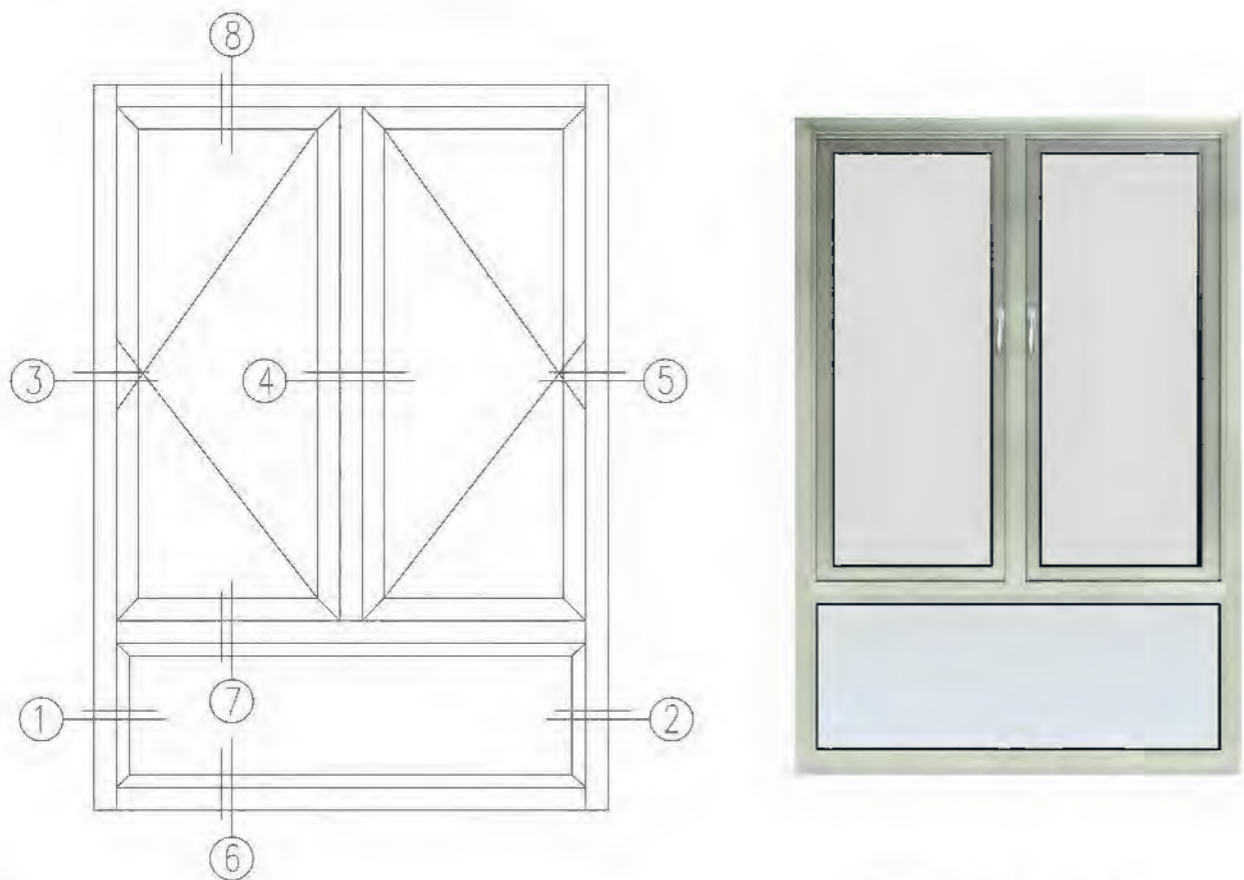

High sealing performance with simple structure, the sash can all be opened to facilitate ventilation.





SHOWING



The Open angle is large, improves ventilation. High sealing performance provides excellent sound insulation, thermal insulation, and impermeability.

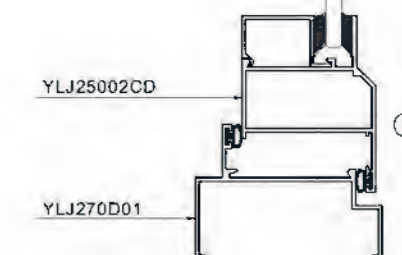
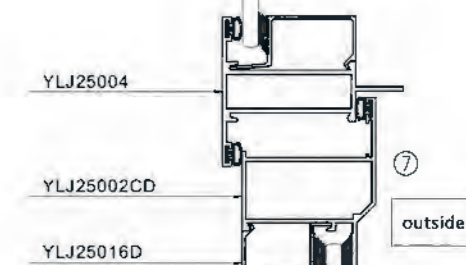
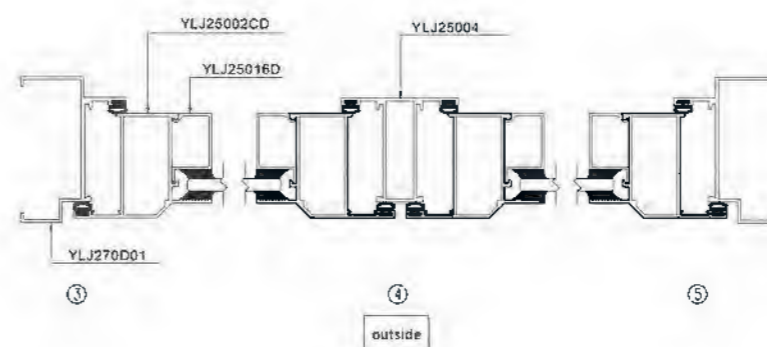
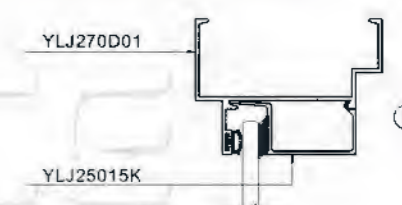
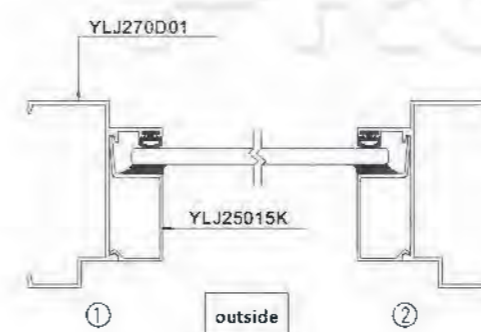
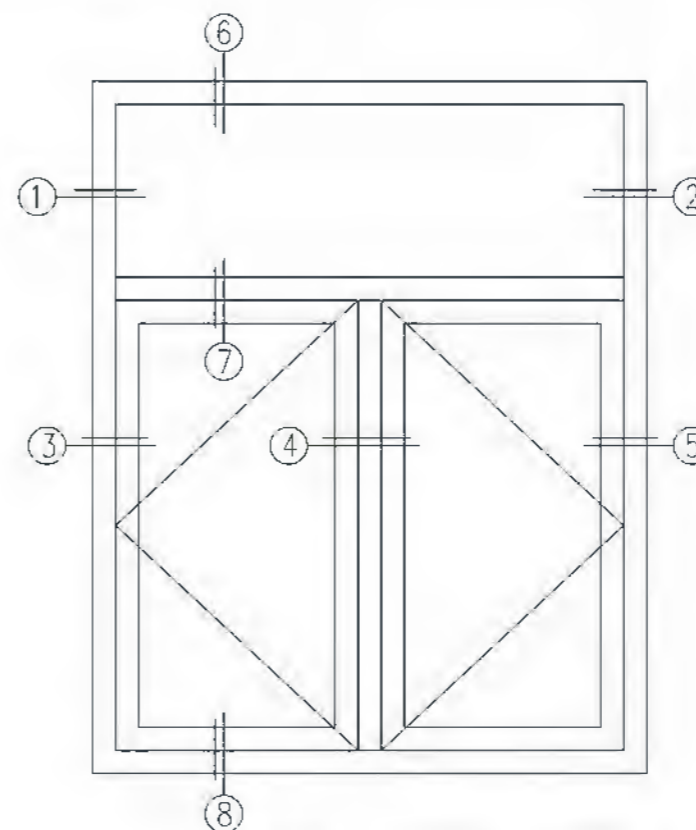

PRODUCT INSTRUCTION

Model: 70casement window
Surface Treatment: PVDF Coating; Powder Coating; Anodized; Electrophoretic Coating
Profile Thickness: Window: 1.4mm; Door: 2.0mm
Material of Profile: 6063/T5, 6063/T6
Glass Selection: Tempered Glass/Resective Coated Glass(5、6、8、10), Tempered Insulated Glass Units(5+9A+5、6+9A+6)
Hardware Selection: Chinese and German hardware are available(Kin Long, HeHe, Roto)
Applicable Range: Office Buildings, Residential, Villas, Apartments, Schools, Hospitals and other properties of the building envelope system

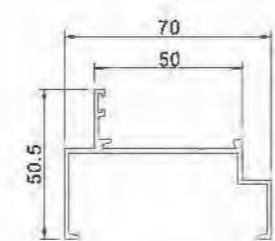
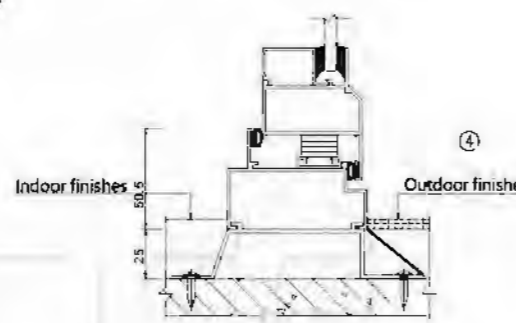
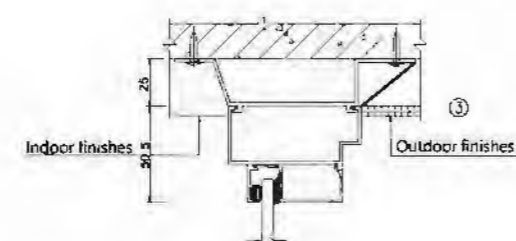
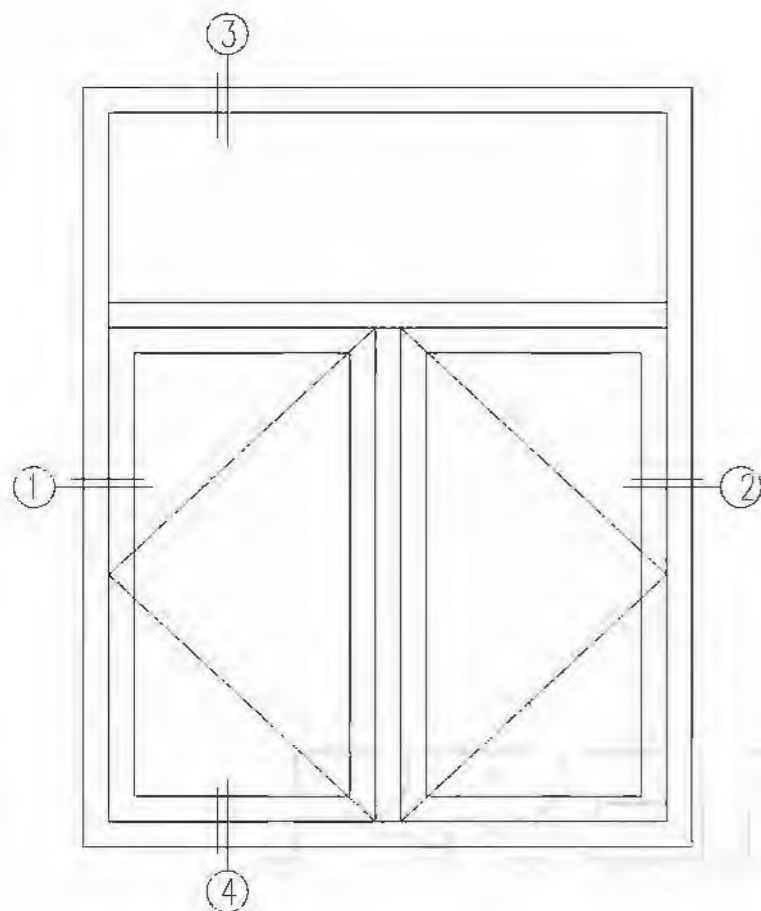

Frame YLJ270D1
T=1.4mm 0.662kg/m

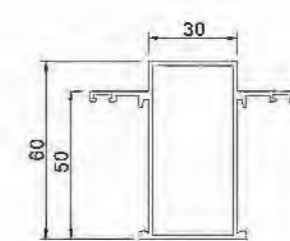

Column YLJ270D02
T=1.4mm 0.956kg/m

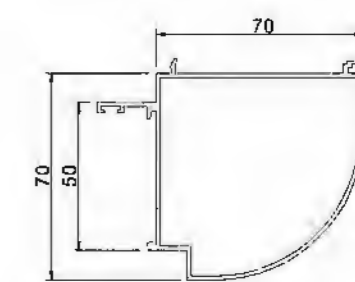

Corner Material YLJ270D03
T=1.35mm 1.123kg/m

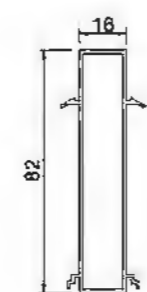

Connecting Tube YLJ27008
T=1.26mm 0.748kg/m

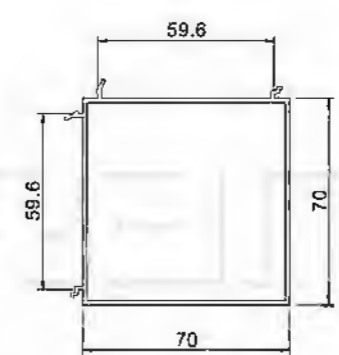

Corner Connecting Tube YLJ27007T
T=1.45mm 1.17kg/m

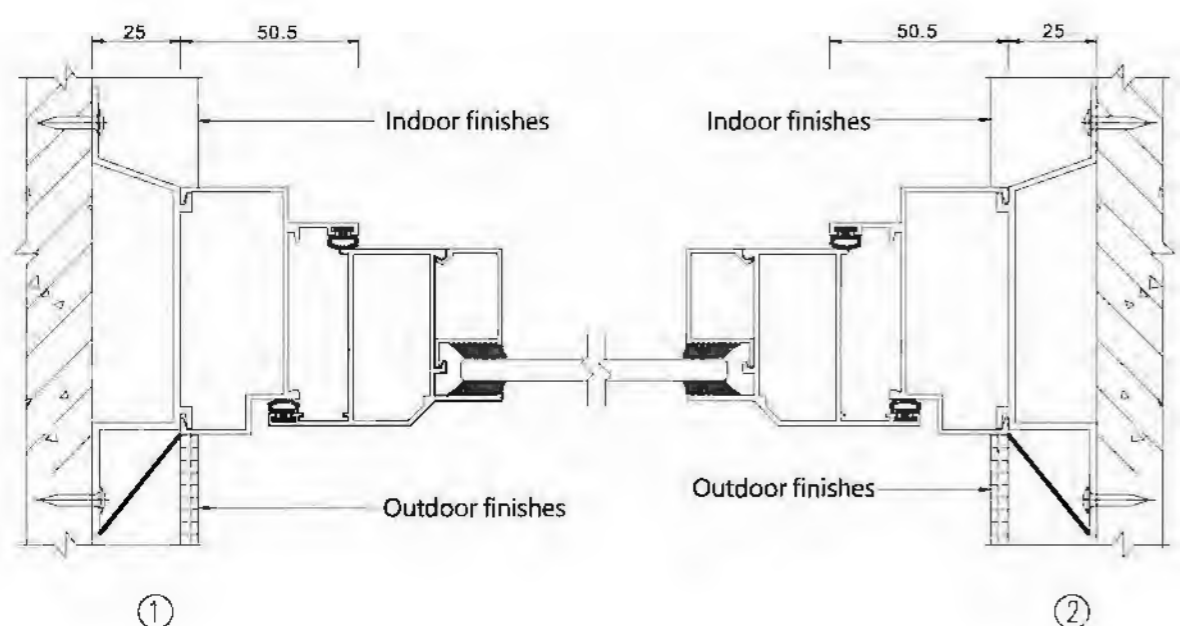

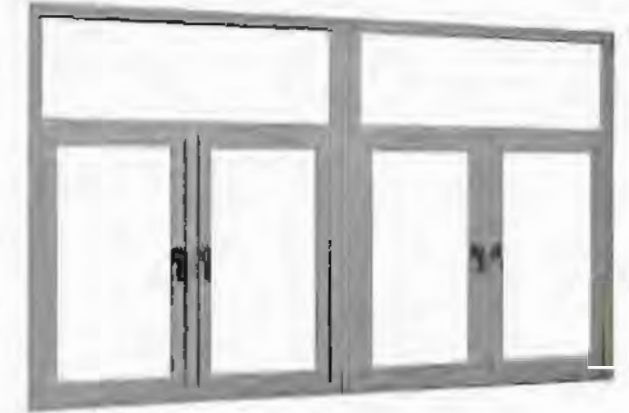
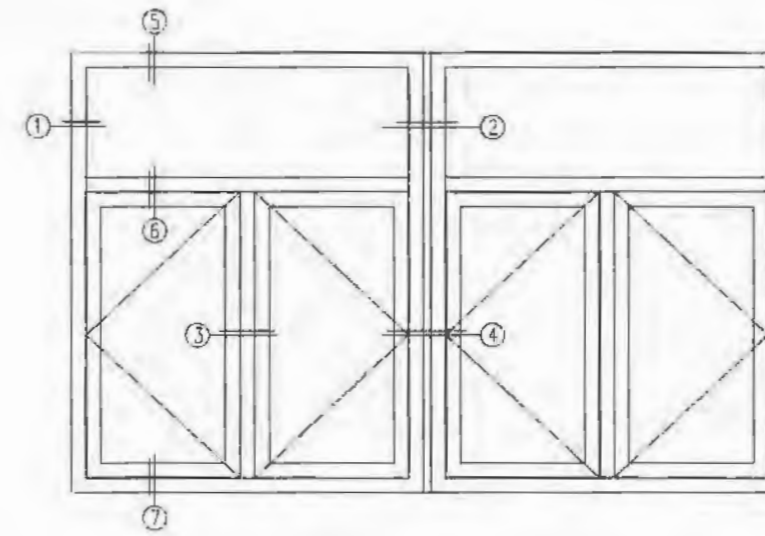
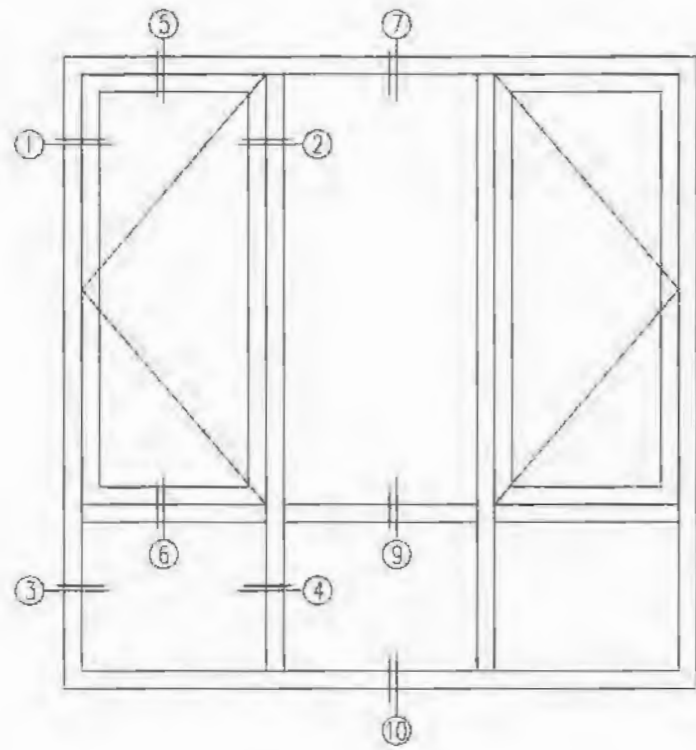

77

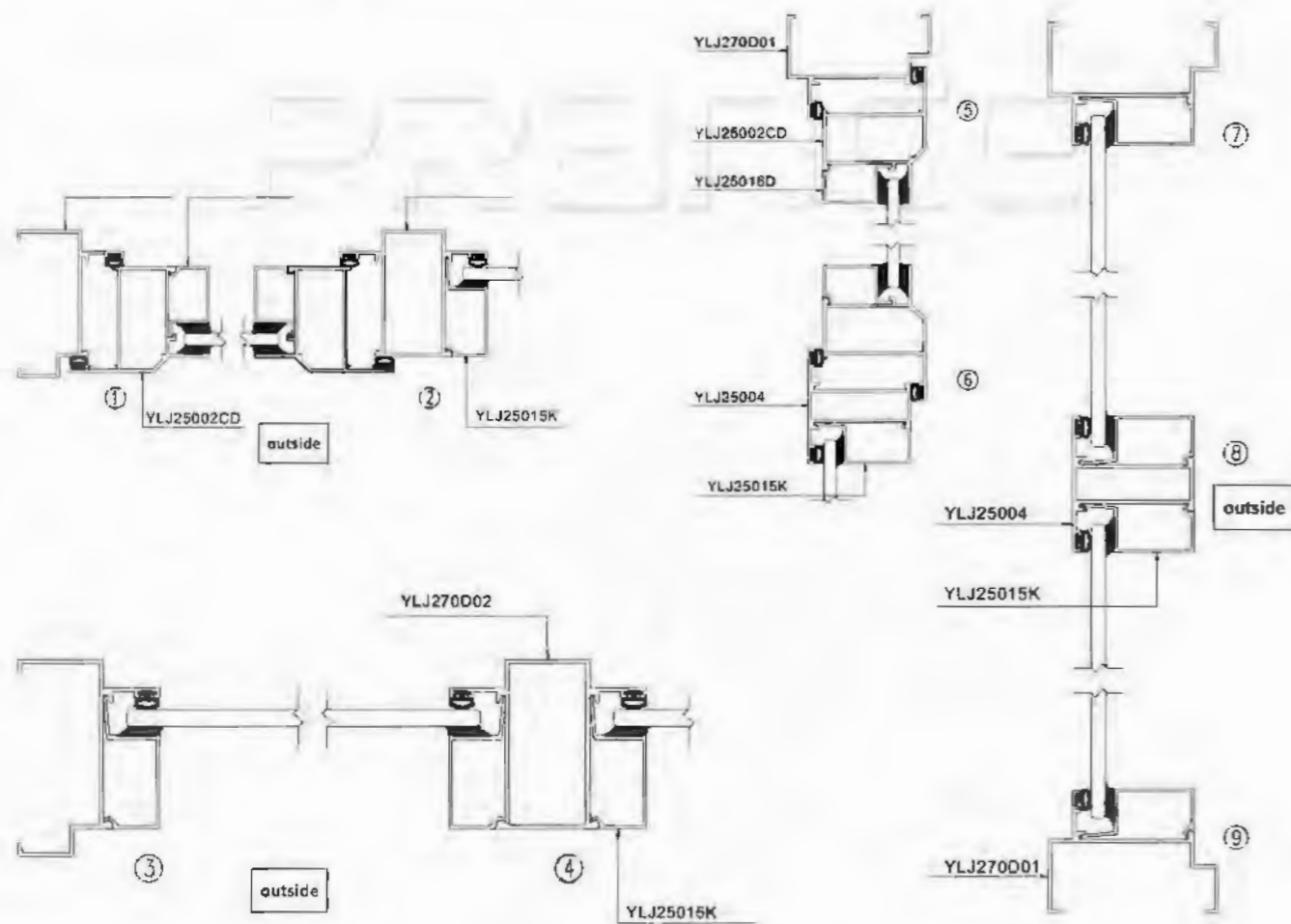

78

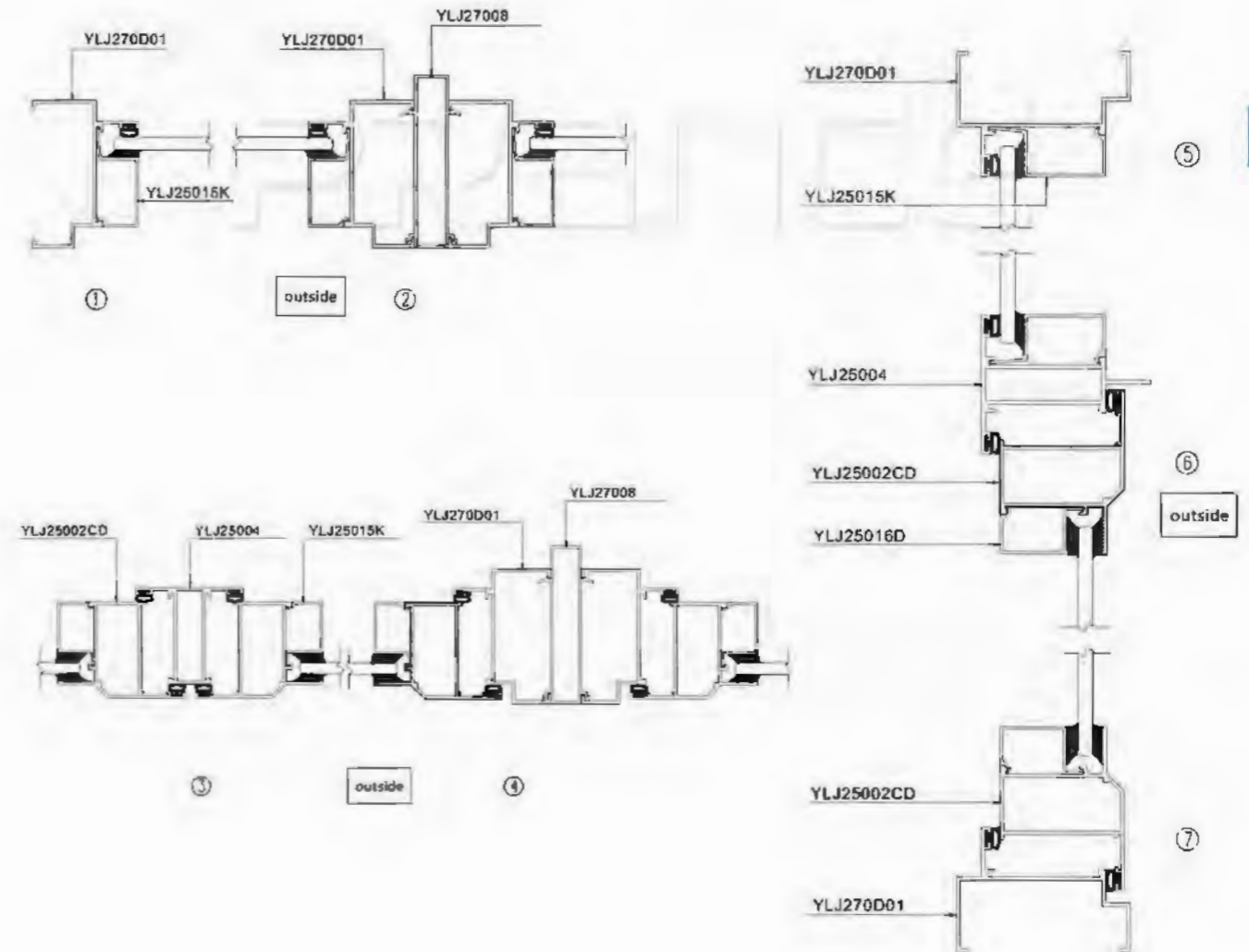



Outer casement window is high waterproof, and does not occupy the interior space when it opens; inside casement window is easy to be cleaned regularly.



SHOWING



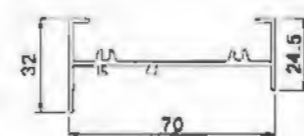
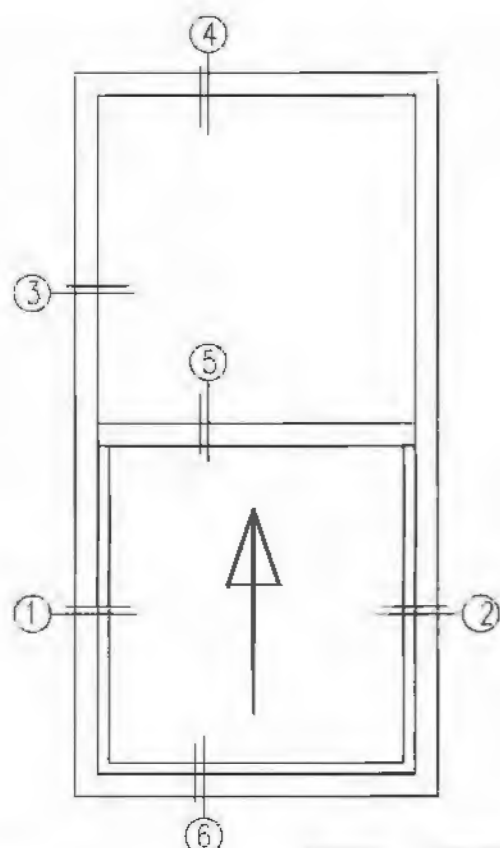

JHB7001
T=1.45mm 0.642kg/m

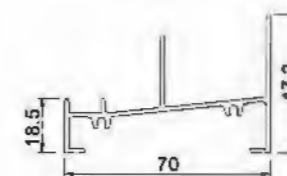

JHB7002
T=1.45mm 0.764kg/m

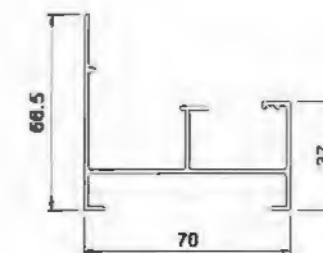

JHB7003A
T=1.45mm 0.886kg/m

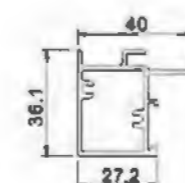

JHB7004
T=1.45mm 0.650kg/m

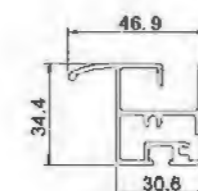

JHB7005
T=1.45mm 0.793kg/m

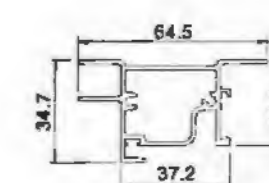

JHB7006
T=1.45mm 0.848kg/m

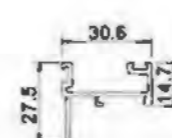
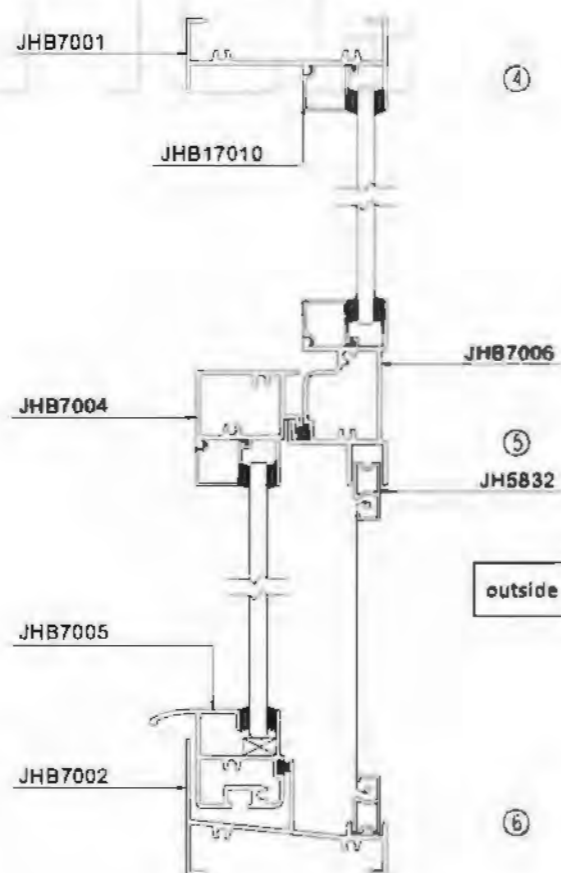
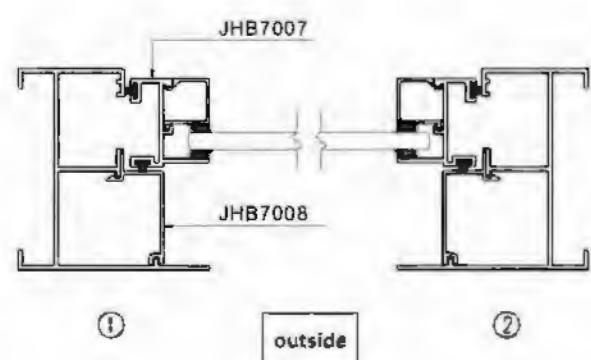
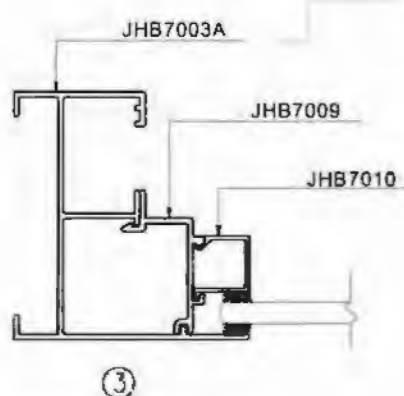

JHB7007
T=1.45mm 0.363kg/m

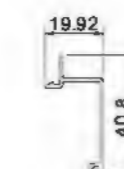

JHB7008
T=1.0mm 0.192kg/m



JHB7009
T=1.45mm 0.312kg/m

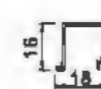

JHB7010
T=0.9mm 0.127kg/m

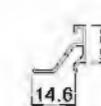

JHB7010A
T=0.9mm 0.114kg/m



JH5832
T=1mm 0.156kg/m



High sealing performance provides excellent sound insulation, thermal insulation, and impermeability.



SHOWING



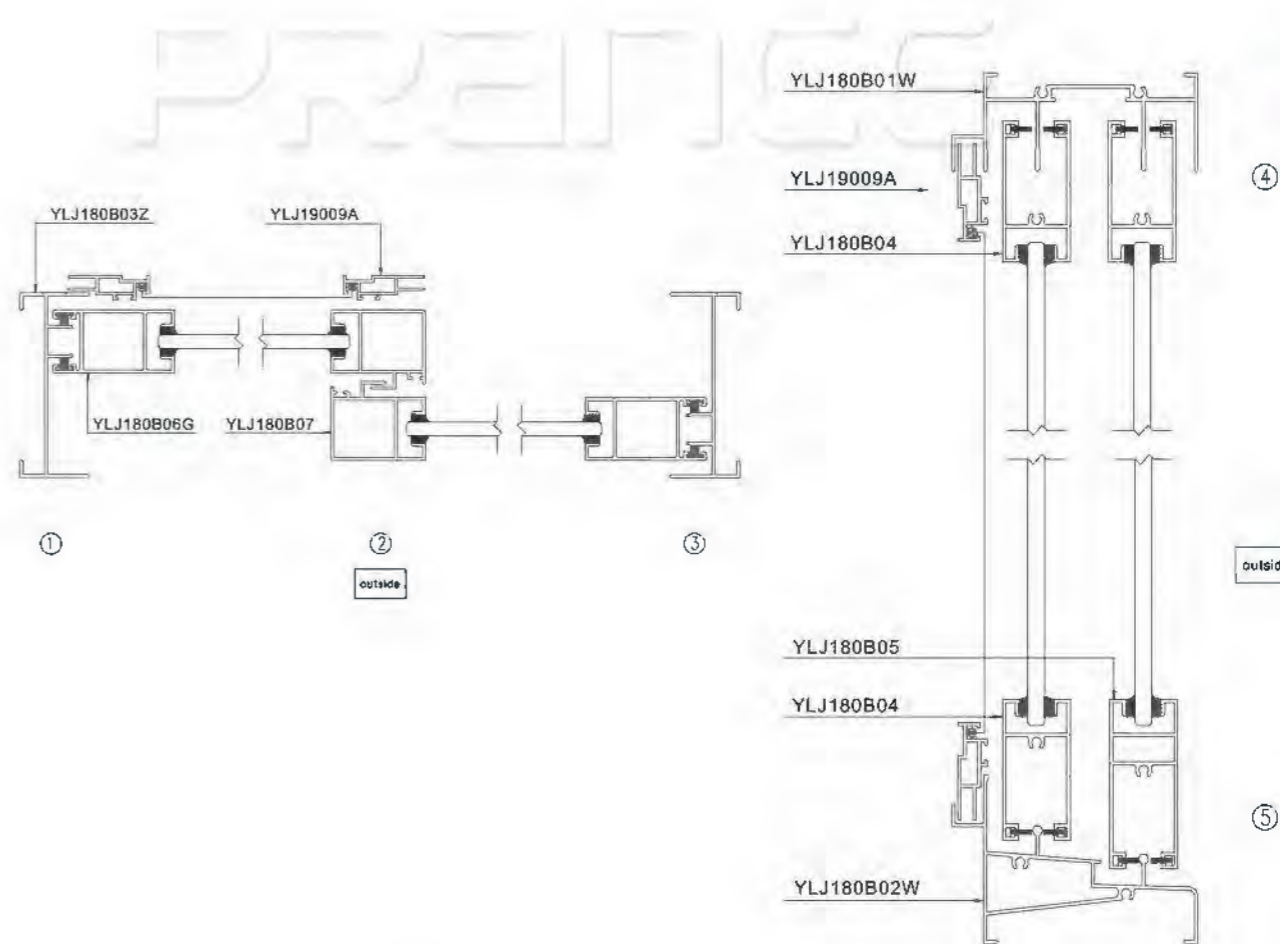
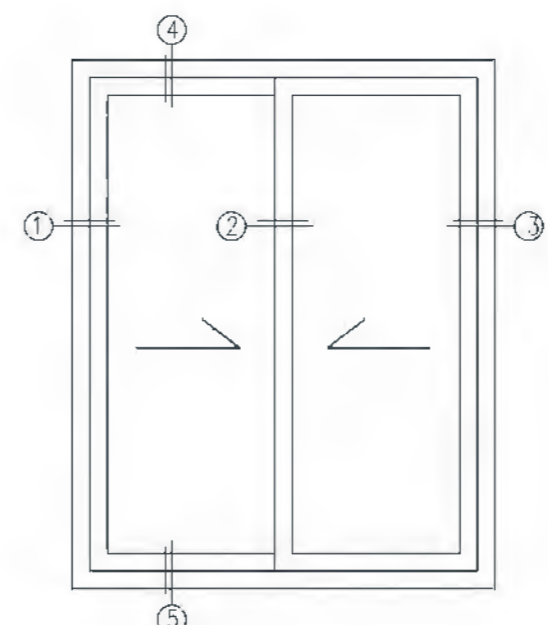

PRODUCT INSTRUCTION

Model: 70casement window
Surface Treatment: PVDF Coating; Powder Coating; Anodized; Electrophoretic Coating
Profile Thickness: Window: 1.4mm; Door: 2.0mm
Material of Profile: 6063/T5, 6063/T6
Glass Selection: Tempered Glass/Resective Coated Glass(5、6、8、10), Tempered Insulated Glass Units(5+9A+5、6+9A+6)
Hardware Selection: Chinese and German hardware are available(Kin Long、HeHe、Roto)
Applicable Range: Factory, Dormitories and other properties of the building envelope system.

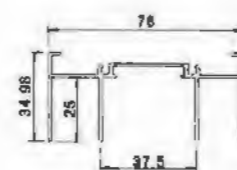
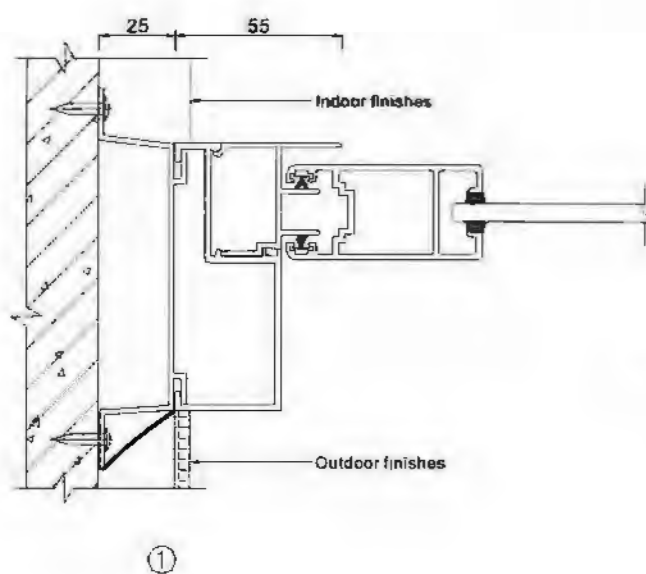
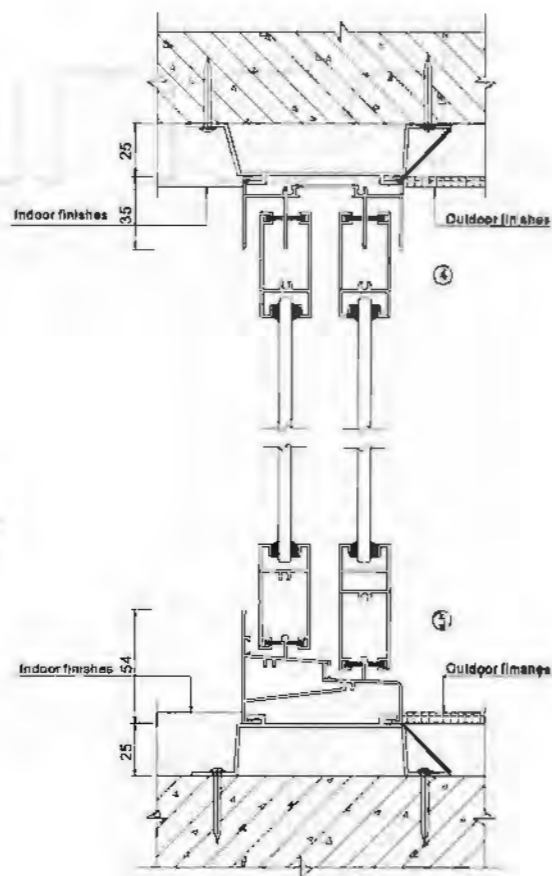
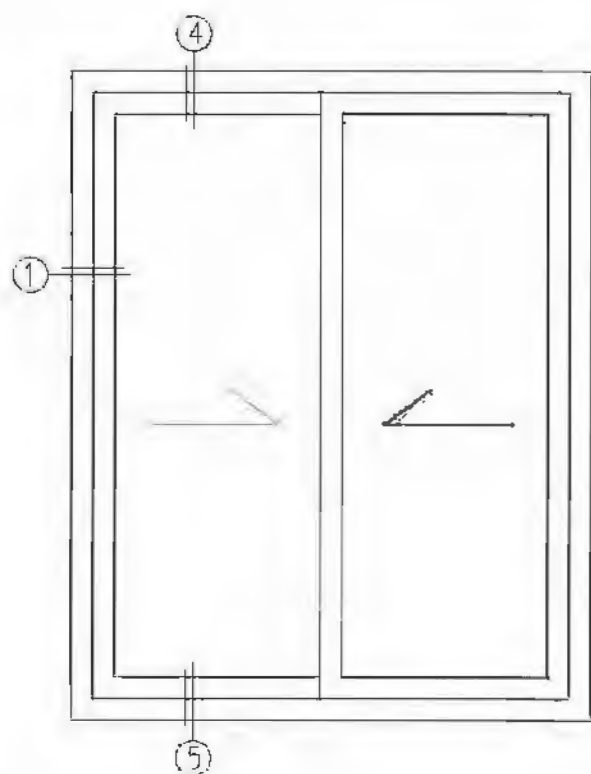

Upper Rail YLJ180B01
T=1.2mm 0.746kg/m

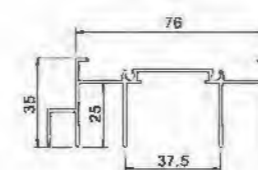

Upper Rail YLJ180B01W
T=1.2mm 0.828kg/m

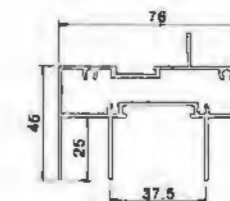

Middle Upper Rail
YLJ180B01A
T=1.2mm 1.163kg/m

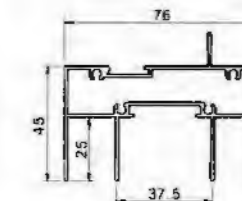

Middle Upper Rail(hollow)
YLJ180B01AZK
T=1.2mm 1.165kg/m

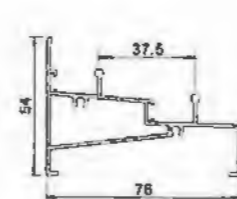

Bottom Rail YLJ180B02
T=1.2mm 0.89kg/m

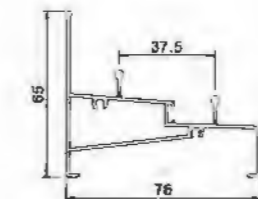

Bottom Rail YLJ180B02C
T=1.2mm 0.91kg/m

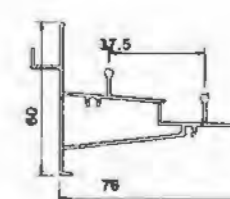

Bottom Rail YLJ180B02W
T=1.2mm 0.944kg/m

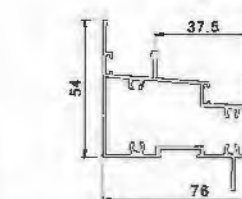

Middle Bottom Rail
YLJ180B02A
T=1.2mm 1.101kg/m

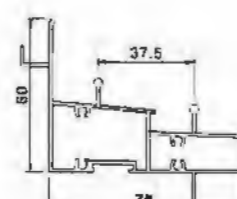

Middle Lower Rail
YLJ180B02WA
T=1.2mm 1.162kg/m

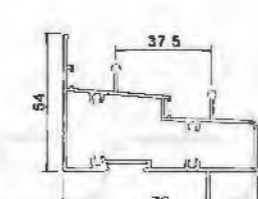

Middle Lower Rail(hollow)
YLJ180B02AZK
T=1.2mm 1.193kg/m

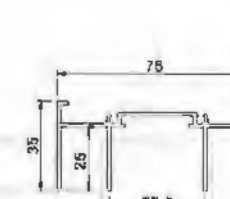

Upper Rail YLJ180B01T
T=1.4mm 0.831kg/m

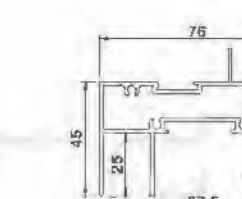

Middle Upper Rail
YLJ180B01AT
T=1.4mm 1.329kg/m

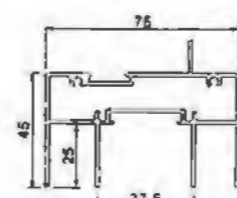

Middle Upper Rail(hollow)
YLJ180B01ATZK
T=1.4mm 1.1229kg/m

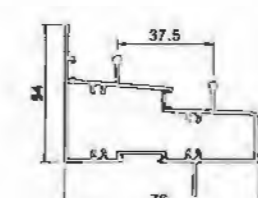

Middle Lower Rail
YLJ180B02AT
T=1.4mm 1.198kg/m

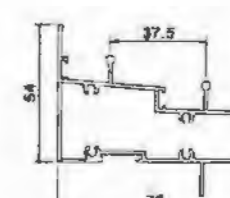

Middle Lower Rail
YLJ180B02ATZK
T=1.4mm 1.190kg/m

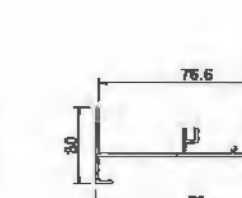

Edge YLJ180B03
T=1.2mm 0.561kg/m

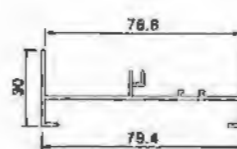

Edge YLJ180B03T
T=1.4mm 0.634kg/m

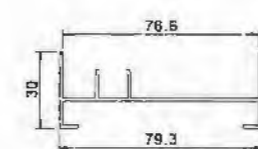

Edge YLJ180B03Z
T=1.35mm 0.62kg/m

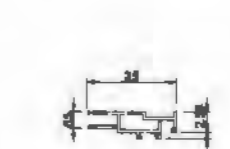

Window Screen
YLJ19009A
T=1.1mm 0.272kg/m



Window Screen
YLJ180E09
T=0.8mm 0.223kg/m

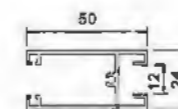
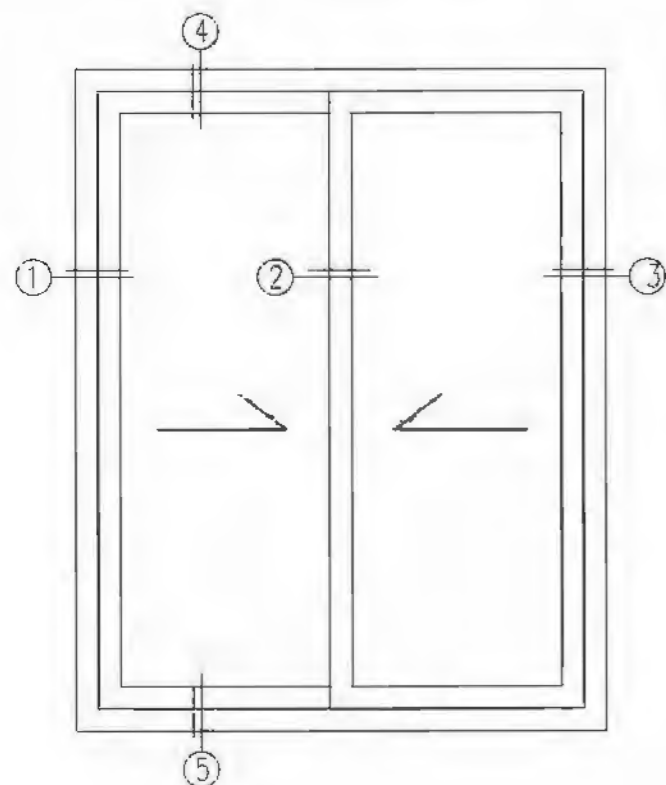

Above YLJ180B04
T=1.2mm 0.562kg/m

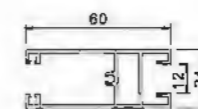

Below YLJ180B05
T=1.2mm 0.698kg/m

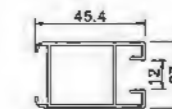

Lighting Frame
YLJ180B06
T=1.2mm 0.548kg/m

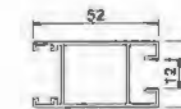

Lighting Frame
YLJ180B06G
T=1.25mm 0.642kg/m

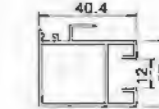

Hook Frame
YLJ180B07
T=1.2mm 0.585kg/m

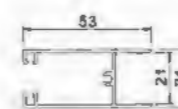

Above YLJ180B04ZK
T=1.2mm 0.521kg/m



Below YLJ180B05ZK
T=1.2mm 0.658kg/m

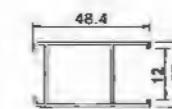

Lighting Frame
YLJ180B06ZK
T=1.2mm 0.504kg/m

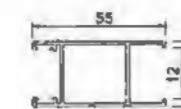

Lighting Frame
YLJ180B06GZK
T=1.2mm 0.58kg/m

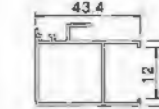

Hook Frame
YLJ180B07ZK
T=1.2mm 0.54kg/m

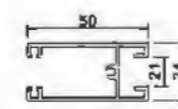

Above YLJ180B04T
T=1.4mm 0.628kg/m

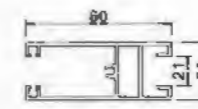

Below YLJ180B05T
T=1.4mm 0.785kg/m

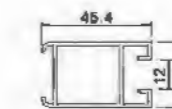

Lighting Frame
YLJ180B06T
T=1.4mm 0.626kg/m

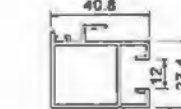

Hook Frame
YLJ180B07T
T=1.4mm 0.668kg/m

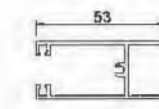

Above YLJ180B04TZK
T=1.4mm 0.592kg/m

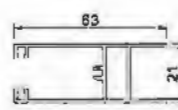

Below YLJ180B05TZK
T=1.4mm 0.746kg/m

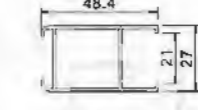

Lighting Frame
YLJ180B06TZK
T=1.4mm 0.593kg/m



Hook Frame
YLJ180B07TZK
T=1.4mm 0.624kg/m



Close-up Material
YLJ180B08A
T=1.4mm 0.238kg/m

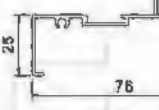

Above YLJ180B010
T=1.2mm 0.564kg/m



Above YLJ180B010ZK
T=1.2mm 0.564kg/m

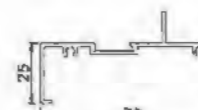

Above YLJ180B010T
T=1.4mm 0.638kg/m

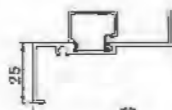

Above YLJ180B010TZK
T=1.4mm 0.628kg/m

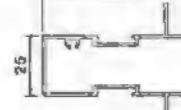

Middle YLJ180B013
T=1.2mm 0.857kg/m

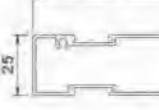

Middle YLJ180B013ZK
T=1.2mm 0.859kg/m

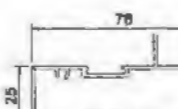

Middle YLJ180B013T
T=1.4mm 0.963kg/m

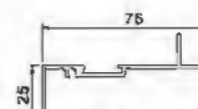

Middle YLJ180B013TZK
T=1.4mm 0.961kg/m

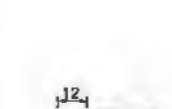

Fixed Glass Bead
YLJ180B019
T=0.9mm 0.178kg/m



Fixed Glass Bead
YLJ180B019ZK
T=0.9mm 0.144kg/m



Fixed Glass Bead
YLJ23800
T=0.9mm 0.128kg/m

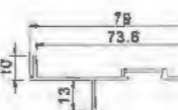

Frame Buckle Cover
YLJ180B11
T=1.2mm 0.394kg/m

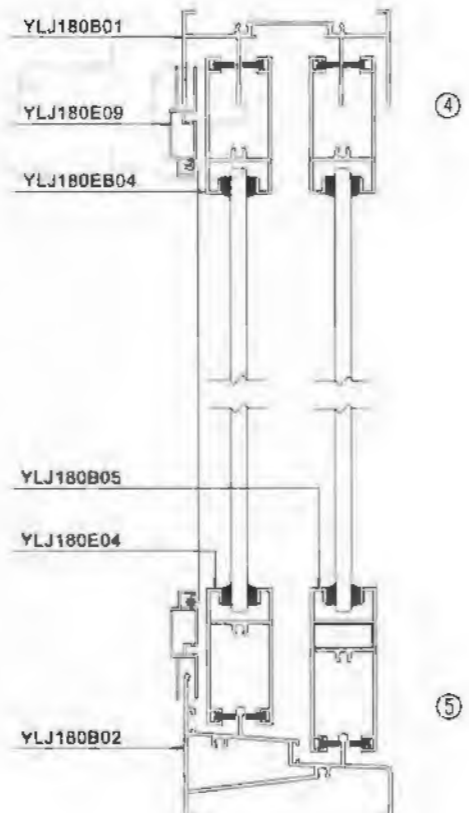
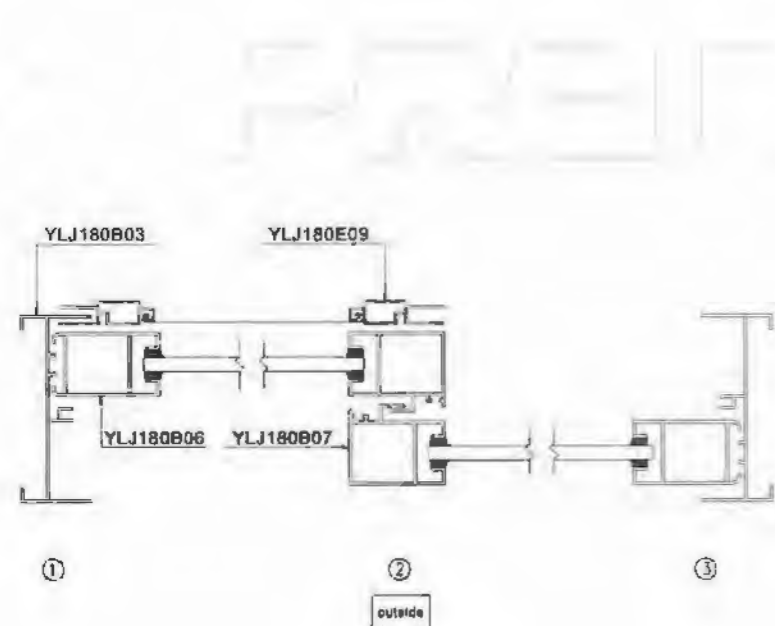

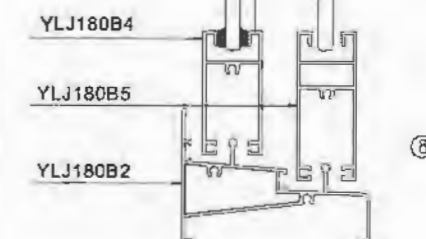
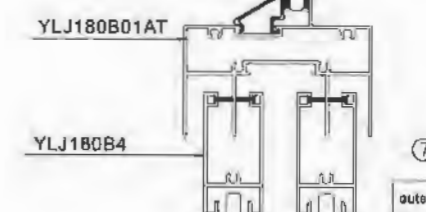
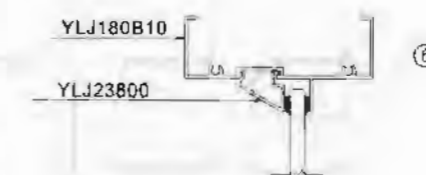
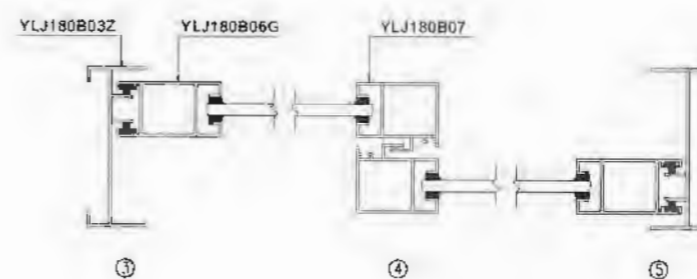
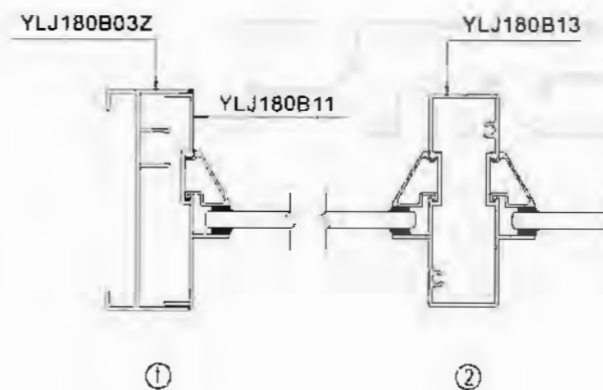
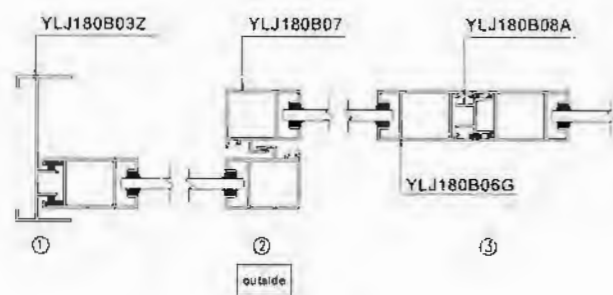
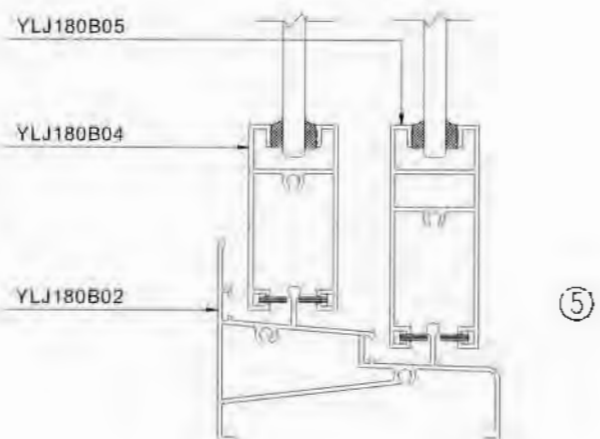
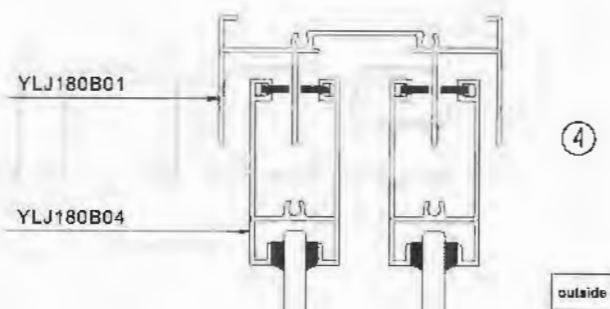
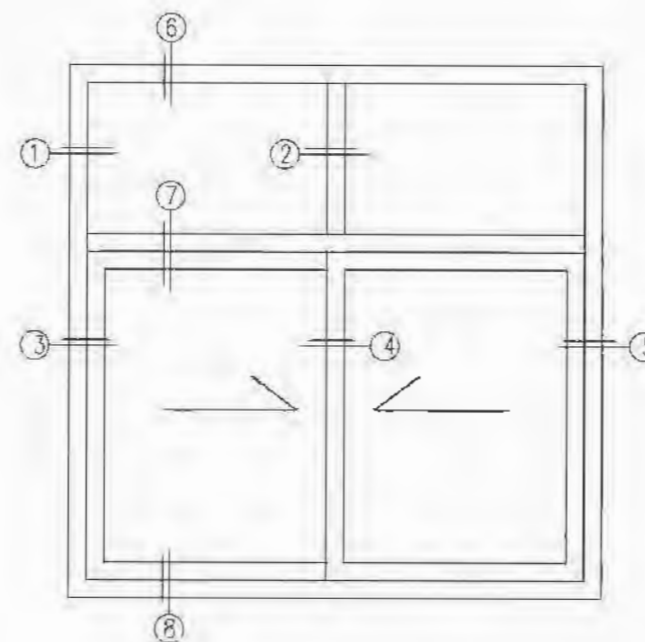
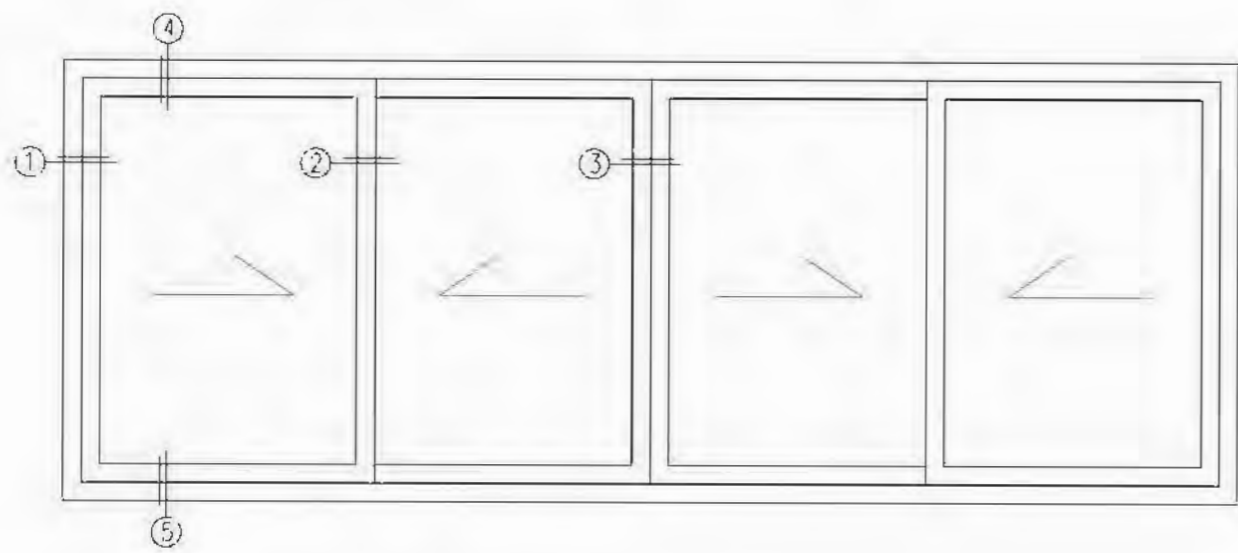



Take up less interior space, the appearance is beautiful, price is affordable, sealing performance is good.

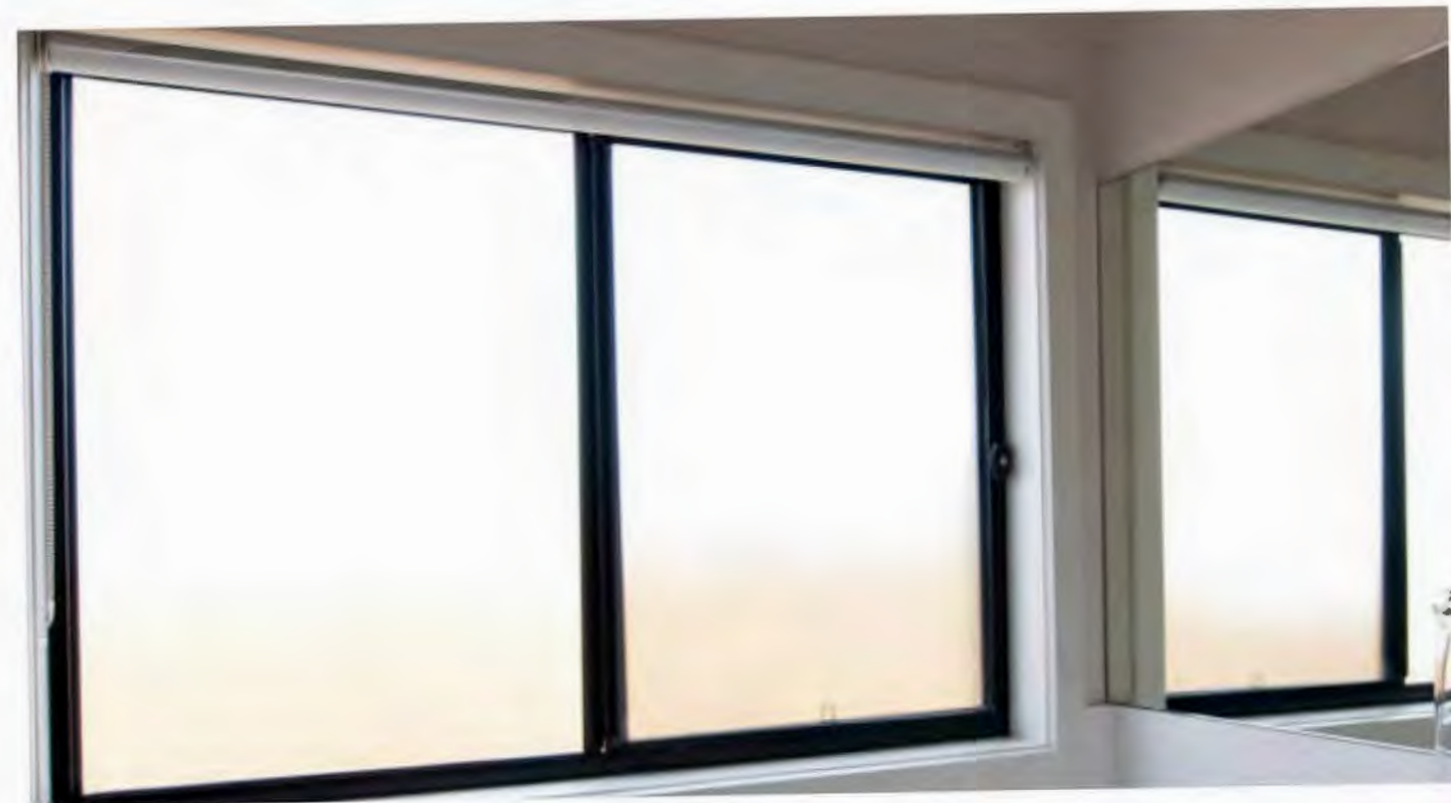

SHOWING



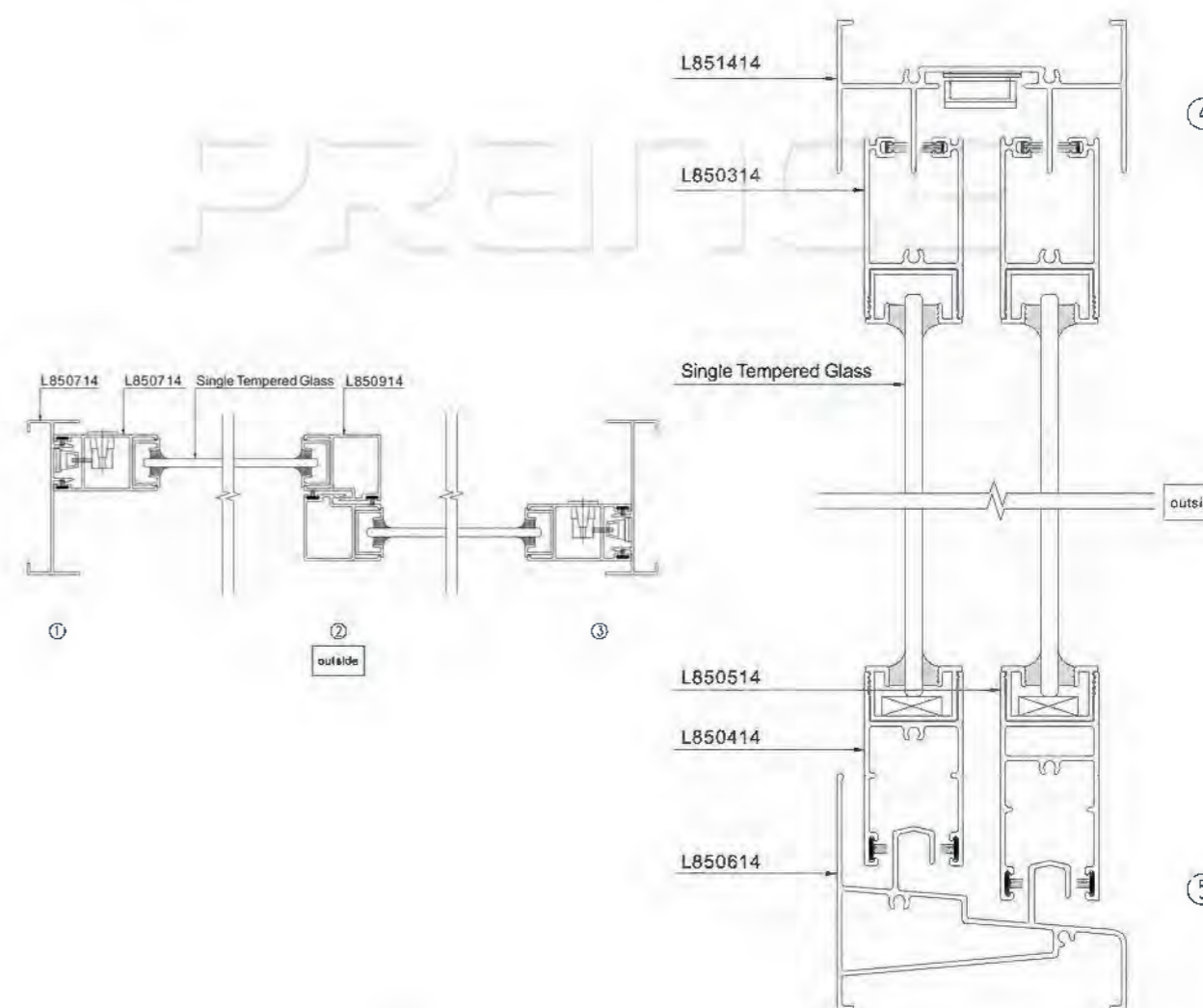
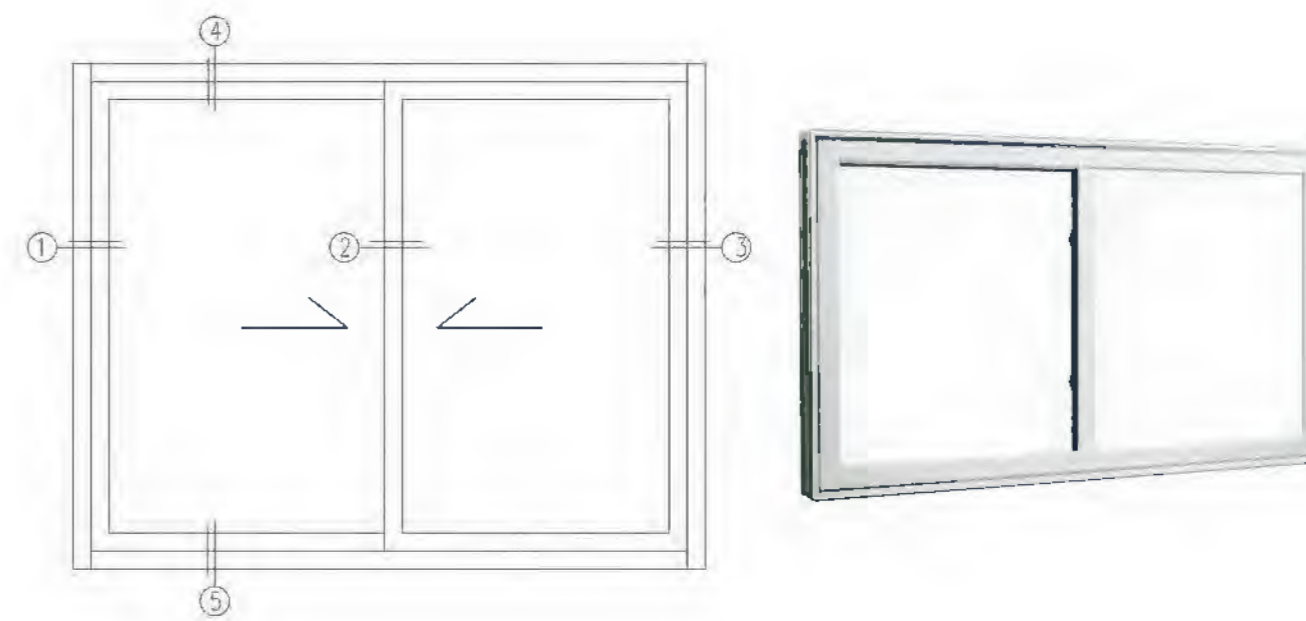

PRODUCT INSTRUCTION

Model: L85 double hung window

Surface Treatment: PVDF Coating; Powder Coating; Anodized; Electrophoretic Coating

Profile Thickness: Window: 1.4mm; Door: 2.0mm

Material of Profile: 6063/T5、6063/T6

Glass Selection: Tempered Glass/Resective Coated Glass(5、6、8、10), Tempered Insulated Glass

Units(5+9A+5、6+9A+6)

Hardware Selection: Chinese and German hardware are available(Kin Long、HeHe、Roto)

Applicable Range: Factory, Dormitories and other properties of the building envelope system.

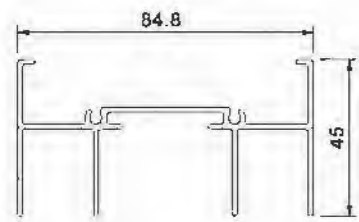

Upper Groove L851414
T=1.4mm 0.991kg/m

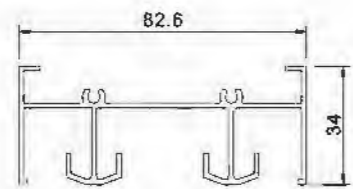

Bottom Groove L850314
T=1.4mm 1.43kg/m

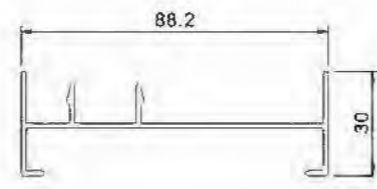

Edge L850714
T=1.4mm 0.698kg/m

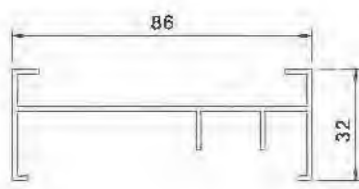

Edge L85A0814
T=1.4mm 0.716kg/m

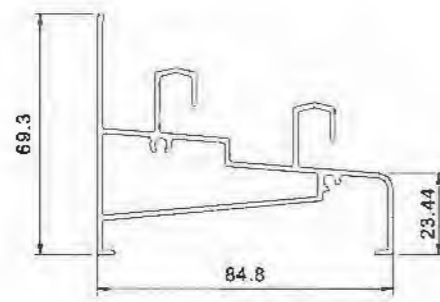

Bottom Groove L850614
T=1.4mm 1.323kg/m

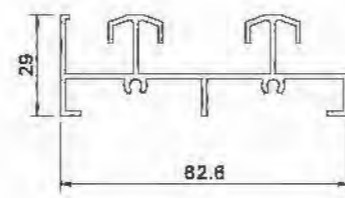

Bottom Groove L850614
T=1.4mm 0.925kg/m

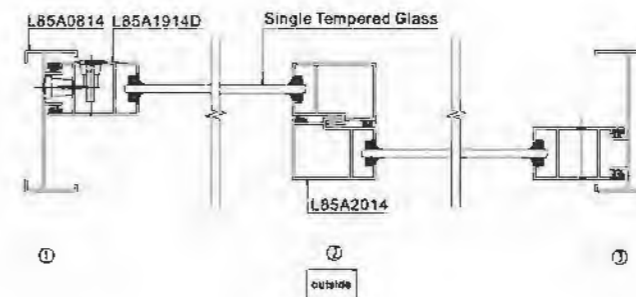
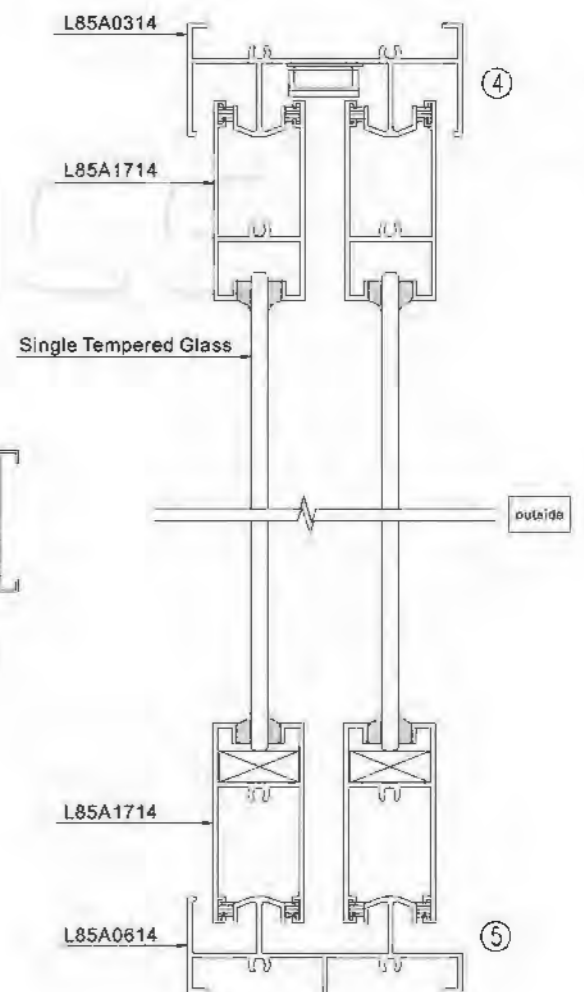
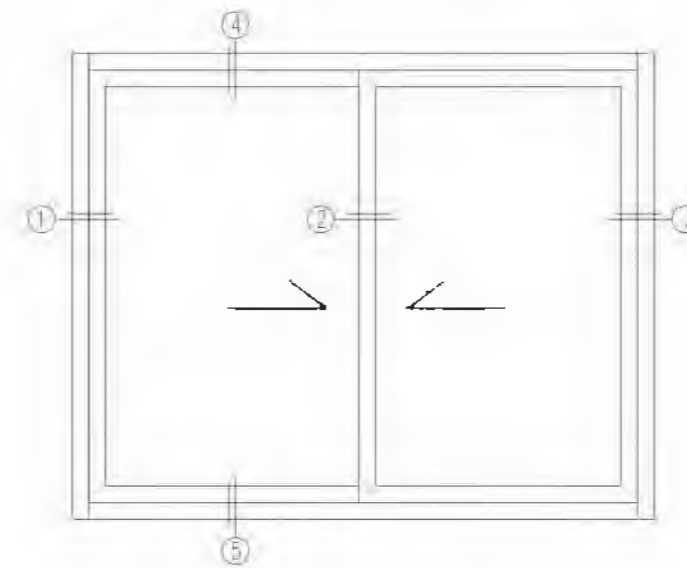

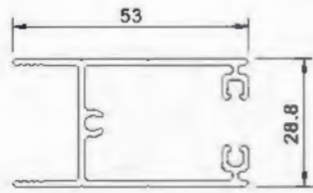

Above L850314
T=1.4mm 0.653kg/m

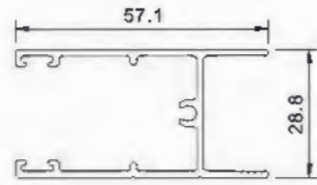

Below L850414
T=1.4mm 0.631kg/m

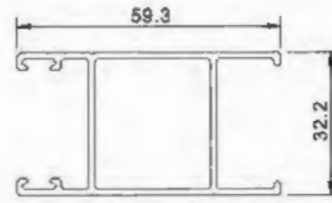

Lighting Frame L850814
T=1.4mm 0.739kg/m

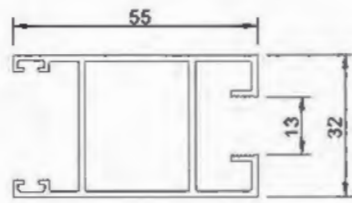

Lighting Frame L85A1914D
T=1.4mm 0.771kg/m

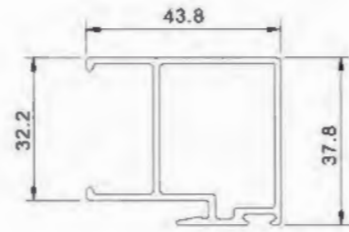

Hook Frame L850914
T=1.4mm 0.665kg/m

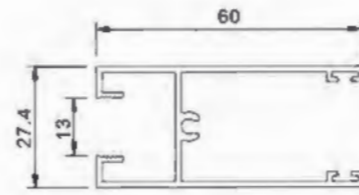

Single Tempered Glass Above
L85A1714
T=1.4mm 0.704kg/m

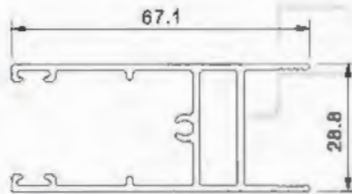

Below L850514
T=1.4mm 0.807kg/m

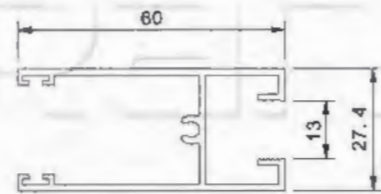

Single Tempered Glass Below
L850514
T=1.4mm 0.704kg/m



Hollow Glass Groove
T=1.4mm 0.282kg/m

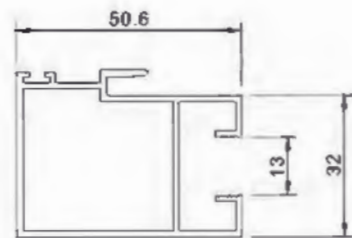

Hook Frame L85A2014
T=1.4mm 0.798kg/m



The use of high quality slide rails. A small push can open the door smoothly. Window sash contains a strong supporting for, so it's not easy to wreck.

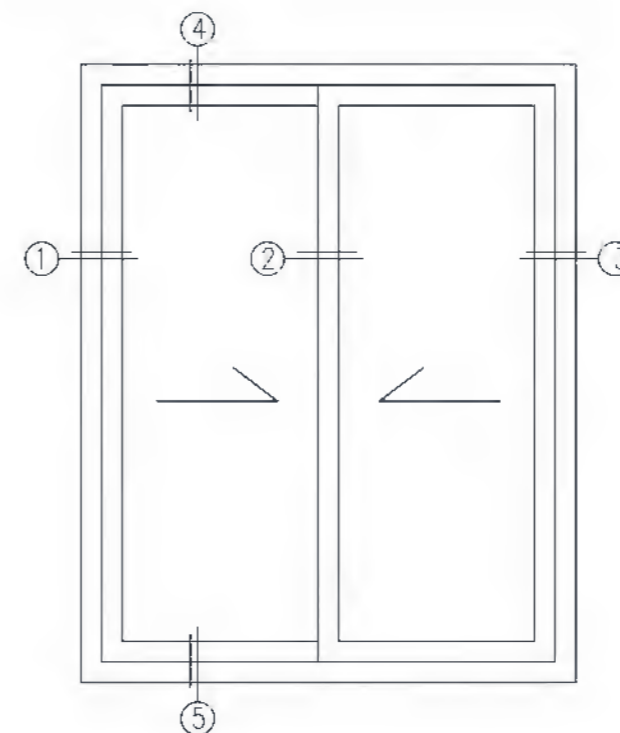

105

106

PRODUCT INSTRUCTION

Model: 88C double hung window
Surface Treatment: PVDF Coating; Powder Coating; Anodized; Electrophoretic Coating
Profile Thickness: Window: 1.4mm; Door: 2.0mm
Material of Profile: 6063/T5、6063/T6
Glass Selection: Tempered Glass/Resective Coated Glass(5、6、8、10), Tempered Insulated Glass Units(5+9A+5、6+9A+6)
Hardware Selection: Chinese and German hardware are available(Kin Long、HeHe、Roto)
Applicable Range: Factory, Dormitories and other properties of the building envelope system.

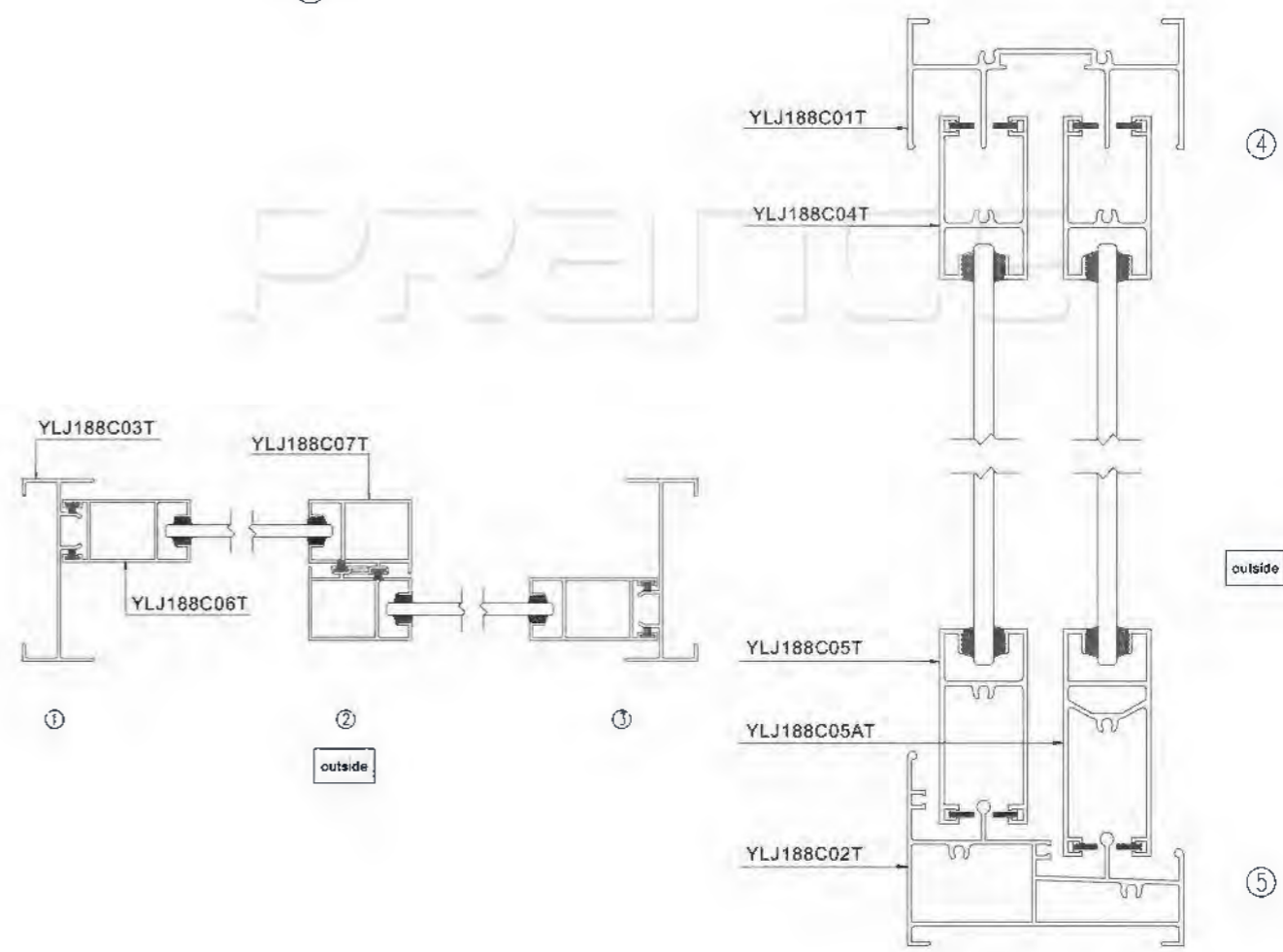

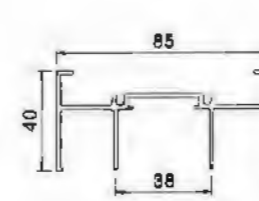
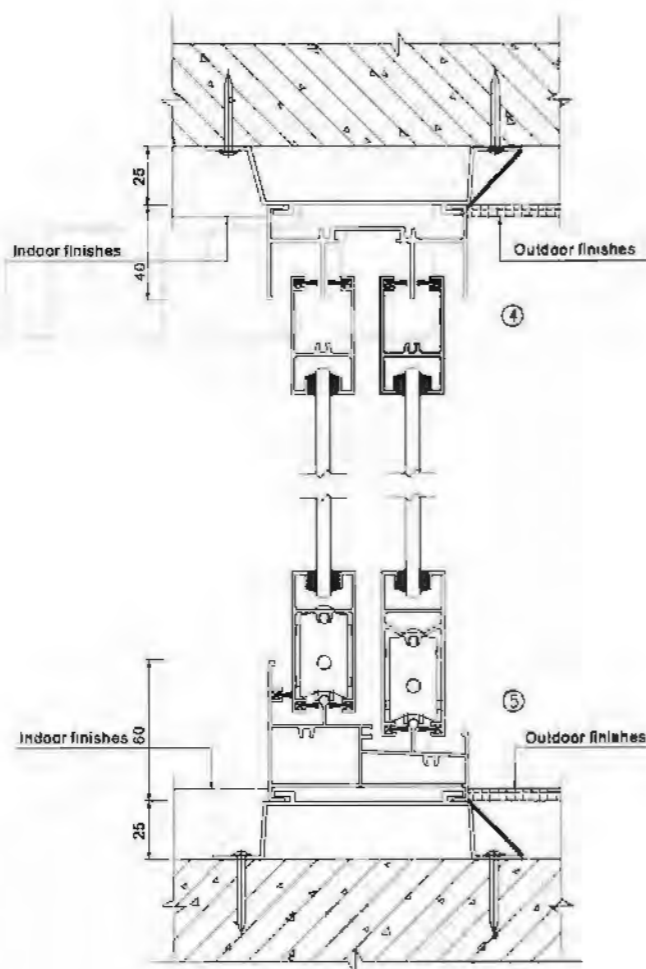
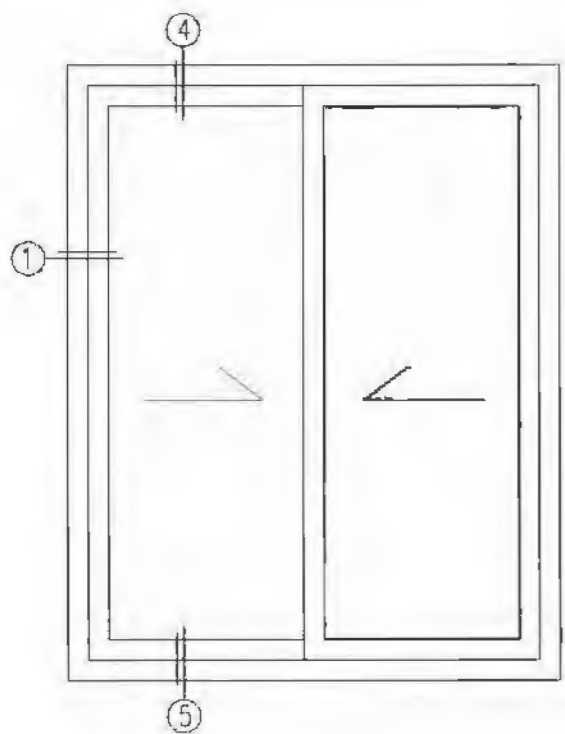

Upper Rail YLJ188C01T
T=1.45mm 0.99kg/m

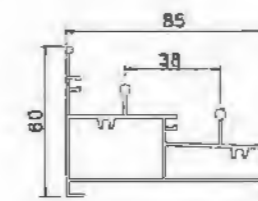

Bottom Rail YLJ188C02T
T=1.45mm 1.454kg/m

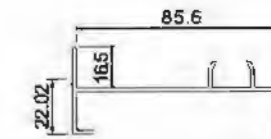

Edge Seal YLJ188C03T
T=1.45mm 0.753kg/m

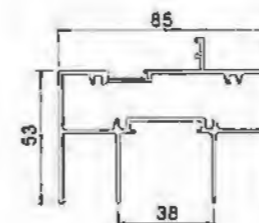

Middle Upper Rail
YLJ188C01AT
T=1.45mm 1.565kg/m

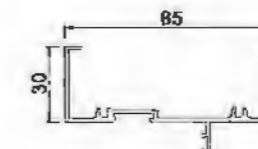

Upper Fixed Material
YLJ188C14T
T=1.45mm 0.774kg/m

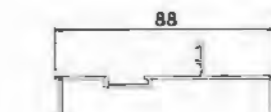

Edge Seal Cover
YLJ188C11T
T=1.45mm 1.554kg/m

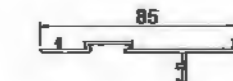

Edge Seal Cover
YLJ188C12
T=1.26mm 0.418kg/m

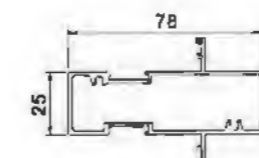

Middle Fixed Material
YLJ188C13T
T=1.45mm 1.037kg/m

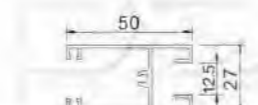

Above YLJ188C04T
T=1.45mm 0.674kg/m

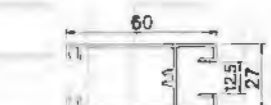

Inner Below YLJ188C05T
T=1.45mm 0.752kg/m

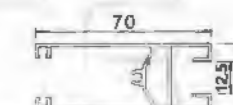

Outer Below YLJ188C05AT
T=1.45mm 0.937kg/m

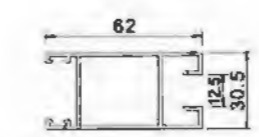

Lighting Frame YLJ188C06T
T=1.45mm 0.847kg/m

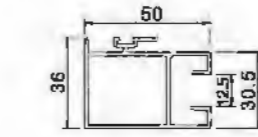

Hook Frame YLJ188C7T
T=1.45mm 0.815kg/m

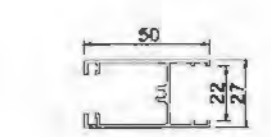

Above YLJ188C04TZK
T=1.45mm 0.605kg/m

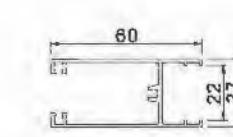

Inner Below YLJ188C05TZK
T=1.45mm 0.683kg/m

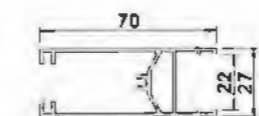

Outer Below YLJ188C05ATZK
T=1.45mm 0.867kg/m

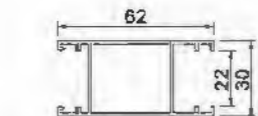

Lighting Frame YLJ188C06TZK
T=1.45mm 0.79kg/m

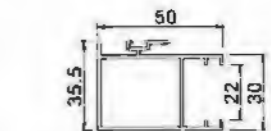

Hook Frame YLJ188C07TZK
T=1.45mm 0.755kg/m

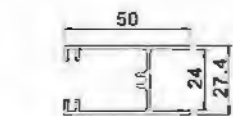

Above YLJ188C04BZK
T=1.4mm 0.593kg/m

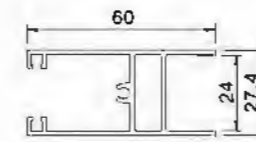
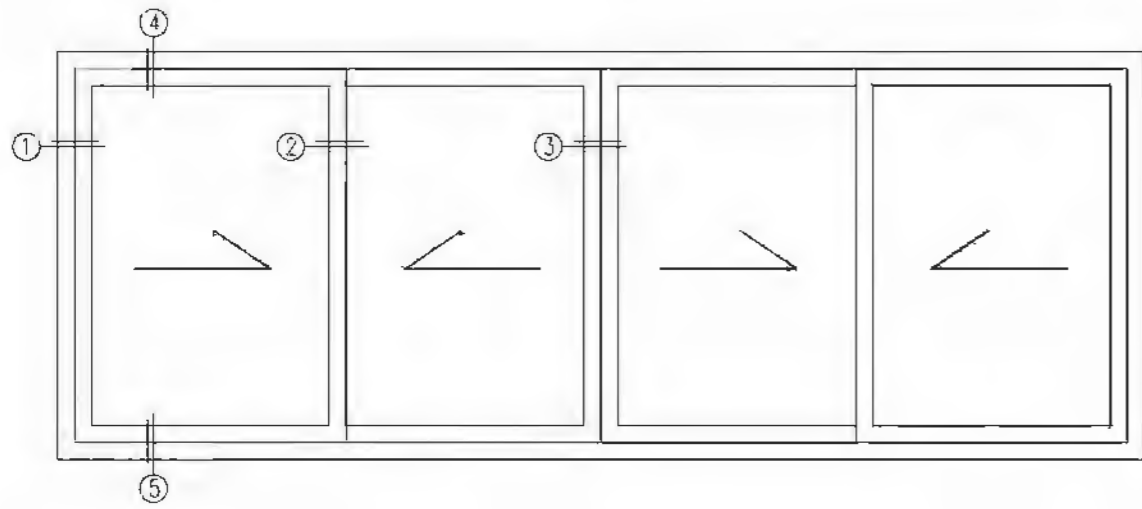

Below YLJ188C05BZK
T=1.4mm 0.766kg/m

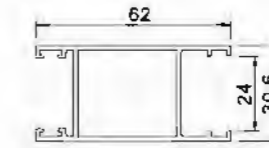

Lighting Frame YLJ188C06BZK
T=1.4mm 0.768kg/m

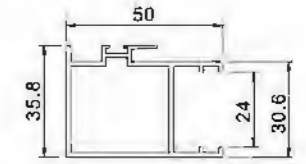

Hook Frame YLJ188C07BZK
T=1.4mm 0.71kg/m

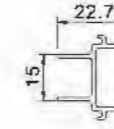

Close-up YLJ188C08
T=1.4mm 0.253kg/m

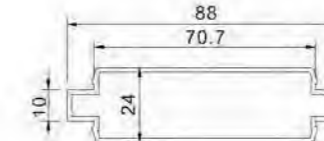

Connecting Tube YLJ188C10
T=1.4mm 0.895kg/m

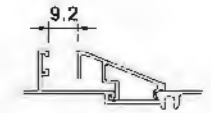

Fixed Glass Bead
YLJ18820
T=0.9mm 0.16kg/m

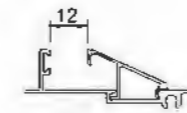

Fixed Glass Bead
YLJ23800N
T=0.8mm 0.119kg/m

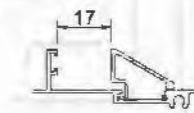

Fixed Glass Bead
YLJ23800
T=0.9mm 0.128kg/m

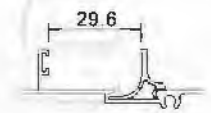

Fixed Glass Bead
YLJ23800H
T=0.9mm 0.091kg/m

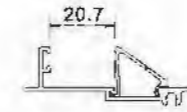

Fixed Glass Bead
YLJ23800G
T=0.9mm 0.112kg/m

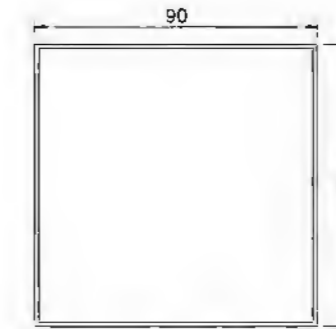

Corner Square Tube
90X90
T=1.25mm 1.211kg/m

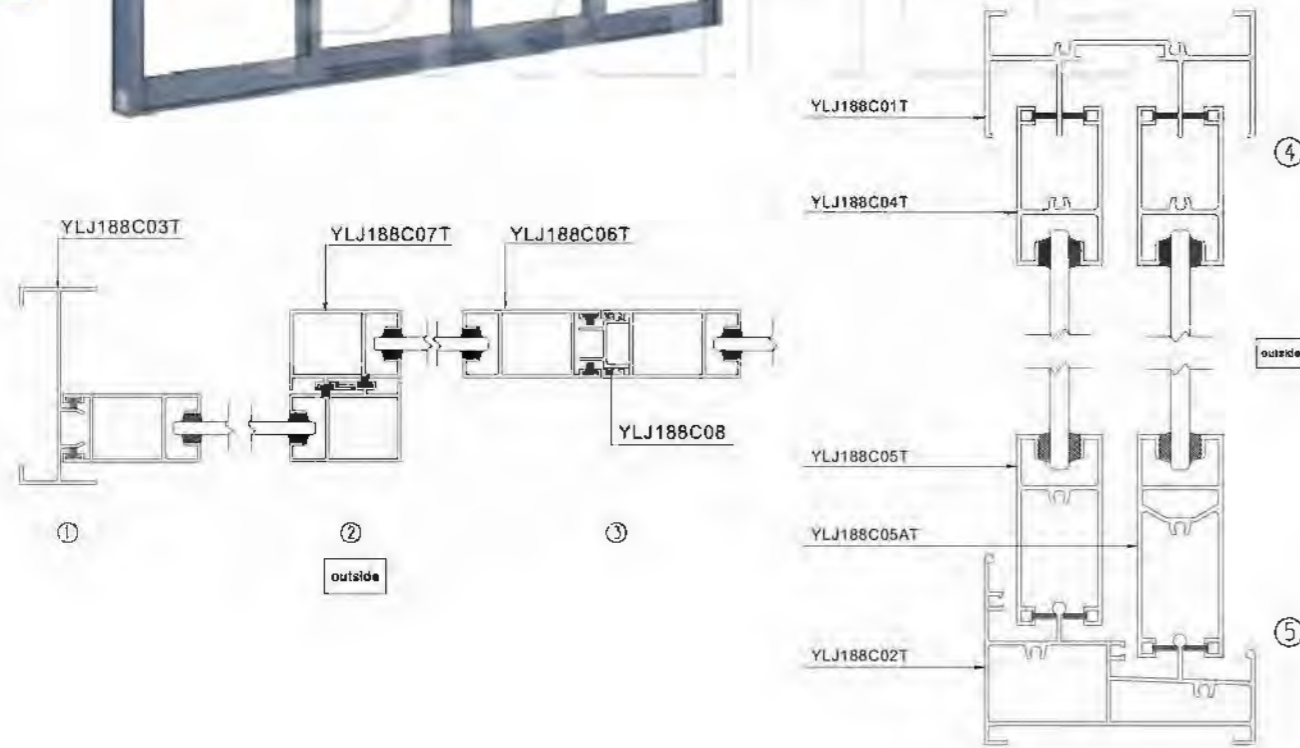

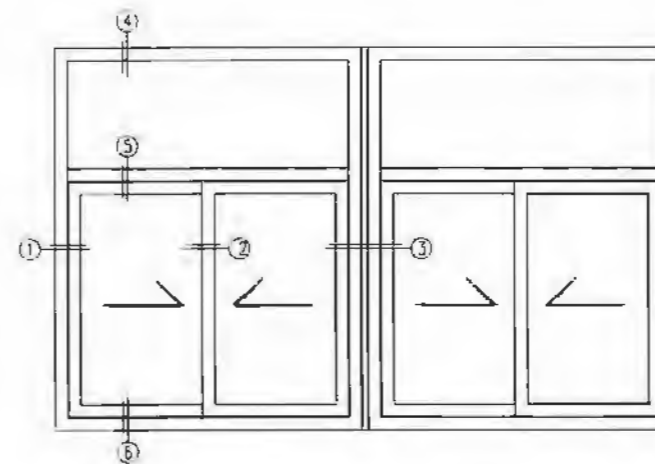
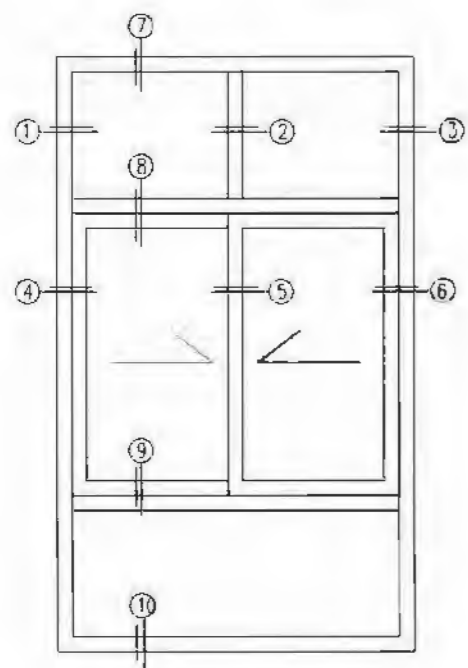

111

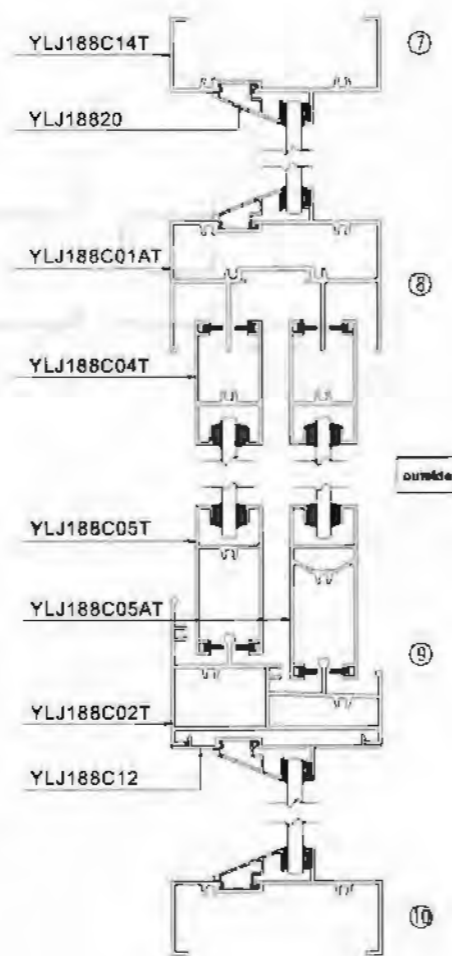
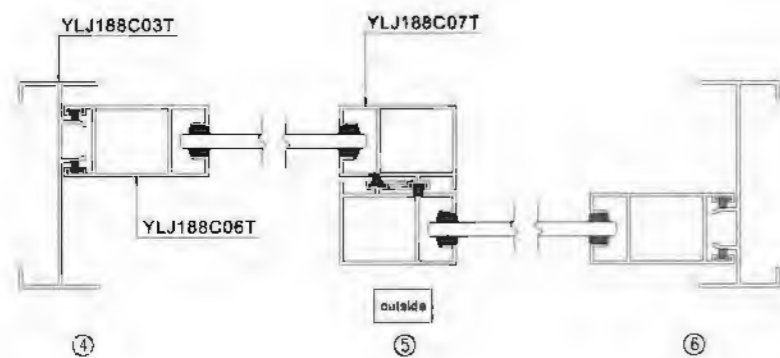
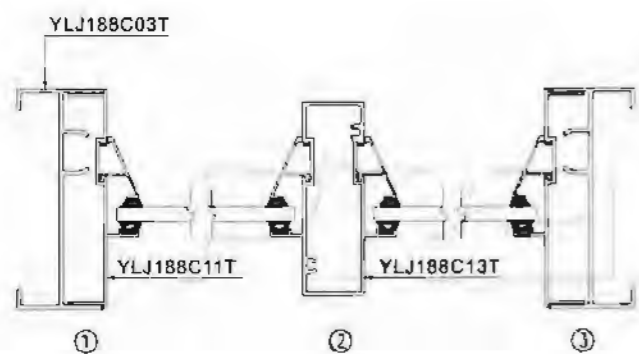

112

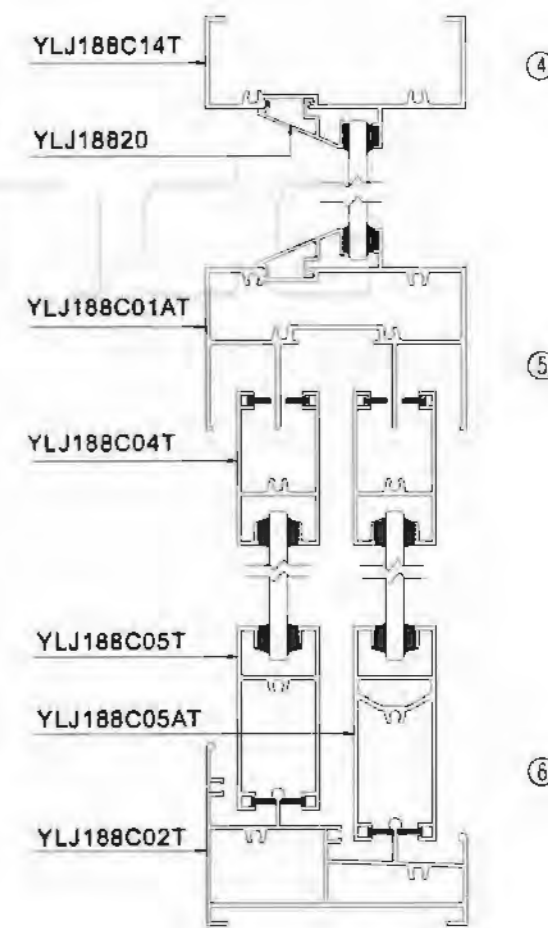
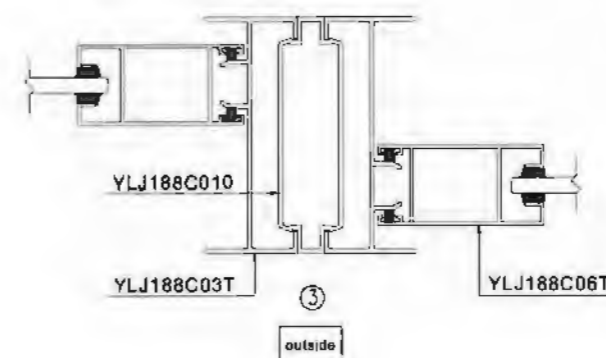
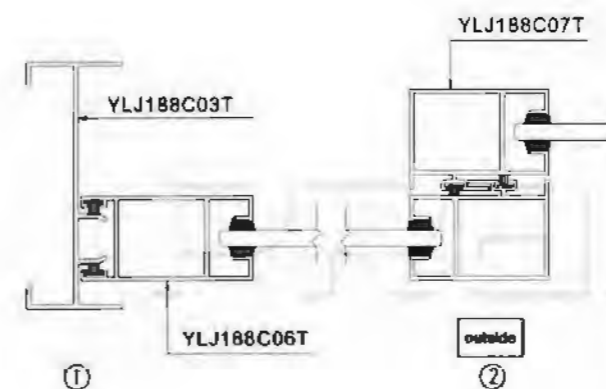

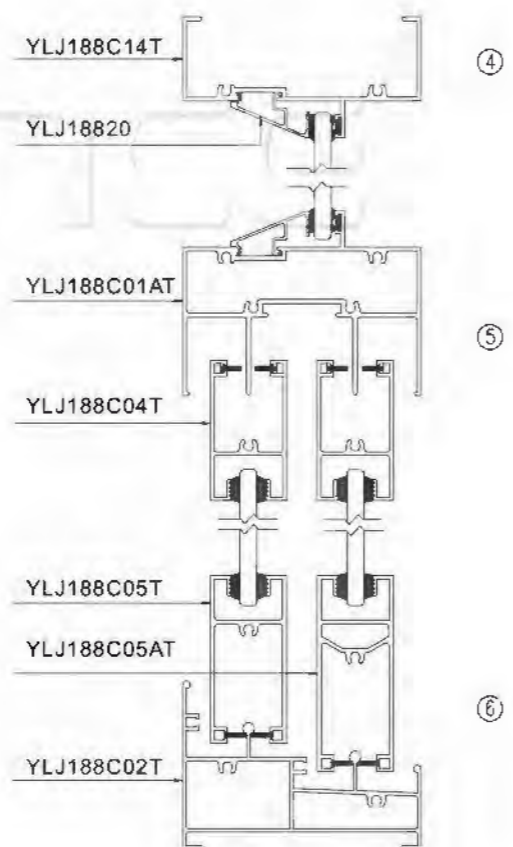
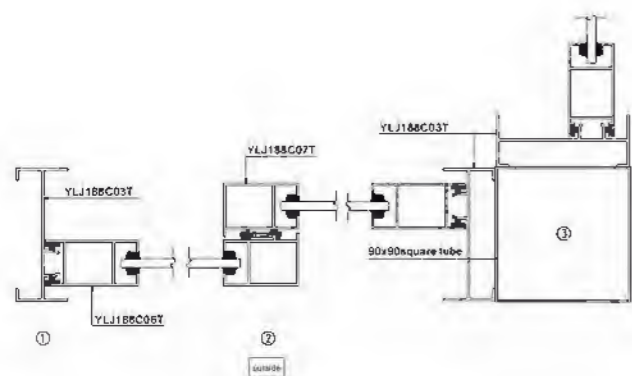
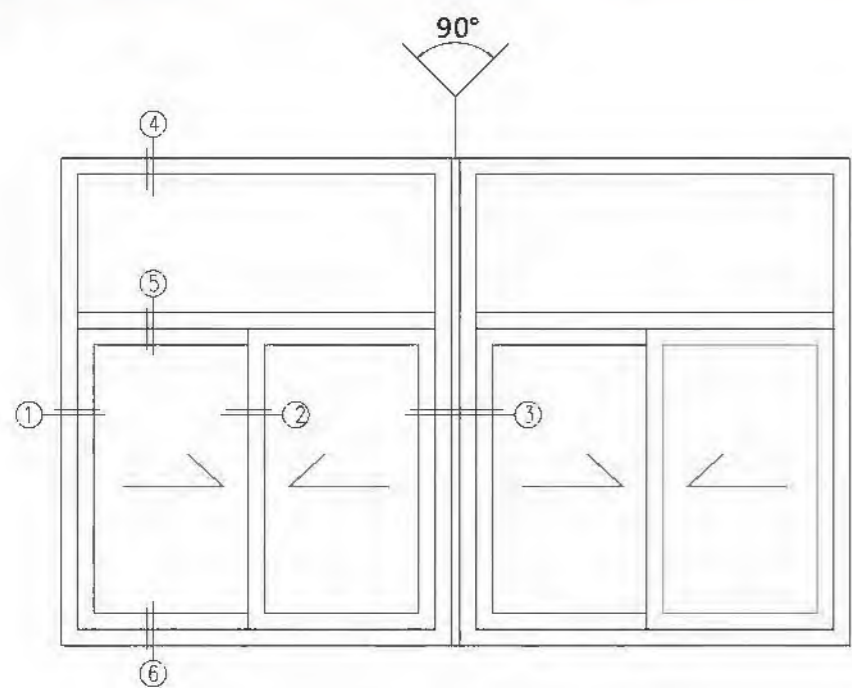



SHOWING

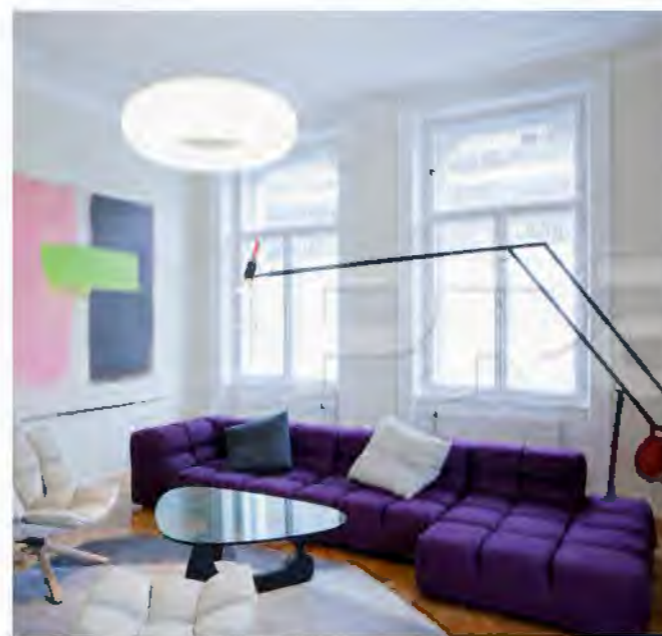

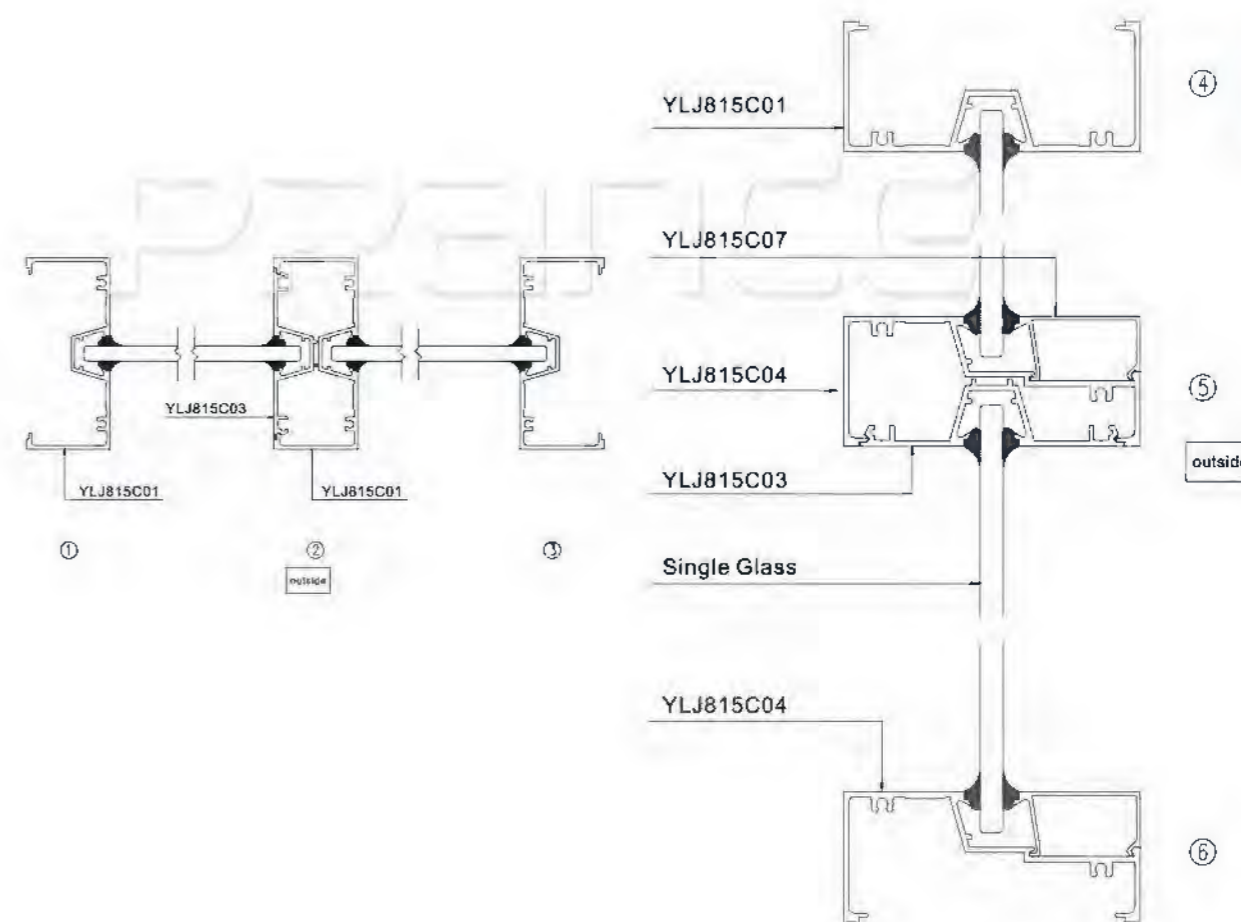
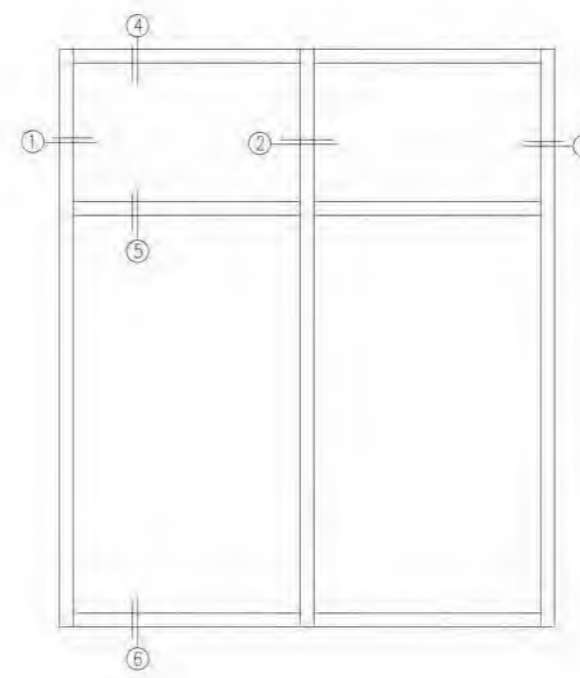

119

120

PRODUCT INSTRUCTION

Model: 815fixed window

Aluminum profile surface work: PVDF Coating (double/triple coating), Powder Coating, Anodization, coloring electrophoresis. Two choices can be used combine.

Aluminum profile surface color choices: PVDF Coating (Powder Coating): choice of color is plenty, depends on the need of customer.

Anodization: Choice of color is not many, mainly silver, titanium, bronze, black, champagne .

Coloring electrophoresis coating: silver, champagne, golden, black, color imitation stainless steel.

Width of aluminum profile: Window profile(standard) 1.4mm; Door profile(standard) 2.0mm. Non-standard width can be molded depends on the situation of a project or a specific product.

Aluminum profile material: 6063/T5, 6063/T6

Choice of color: Hollow temper glass/Hollow temper film coating glass/Hollow LOW-E temper film coating glass (5+9A+5, 6+9A+6, 5+12A+5, 6+12A+6, 8+12A+8 etc.)

Choice of Hardware: Top Chinese Brand (KIN LONG, HEHE) ; Top World-wide Brand (Roto-frank, Siegenia)

Other materials: (Sealants, tapes) use Chinese top brands

Application Scale: Mall ground floor, office buildings, houses, villas, apartments, schools, hospitals, large factories, and other properties of the envelope system

This structure is especially suitable for following situation: Window is large, container loading is difficult, products split for easier delivery.

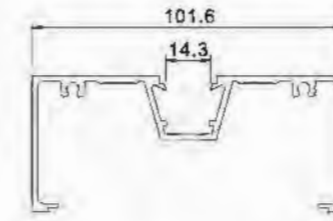
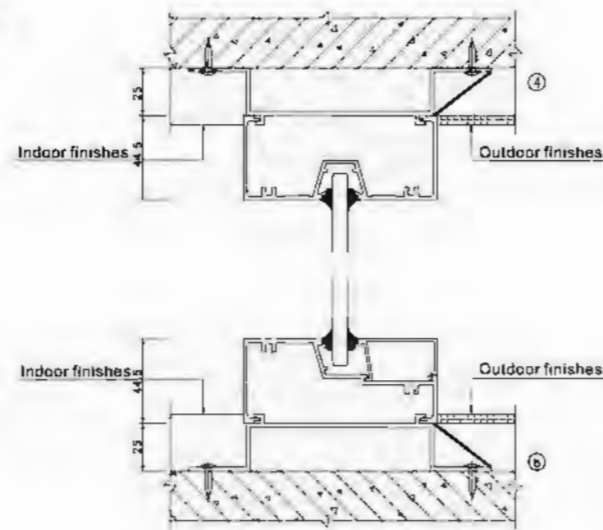
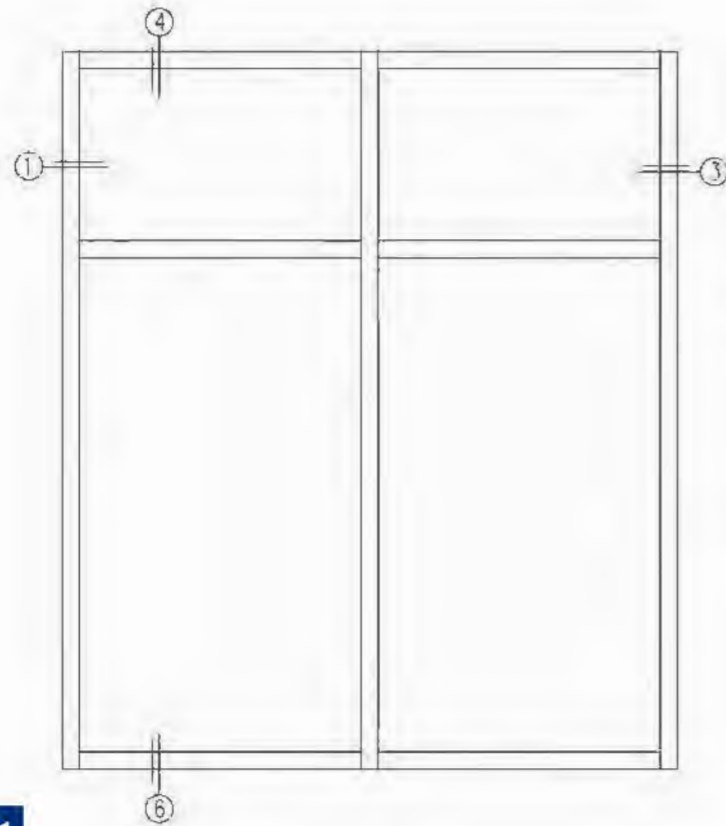

YLJ815C01
T=1.8mm 1.4kg/m

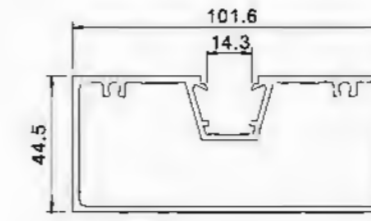

YLJ815C02
T=1.8mm 1.91kg/m

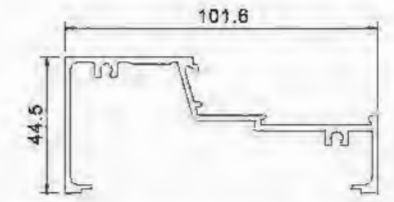

YLJ815C04
T=1.8mm 1.197kg/m

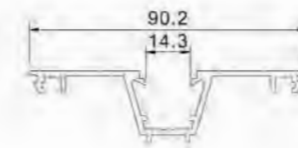

YLJ815C03
T=1.8mm 0.781kg/m

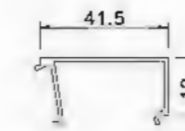

YLJ815C07
T=1.2mm 0.314kg/m

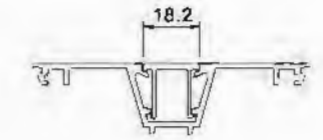

YLJ815C07
T=1.2mm 0.314kg/m

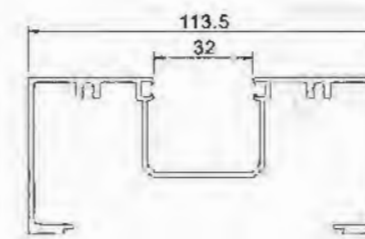
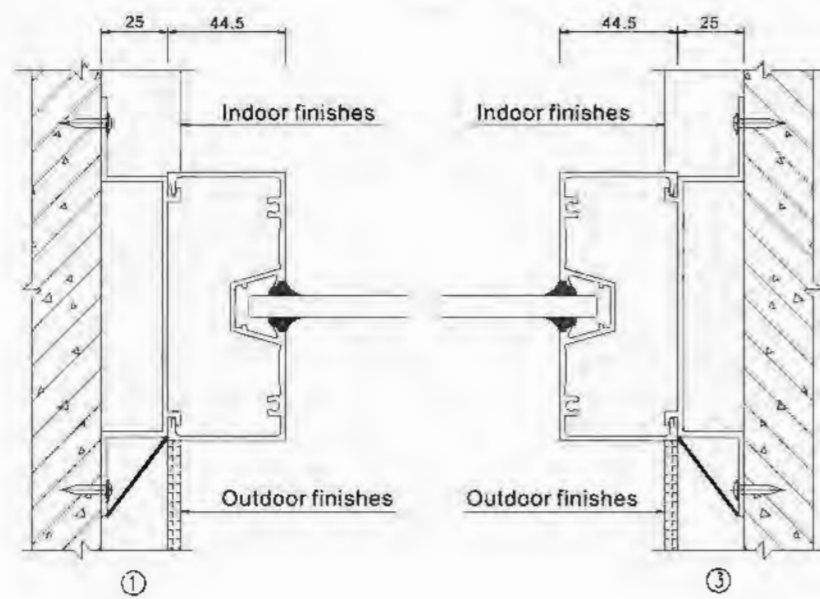

YLJ81550
T=1.6mm 1.551kg/m

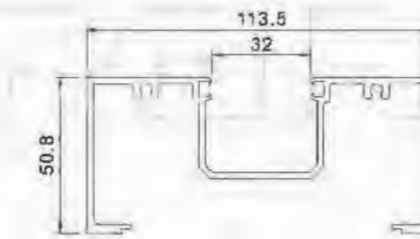

YLJ81550A
T=2.0mm 1.871kg/m

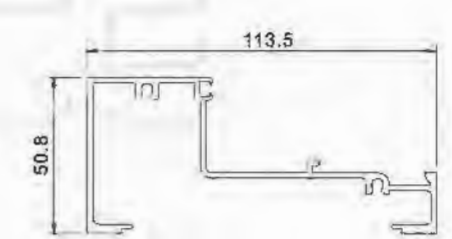

YLJ81551
T=1.8mm 1.399kg/m

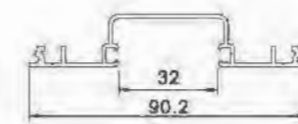

YLJ81554
T=1.2mm 0.558kg/m

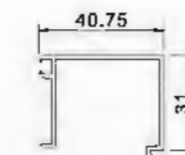

YLJ81558
T=1.4mm 0.442kg/m

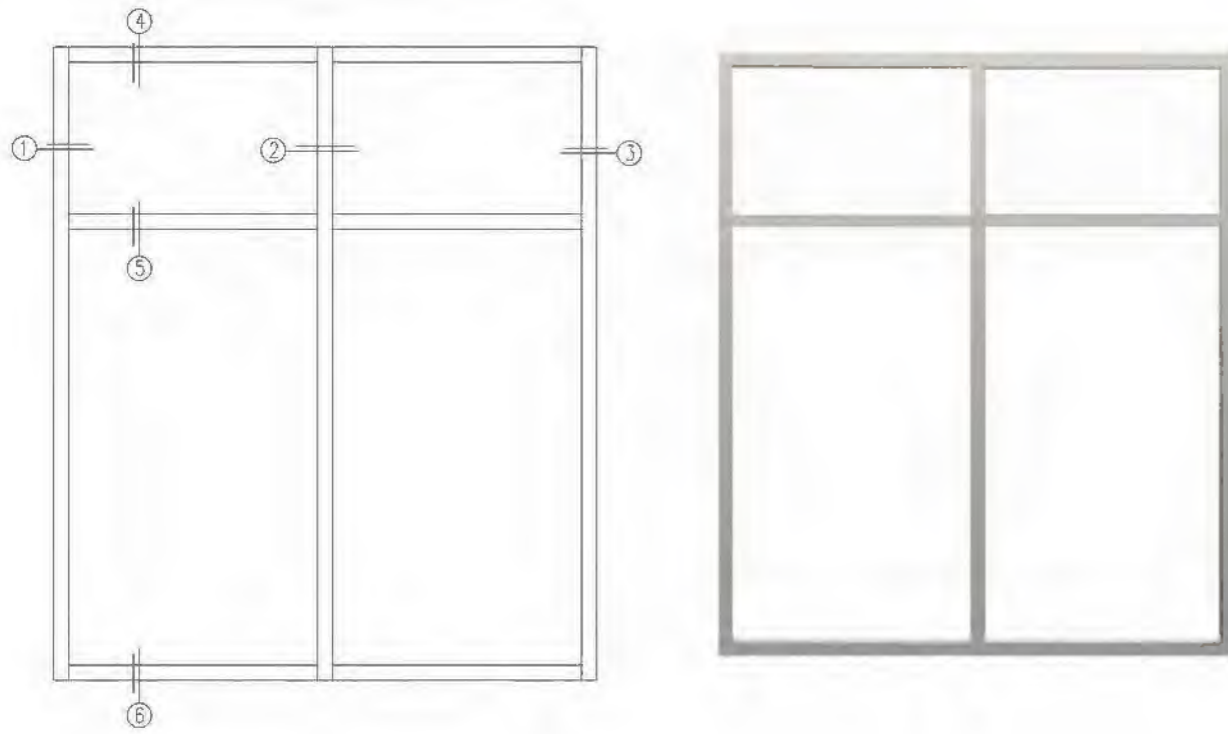

123

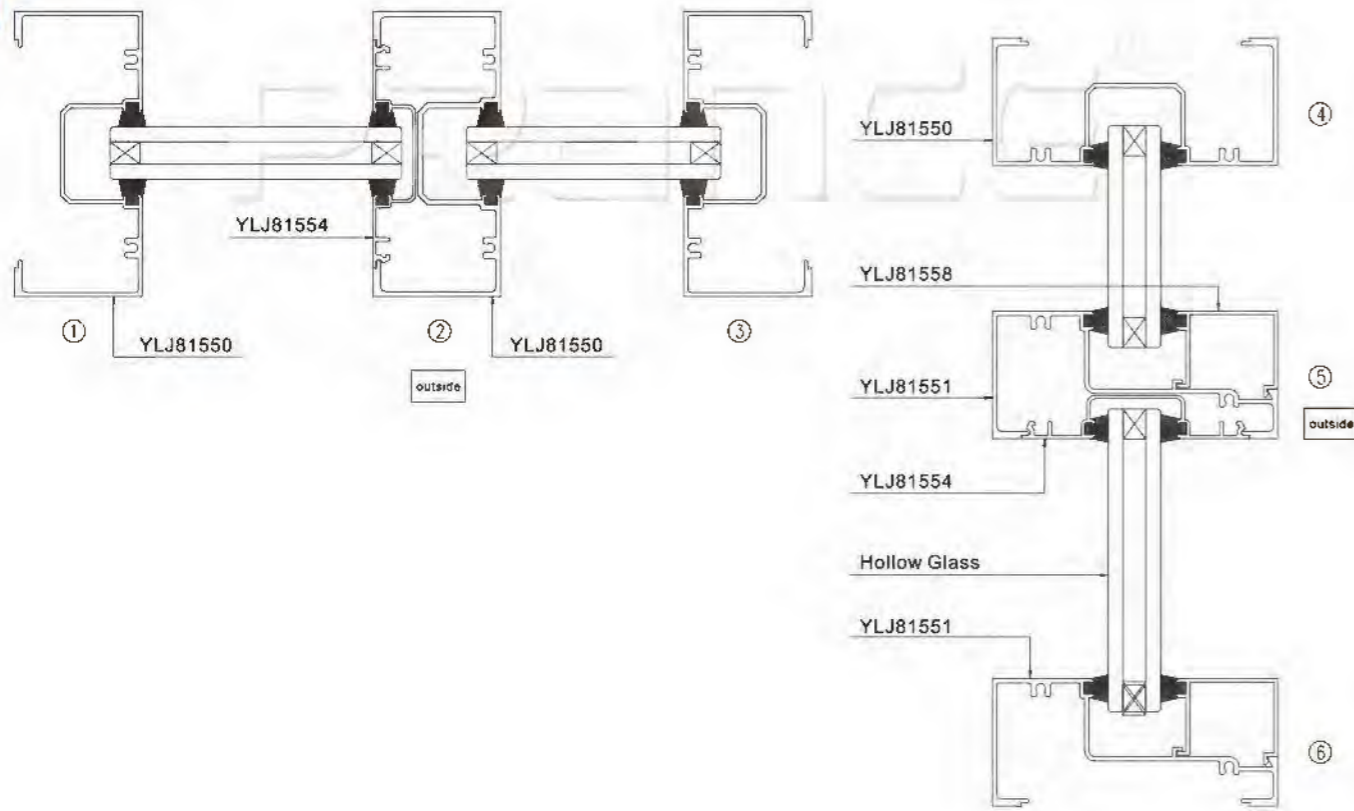



SHOWING

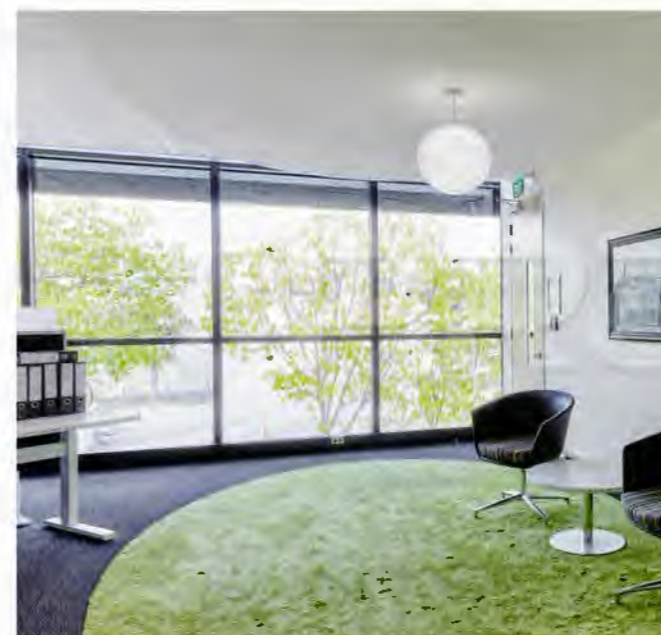

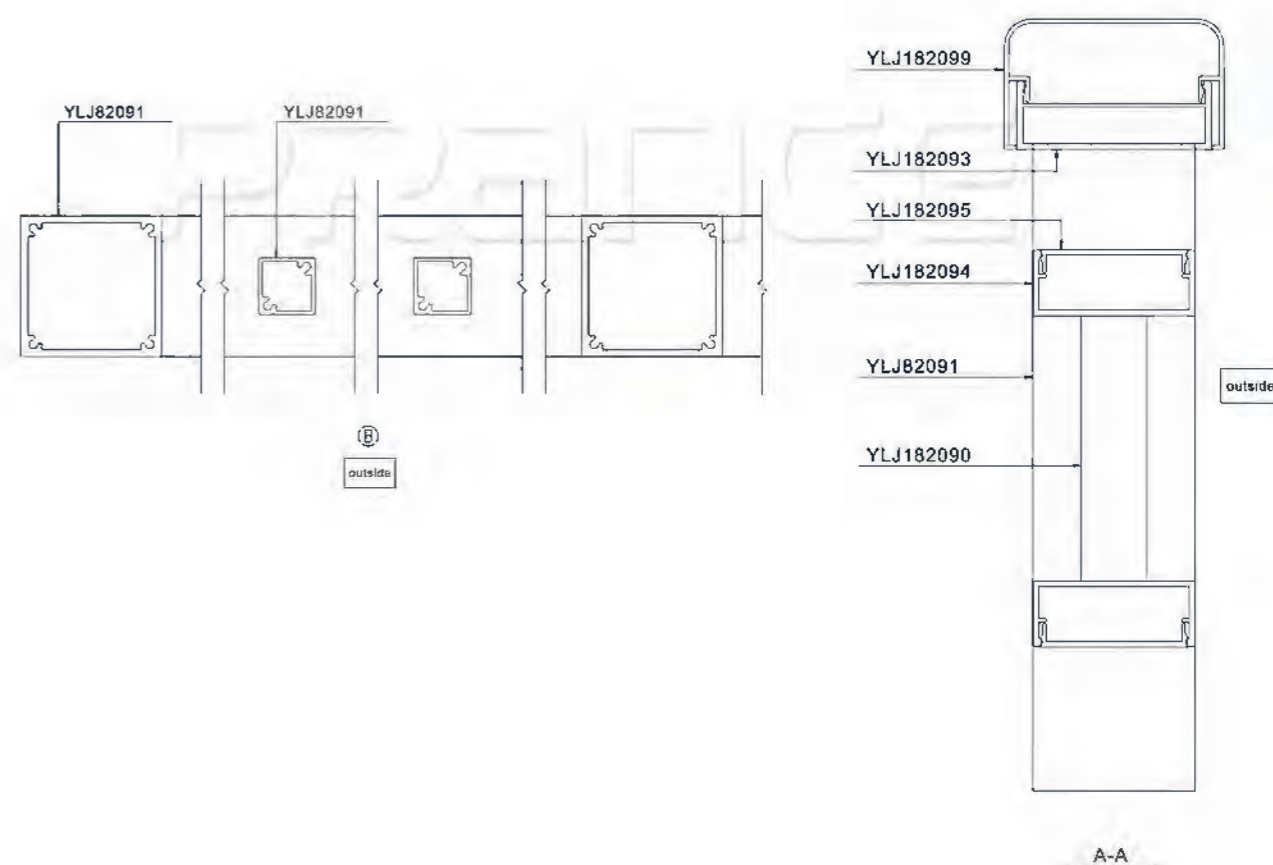

125

126

PRODUCT INSTRUCTION

Model: handrail

Aluminum profile surface work: PVDF Coating (double/triple coating), Powder Coating, Anodization, coloring electrophoresis. Two choices can be used combine.

Aluminum profile surface color choices: PVDF Coating (Powder Coating): choice of color is plenty, depends on the need of customer.

Anodization: Choice of color is not many, mainly silver, titanium, bronze, black, champagne.

Coloring electrophoresis coating: silver, champagne, golden, black, color imitation stainless steel.

Aluminum profile standpipe distance of space: not less than 110mm. Width depends on the situation of a project (mm).

Aluminum profile standpipe connection: After bury (rear steel plate + chemical bolts) or embedded parts connection

Other materials: (Sealants, tapes) use Chinese top brands

Application Scale: Mall ground floor, office buildings, houses, villas, apartments, schools, hospitals, large factories, and other properties of the envelope system

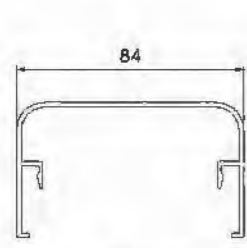

Handrail YLJ82099
T=1.7mm 0.966kg/m

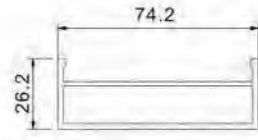

Handrail Base YLJ82093
T=2.2mm 1.028kg/m

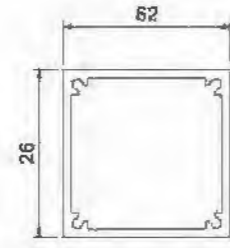

Column YLJ82091
T=3.0mm 2.106kg/m

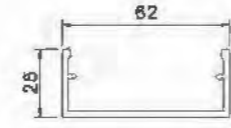

Fence Crossbar YLJ82094
T=2.2mm 0.685kg/m

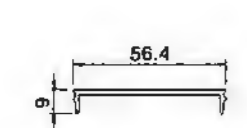

Fence Crossbar Seal Cover
YLJ82095
T=2.0mm 0.358kg/m

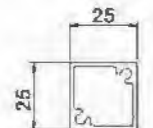

Pole YLJ82090
T=1.6mm 0.495kg/m

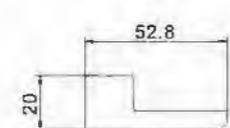

Glass Clamp YLJ01900
T=1.7mm 1.619kg/m

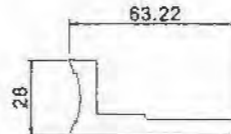

Glass Clamp YLJ01901
T=6mm 1.508kg/m

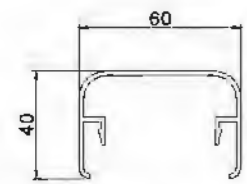
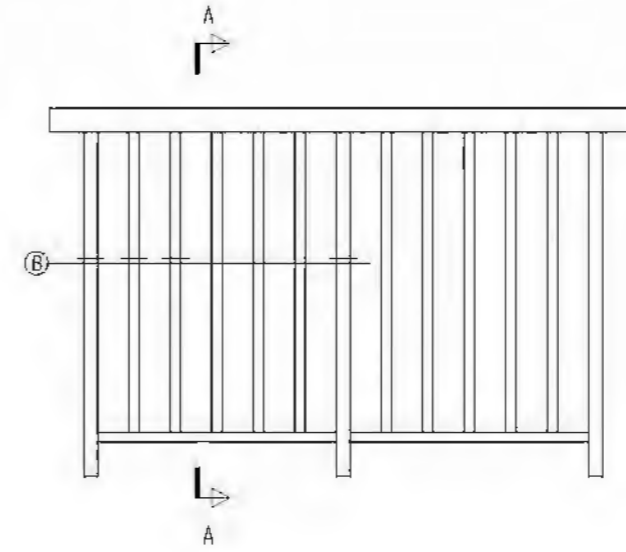

Handrail YLJ82011
T=1.7mm 0.752kg/m

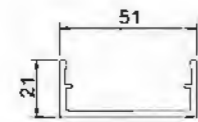

Handrail Base YLJ82012
T=2.2mm 0.578kg/m

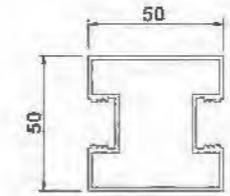

Column FS-003
T=1.4mm 0.968kg/m



Column Seal Cover
FS-005
T=1.0mm 0.081kg/m

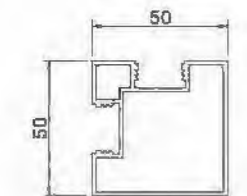

Corner Column FS-004
T=1.4mm 0.995kg/m

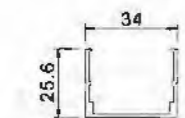

Fence Crossbar FS-007
T=1.4mm 0.363kg/m

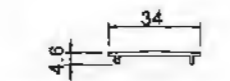

Fence Crossbar Seal Cover
FS-008
T=1.4mm 0.178kg/m

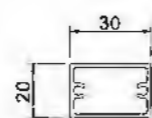

Column FS-006
T=1.4mm 0.416kg/m

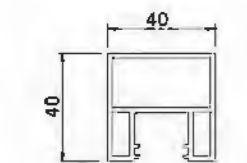

Glass Fence Crossbar
YLJ82115
T=1.8mm 1.003kg/m

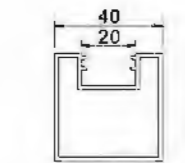

Glass Fence Crossbar
YLJ82115H
T=1.6mm 0.8kg/m

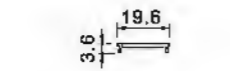

Seal Cover YLJ82119A
T=1.5mm 0.082kg/m

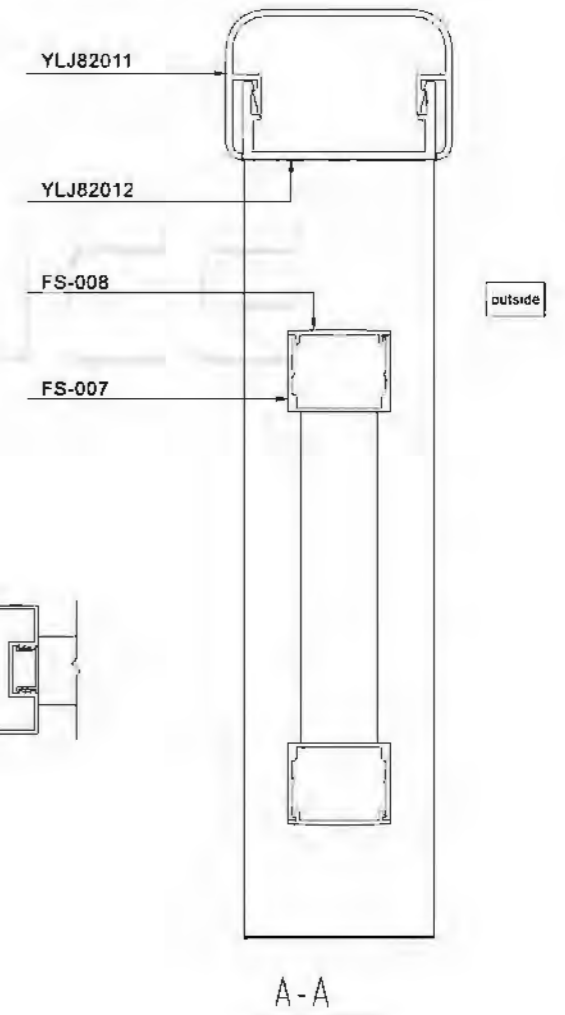
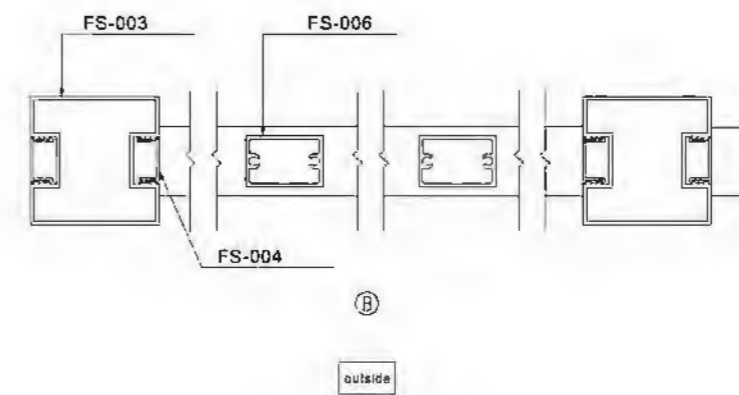

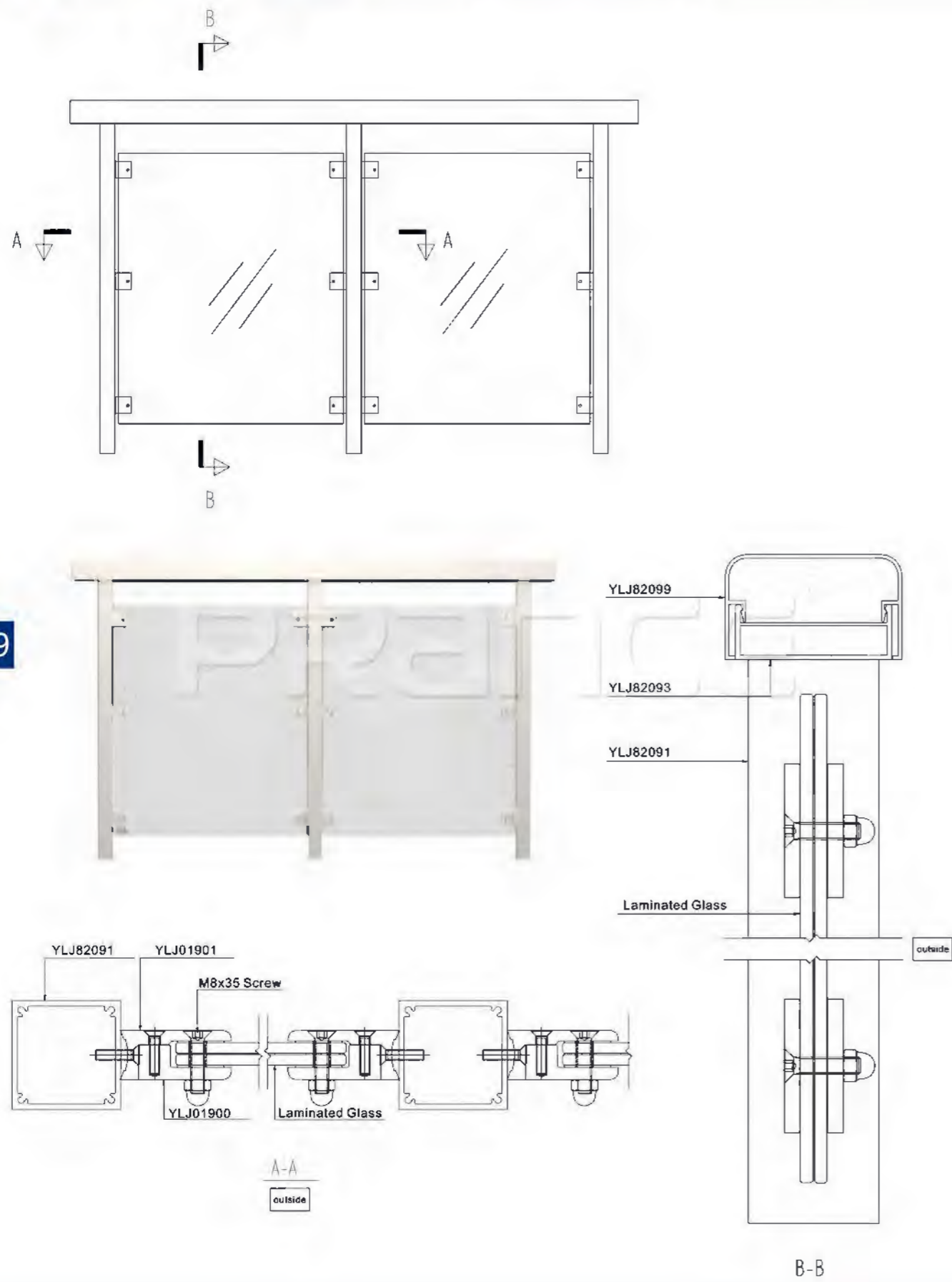

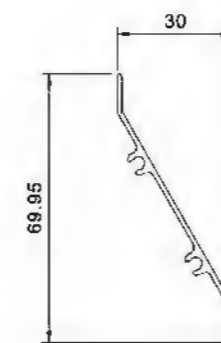
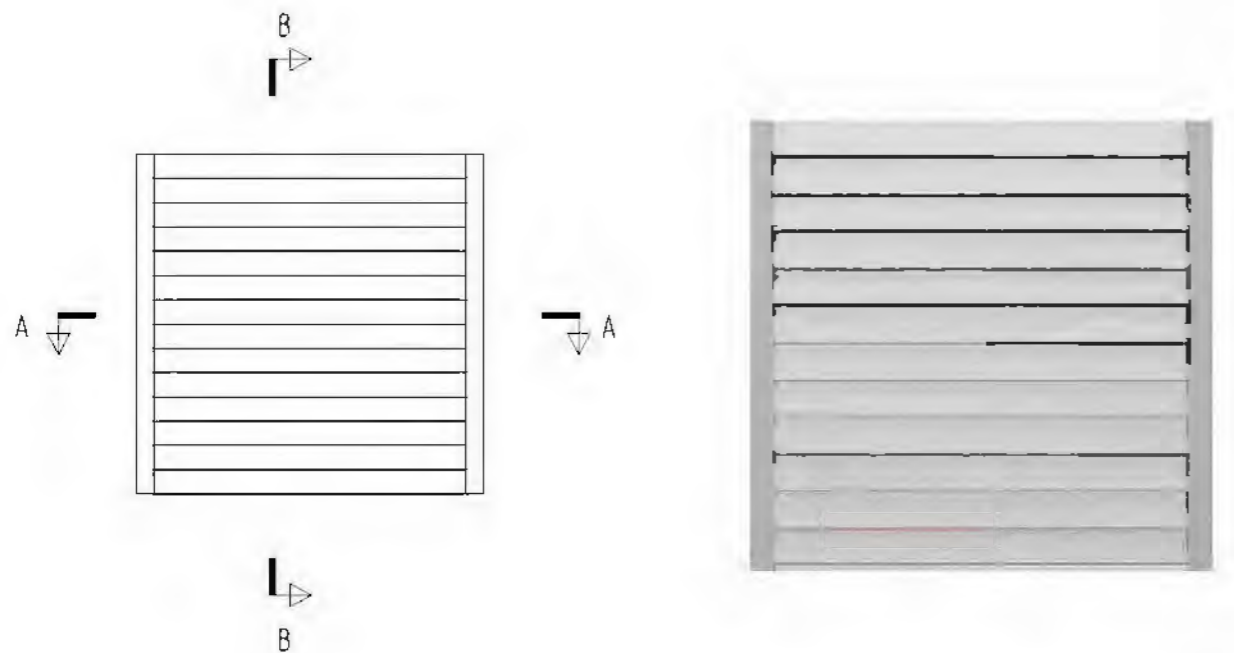

YLJ84002A
T=1.2mm 0.325kg/m

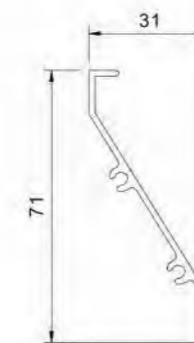

YLJ84003
T=1.5mm 0.425kg/m

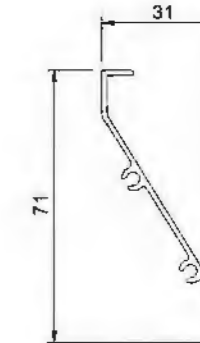

YLJ84003B
T=1.3mm 0.375kg/m

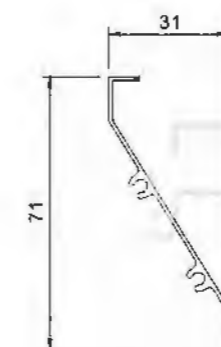

YLJ84003P
T=1.0mm 0.312kg/m

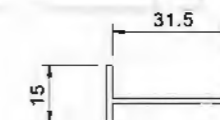

YLJ84095
T=1.5mm 0.251kg/m

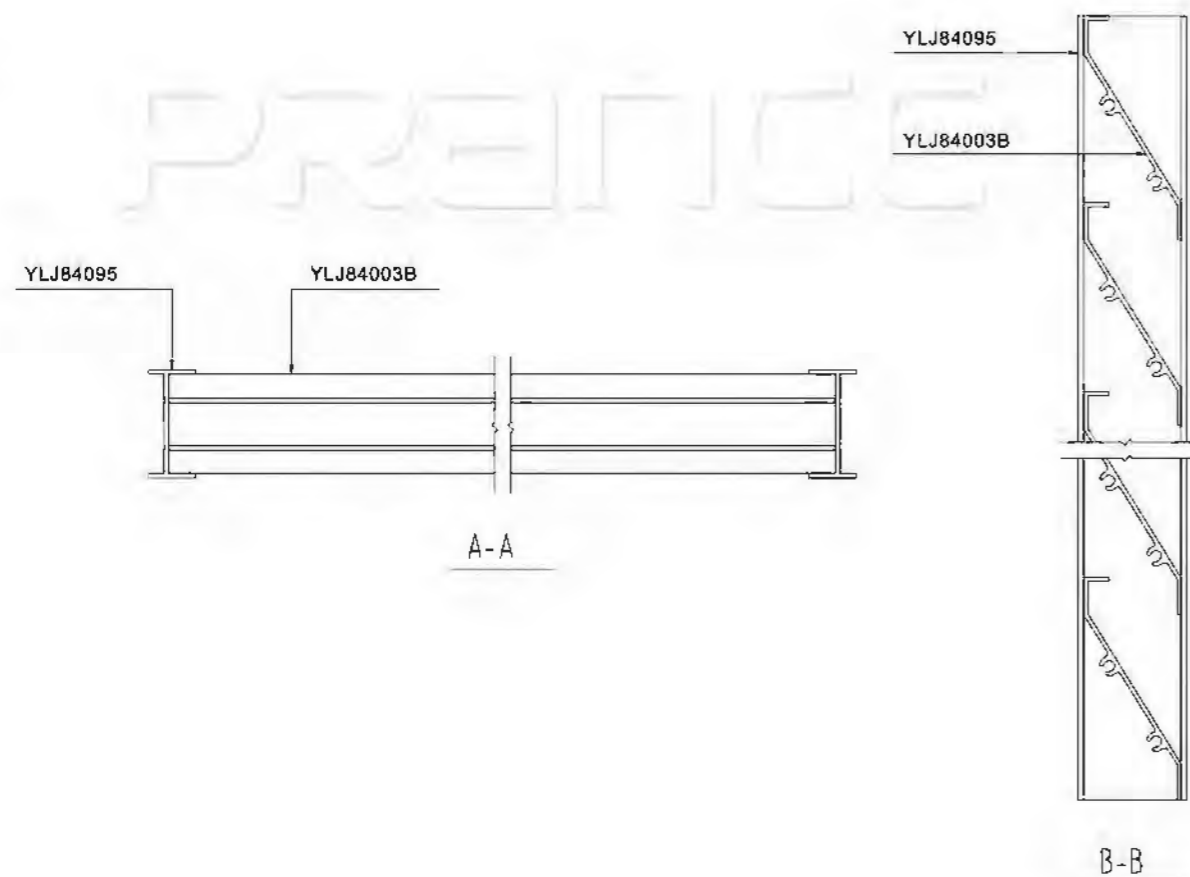



Production center:

No 169, South Area, Base of Electrical and Electronic Industry(National Touch Program)

OfficeAdd:

Room1701, 17/F, Tower2, District1, WorldwideComplex, Jihua 6th Road, ChanchengFoshan, Guangdong, China.

TEl:+86-757-83138155 +86-757-88334783

fax:+86-757-83139722

e-mail:info@prancebuilding.com

Http://www.prancebuilding.com

